

Welcome to your Vets2PM PMP® Boot Camp Plus Program!

Course Information



Your Provider & Support Team

Courses & Certifications

Get Training & Free Resources

Student Portal

DoD SkillBridge/CSP

Job Seekers

Talent Services

FAQs

Blog

PMP® & CAPM®

PMI-ACP®

Master Project
Leadership
Workshop

Scrum Master

Certified Manager

aPHR®

Cyber Professional

Get PDUs

Project Manager
Essential ToolBox
("PMET")

Subscription



Eric

Founder & CEO



Kelly

Director of Staff



Jeremy

Chief Operations Officer



Cathy

Director of Career Services



Garrik

Lead Instructor

Access to Proven Certification Training

SkillBridge Internship & Job Opportunities

Talent Services

Contact us! (First name... @vets2pm.com)

Student Introductions

[Courses & Certifications](#) [Get Training & Free Resources](#) [Student Portal](#) [DOD SkillBridge](#) [Job Seekers](#) [Talent Services](#) [FAQs](#) [Blog](#)

Tell us about you!

- Background/specialty
- What brought you to this PMP Course?
- Current project example
 - Temporary endeavor that creates a unique product/service/result
- Unique fact!

Class Agreement (i.e. Team Charter!)

Team Norms (shape the class dynamic):

1. Have open discussion (not just being briefed slides all week!)
2. Daily Standup
 - a) What you learned yesterday
 - b) What you want to learn today
 - c) What is an obstacle you are experiencing that inhibits your learning?
3. Hourly breaks
4. Daily lunch break
5. Shamelessly curious space (ask *all* the questions!)
6. Have fun, enjoy the process!

Ground Rules (“we commit to”):

1. Be on time
2. Practice professional language
3. Notify instructor if you need to miss class
4. Unanimous voting for any changes to class structure
5. Have fun, enjoy the process!

Course Objectives

- Teach you how to take and pass the PMP® exam, period.
 - Exam-taking techniques and tips
 - A *key* decision-making model to approach exam questions
 - The appropriate “lens” through which to take the exam
 - “How PMI® thinks; how they see PMs”
 - Methodology differences
 - Exam-centric topics throughout a sequential project flow:
 - Exam-preparation activities, questions, and practical tools
 - Holistic overview and conclusion

Course Summary

This course prepares you to pass the Project Management Institute (PMI)® PMP®/ CAPM® Exam, enter the field of project management, and use proven project management methodologies and tools in any industry; this course includes 35-hours worth of content, fulfilling PMP® requirements.

We use parallel military/civilian project examples, analogies, and terminology to solidify understanding of how to successfully approach behavioral-based PMI exam questions.

Although most veterans have a significant amount of project management experience from military service, the disciplined methodology used in effective civilian project management is notably different; this presents the opportunity for us at Vets2PM to provide a unique program instructed *by* veterans, *for* veterans!

This course will help you develop:

1. The ability to use the *PMI® Authorized PMP® Exam Prep* book for the PMP®/ CAPM® Exam;
2. An understanding of key project management-related concepts, tools, and terms;
3. Proven, expert exam-preparation and exam-taking skills.

Course Features

- **Baseline, Standard, or PMP®/CAPM®-Only Package**
- 35+ hours of instructor-led live training/study sessions, fulfills PMI® educational hour requirement
- Recorded, inclusive course review content
- PMI® Authorized PMP® Exam Prep book (digital)
- PMI® PMP®/ CAPM® application (use the Vets2PM® Application Completion Tool and OnDemand course)
- Full peace-of-mind PMI® application rejection/audit assistance
- Full color student guide (digital)
- Downloadable templates of project management plan components and project documents
- Parallel military/civilian project examples
- Proven, 30-day study plan
- Lifetime access to Vets2PM training resources and you can reattend live-virtual courses as many times as you want!
-
- **Included Career Services**
- Resume Builder Course to help you build your professional, project management-oriented, executive-style resume
- 4-hour Interview Skills Workshop, including 2 post-interview debriefs
- Lifetime membership to the *Vets2PM® Alumni* LinkedIn networking group
- Lifetime position placement assistance and secure, online resume posting to the Vets2PM® network of employer partners
- LinkedIn Optimization Course access



Course Materials

Vets2PM® uses the *PMI® Authorized PMP® Exam Prep* book (aka the Student Workbook).

Students are provided with a downloadable Student Guide which is available on the Vets2PM® Student Portal (Vets2PM® PMP® Boot Camp Plus Program page). Additionally, Vets2PM® facilitates provision of all learning content, live online classes, and online asynchronous content... with lifetime availability!

The following content is available on the Vets2PM® Student Portal:

1. Access to all upcoming Vets2PM®, Live-Webinar PMP®/ CAPM® Boot Camp courses
2. Access to all online PMP®/ CAPM® Boot Camp course review content
3. Digital Student Guide
4. Exam preparation materials (sample test questions, sample documents, etc.)

Additional content is available from *PMI®* and will be presented during your PMP® training.

Course Resources

www.pmi.org

- Create account
- Initiate PMP application

www.vets2pm.com

- Account created
- Student Portal
 - How to Complete Your PMP® Application in Under 60 Minutes
 - Vets2PM® PMP® Boot Camp Plus Program
 - PMI Resource Locker

www.pmi.lochoice.com

- Use pmi.org login username/password
- “Add Course”
- Input PMI Access Code (reference past email from Vets2PM®)
 - Also Instructor-provided

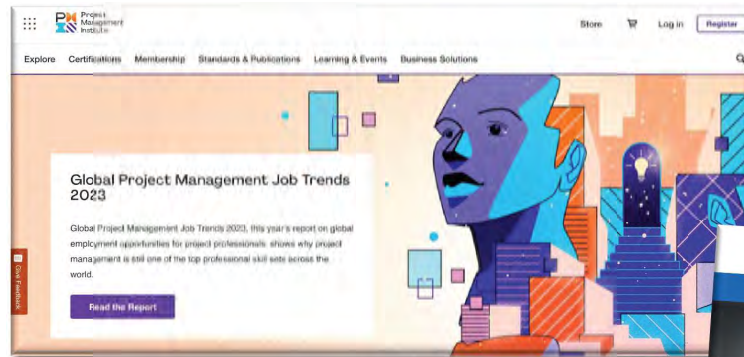

Thank you for joining
the Vets2PM Team!

Enjoy the Process!





PMI® AUTHORIZED PMP® EXAM PREP COURSE

Version 3.2 | 2023 Release



©2023 Project Management Institute, Inc. All rights reserved.
This material is being provided as part of a PMI® course.

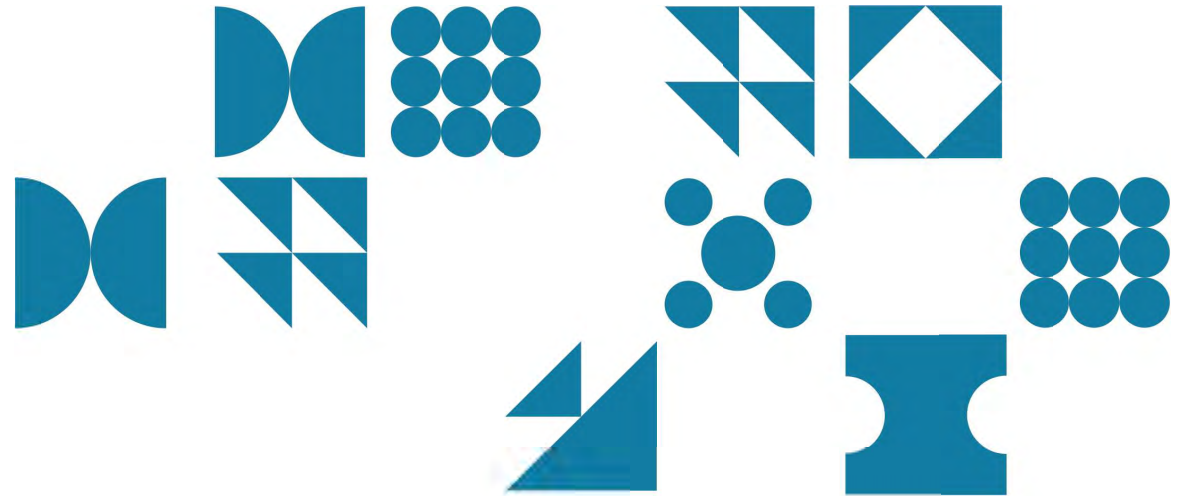

Welcome

Thank you for joining the PMI® Authorized PMP® Exam Prep course.

If you've earned your CAPM® certification with us, welcome back!

Or if you're coming from another project management background, certification or work experience, we are pleased to welcome you to PMI's community of learning.

We are proud of our 50-year history of peer-to-peer learning and membership and wish you the best of luck as you undertake your PMP® exam preparations.

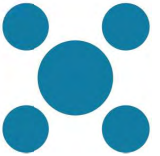

You, Getting Certified



- Four-year degree
- 36 months leading projects
- 35 hours of project management education/training or CAPM® certification

— OR —

- A high school diploma or an associate's degree (or global equivalent)
- 60 months leading projects
- 35 hours of project management education/training or CAPM® certification

You, Staying Certified



Spotlight Series

Welcome to the Project Management Institute's Spotlight series.

The Project Economy

The Project Economy backs the most important work all over the world.

No matter where you are, learning our core principles means you have a guided, lifetime practice in project management.

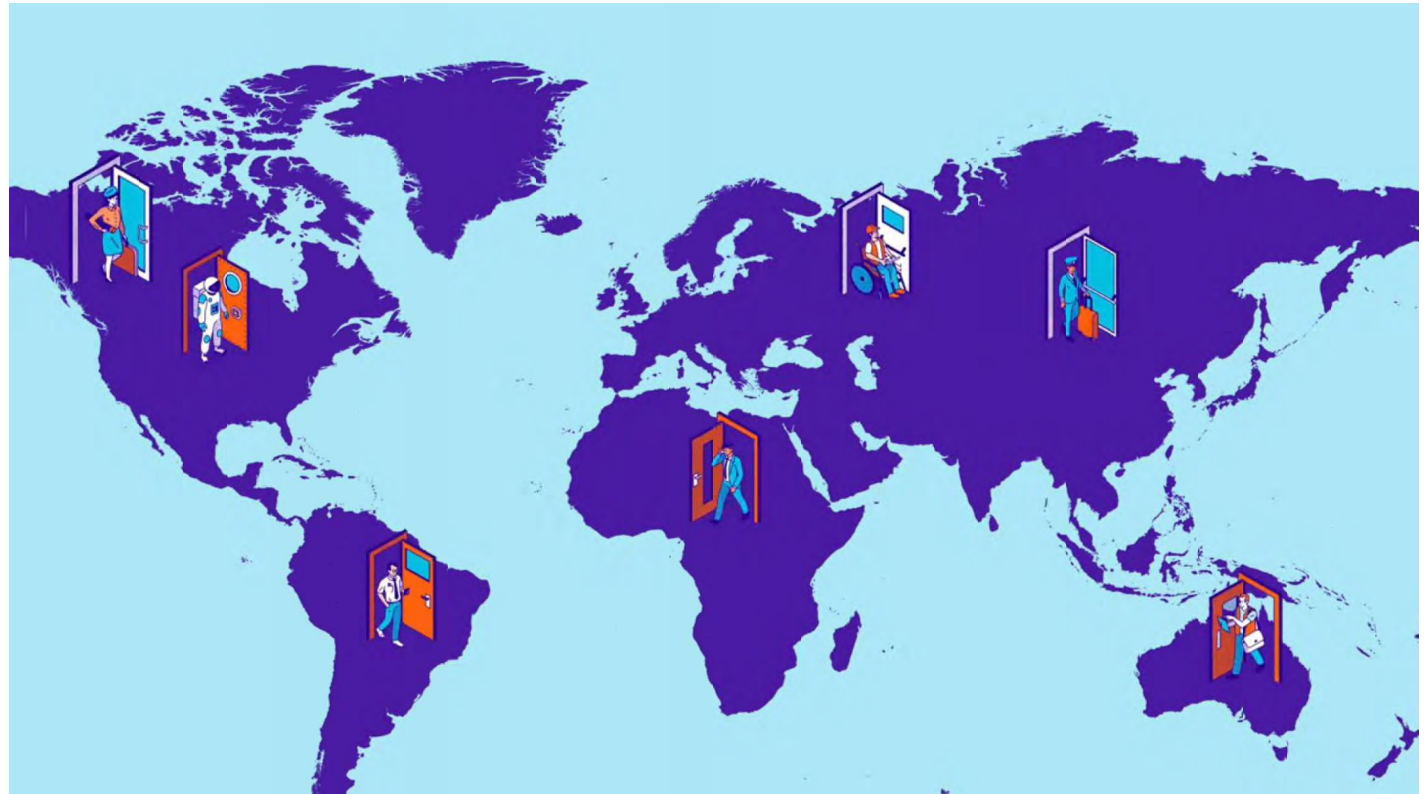

The PMP® Certification Exam

The PMP® exam includes content that spans the value delivery spectrum, including **predictive**, **adaptive** and **hybrid** approaches. It was updated in 2021 to reflect the fuller complement of skills and approaches found in our dynamic and global profession.

Just like the sides of the PMI Talent Triangle®, we focus on three performance domains in project management:

People | Power Skills – 42%

Process | Ways of Working – 50%

Business Environment | Business Acumen – 8%

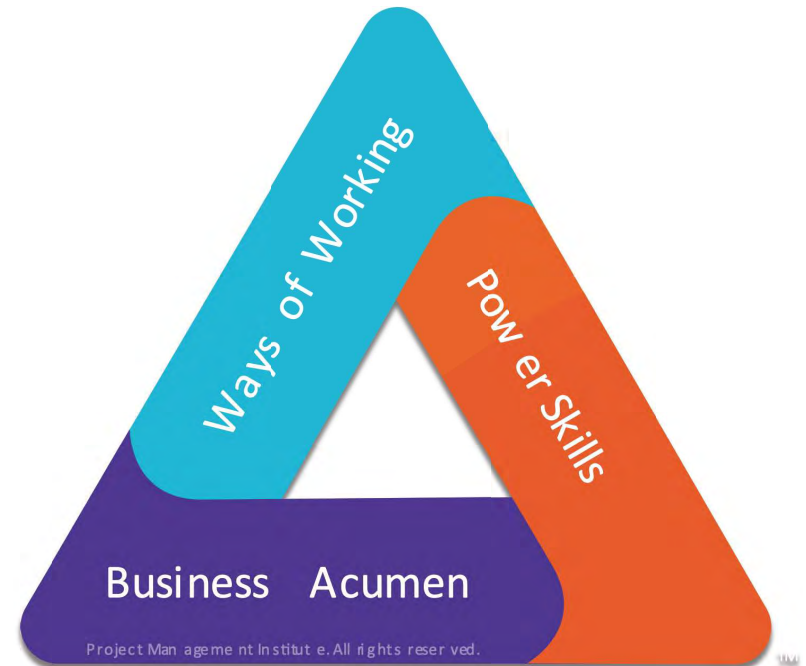

Learning Topics



The learning topics in this training come directly from the PMP® exam content outline (ECO). The ECO is the basis for the PMP® exam.

The relevant ECO content appears at the end of each topic, for your reference.

The ECO was created by a global selection of PMI members who hold the PMP® certification and work in diverse industries. It includes what they think you need to know to do the job, including experience and broader business concepts.

The PMP® Exam Format

- 180 questions
- 230 minutes to complete the exam
- Two optional 10-minute breaks for computer-based (online-proctored) tests, including center-based tests; paper-based exams have no breaks
- Questions are multiple-choice, multiple response, matching, hotspot and fill-in-the-blank

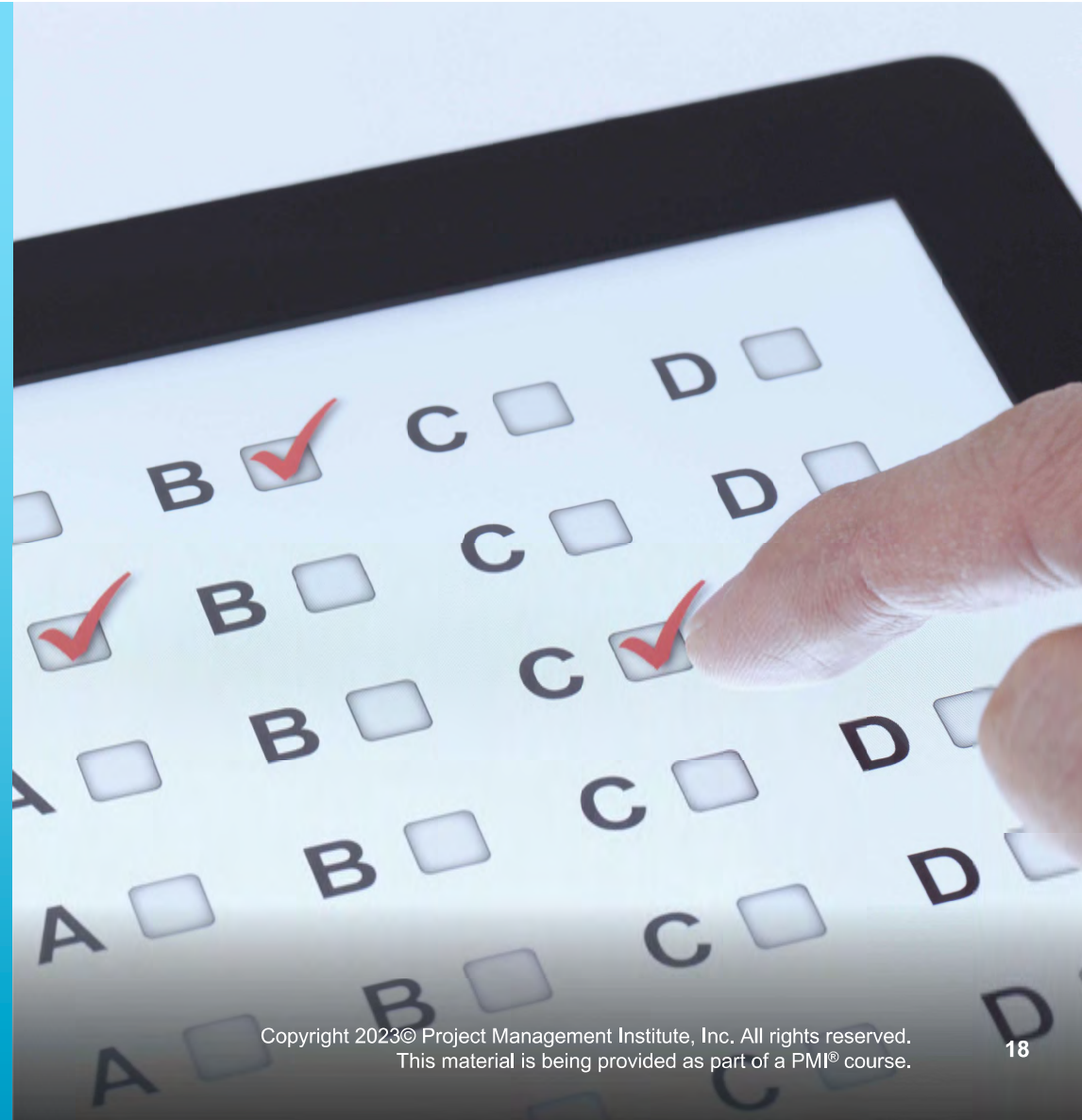

Preparing for the PMP Exam



Preparing for the PMP Exam

Spotlight Series

This presentation beams a spotlight on
Preparing for the PMP Exam!

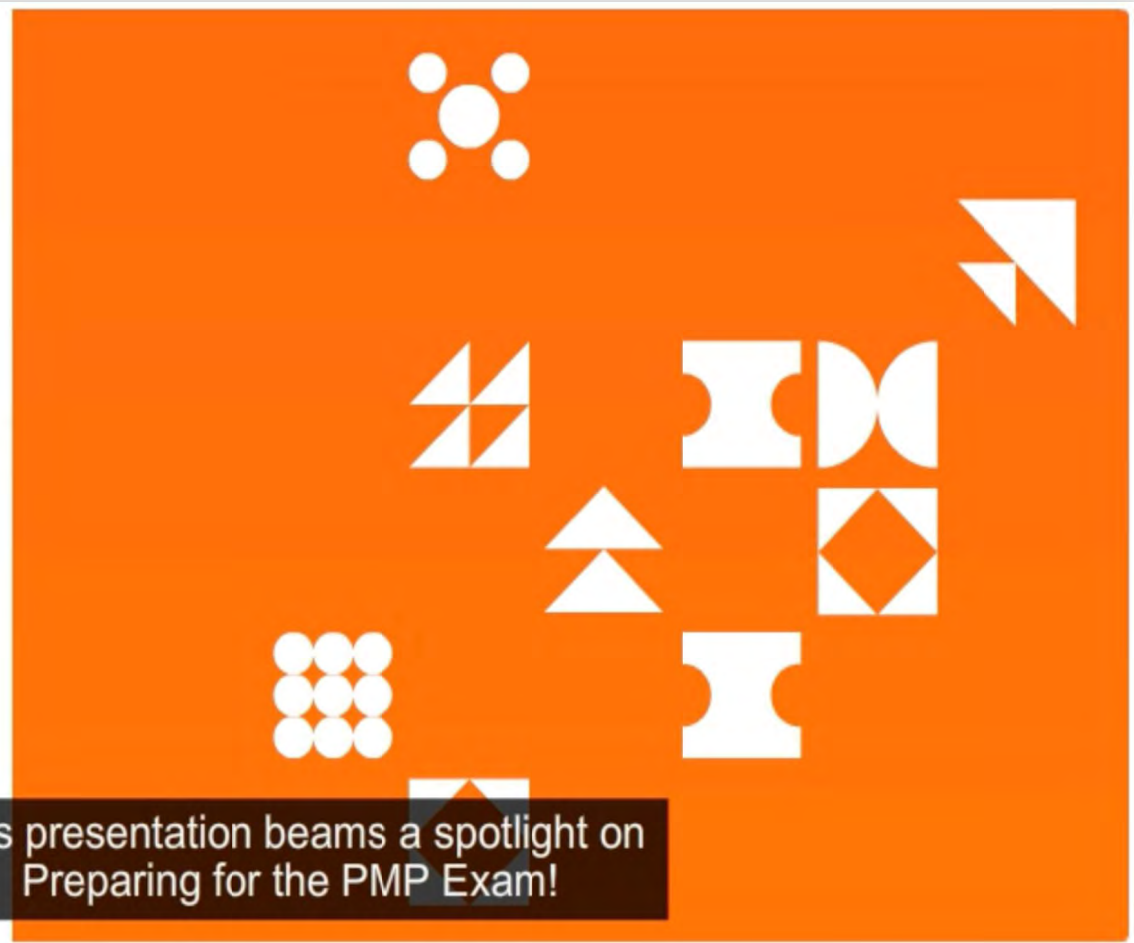

Contents

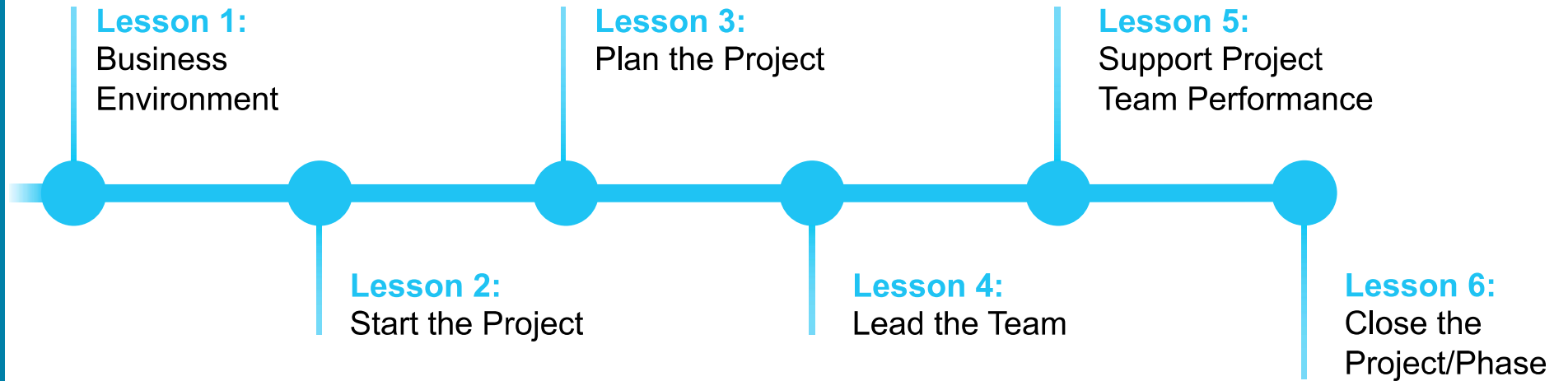

About This Course

Life cycle icons: To help highlight and differentiate concepts typical or unique to a certain life cycle, we use the corresponding icon:



Predictive



Adaptive



Hybrid

Other icons



Important



Interactive



Use Expert Judgment



Tools / Techniques



Question



Discussion



Note

Project management terminology: A course glossary is included as a PDF file. Your instructor may show definitions from the glossary on slides during the course.

*Example: **Project Management** | Defined words are **colored** or an asterisk (*) is placed next to them.*

Definition Slider

s Course

: To help highlight concepts typical or in life cycle, we use icon:



Predictive



Adaptive



Hybrid



Important



Interactive



Use Expert Judgment



Tools / Techniques



Question



Discussion



Note

Project Management terminology: A course glossary is included as a PDF file. You will see definitions from the glossary on slides during the course.

Project Management | *Defined words are colored or an asterisk (*) is placed*

PROJECT MANAGEMENT

The application of knowledge, skills, tools, and techniques to project activities to fulfill the project plan.

Project Case Study: Student Resource

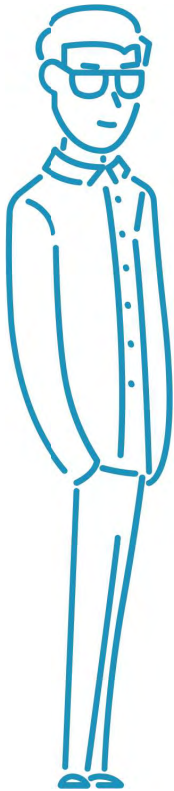

SHAWPE —INDUSTRIES—

Meet our **project manager, Ang Fen** and interact with him, the project team and stakeholders!

This is an immersive, fictional scenario of a hybrid project which includes review and reinforcement of project management concepts and practice exam questions.

Shawpe Lifestyle Centre (SLC) Project



The project team will develop and build a “lifestyle centre” in the historic Oasestown district, including design and occupancy of retail and community spaces

- Funding partner: Oasestown Municipality
- Development partner: Oases Architects
- US \$7 million initial capital budget
- 36-month timeline



Project Life Cycle Check-In

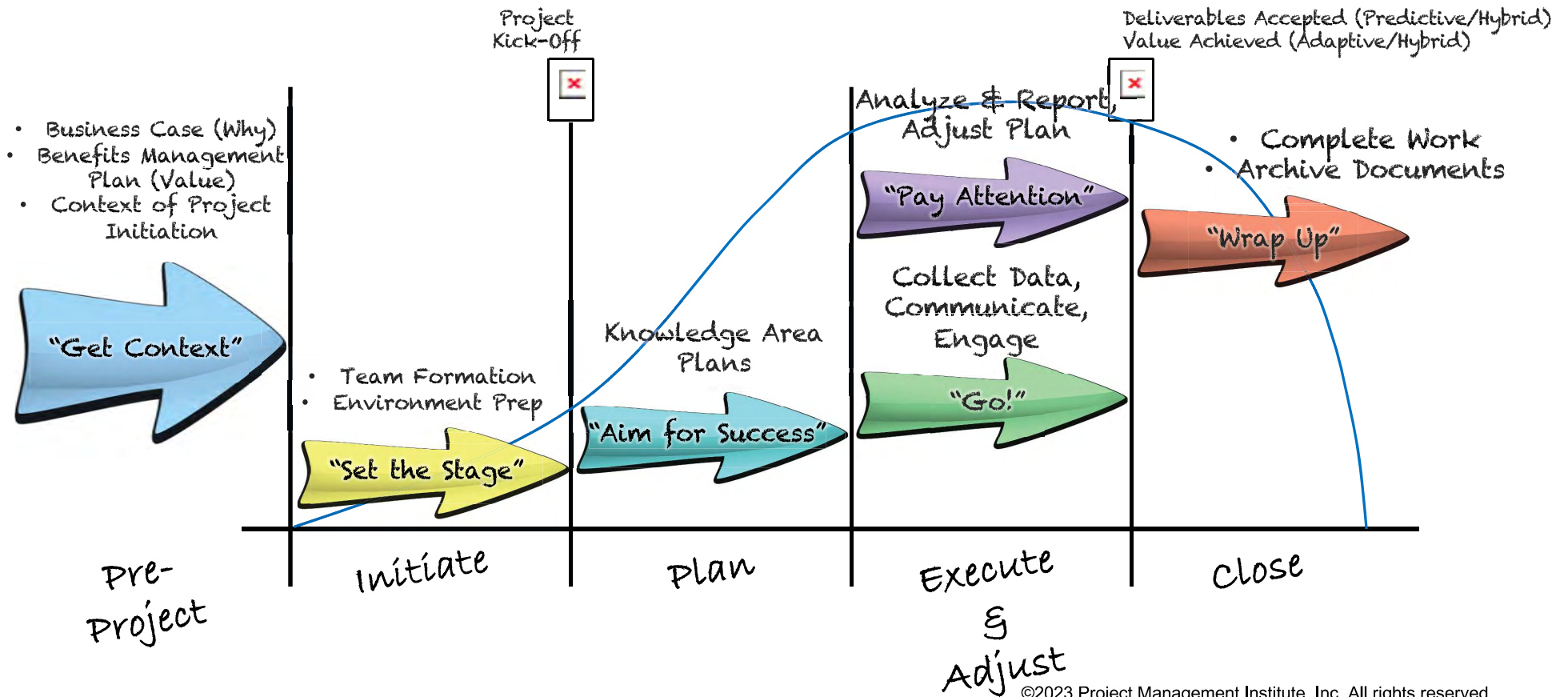

Let's Get to Work!

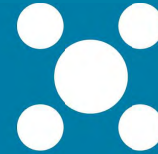

LESSON 1

BUSINESS ENVIRONMENT

- Foundation
- Strategic Alignment
- Project Benefits and Value
- Organizational Culture and Change Management
- Project Governance
- Project Compliance



Learning Objectives

- Define 'project' and how it relates to the larger discussion of project management.
 - Discuss the different types of organizational structures and how they relate to your project's management.
 - Discuss the principles of project management.
 - Discuss the principles of agile and how they relate to your project's management.
- Discuss strategic alignment and its elements.
 - Explain the impact of business factors on strategic alignment.
 - Determine how projects align with business strategy.
- Identify types of business value.
- Describe change management theory and its relation to organizational change.
- Define and discuss project governance.
- Explain project compliance and its importance.

Project Life Cycle Check-In

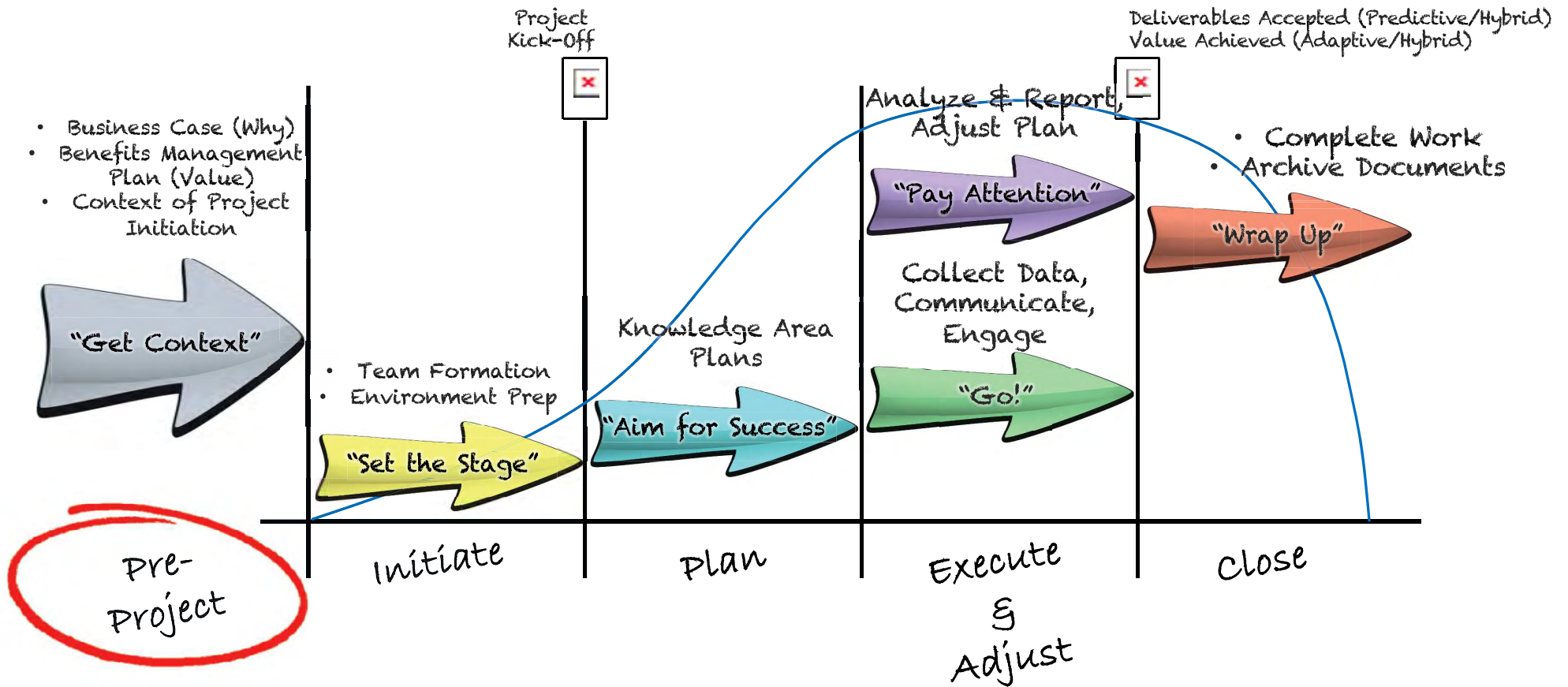



Foundation

TOPIC A

Project

A project:

- Creates a unique product, service or result
- Is time-limited
- Drives change
- Enables value creation for a business or organization

Project success depends on:

- Organizational project maturity
- Project manager effectiveness
- Funding and resource availability
- Team member skill levels
- Collaboration and communication within the team and with key stakeholders
- Understanding of the core problem and related needs

The Evolution of Project Management



Can you describe, in your own words, how project management has changed during this time?



ca. 1969 – PMI founded



The application of knowledge, skills, tools and techniques to project activities to meet the project requirements

2022 - Toward a systems view

“Projects do not simply produce outputs, but more importantly, enable those outputs to drive **outcomes** that ultimately deliver value to the organization and its stakeholders.”

- *PMBOK® Guide* - Seventh Edition

Project Management Life Cycles and Development Approaches

	Description	Key Roles	Value Delivery Proposition
	<p>Plan-based approach:</p> <ul style="list-style-type: none"> Activities completed in a distinct or linear fashion New phase begins only when the previous phase is completed 	<ul style="list-style-type: none"> Project sponsor authorizes project Team led by project manager 	<ul style="list-style-type: none"> Deliverables transitioned to customer at completion Value realized in both short and long term
	<p>Change-based approach:</p> <ul style="list-style-type: none"> Agile, incremental or iterative development Timeboxed cadence (iterations/sprints) or continuous flow 	<ul style="list-style-type: none"> Product owner controls value proposition Project team delivers work Process roles include team lead, scrum master, agile coach, facilitator 	<ul style="list-style-type: none"> Iterative or incremental delivery to customer during life cycle Regular customer feedback cycle enables continuous development of value toward a "final" product
	Any combination of the above		

Project Management Office (PMO)*



Many large and established project-oriented organizations have a PMO, but PMOs are not a requirement for project management practice.

PMOs can be:

Supportive

- Develop best practices, methodologies, standards and templates
- Coach, mentor, train, guide project managers

Controlling

- Monitor compliance with project management standards, policies, procedures and templates via project audits

Directive

- Manage shared resources
- Coordinate communication across projects

Agile Centers of Excellence (ACoEs) *aka Value Delivery Office (VDO)*

ACoEs enable, rather than manage, project efforts:

- Coach teams
- Build agile mindset, skills and capabilities throughout the organization
- Mentor sponsors and product owners

PROJECT MANAGEMENT OFFICE (PMO)

A management structure that standardizes the project-related governance processes and facilitates the sharing of resources, methodologies, tools and techniques. PMOs are more common in larger organizations because of the number of projects that can be in process at the same time.

PMOs can be:

Supportive

- Develop best practices, methodologies, standards and templates
- Coach, mentor, train, guide project managers

Controlling

- Monitor compliance with project management standards, policies, procedures and templates via project audits

Directive

- Manage shared resources
- Coordinate communication across projects

Agile Centers of Excellence (ACoEs) *aka Value Delivery Office (VDO)*

ACoEs enable, rather than manage, project efforts:

- Coach teams
- Build agile mindset, skills and capabilities throughout the organization
- Mentor sponsors and product owners

OPM: A System for Value Delivery

Organizational project management (OPM) – strategy execution framework that coordinates project, program, portfolio and operations management, and which enables organizations to deliver on strategy

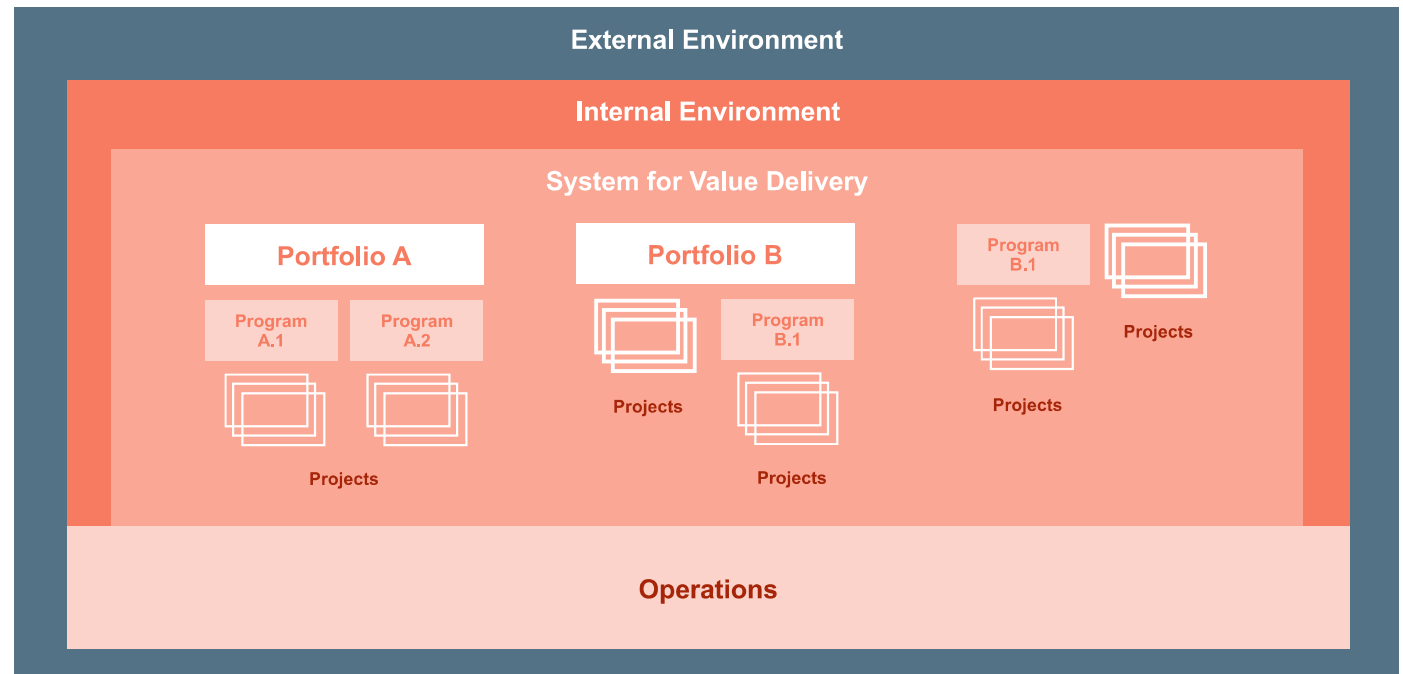

Projects, Programs, Portfolios

Portfolio Management	Collection of projects, programs, subsidiary portfolios and operations managed in a group to achieve strategic objectives	Aligns with business strategies
Program Management	Group of related projects, subsidiary programs and program activities managed in a coordinated manner to obtain benefits not available from managing them individually	Controls components and interdependencies to realize benefits
Project Management	Part of a broader program, portfolio or both	Enables achievement of organizational goals and objectives

Organizational Structures

- Functional
- Matrix
- Project-oriented
- Composite

Organizational structure and governance affects/determines:

- How organizational groups and individuals interrelate
- How much authority the project manager has
- What resources will be available
- How the project will be conducted

Relative Authority in Organizational Structures

	Functional	Matrix	Project-oriented
Team member loyalty	Functional department	Conflicted loyalty	Project
Team member reporting	Functional manager	Both functional manager and project manager	Project manager
Project manager role	Seldom identified	Coordinator to full project manager	Full-time and responsible
Team member role	Part-time on project	Part-time on project	Full-time on project (preferred)
Control of project manager over team members	Nonexistent (functional manager controls)	Medium – shared with functional manager/sponsor	High

Successful Persuasion



Successful Persuasion

Spotlight Series



This presentation will put a spotlight on Successful Persuasion!

Interactive/Activity



Think of your current or a recent project. Can you identify the organizational structure type and describe how it affects your project in the following ways?

- How organizational groups and individuals **interrelate**
- The project manager's authority
- **Resource** availability
- How the project is **conducted**



Project Management Principles

Guidance for All Project Practitioners

-
- a. Be a diligent, respectful and caring steward
 - b. Recognize, evaluate and respond to system interactions
 - c. Navigate complexity
 - d. Create a collaborative project team environment
 - e. Demonstrate leadership behaviors
 - f. Optimize risk responses
 - g. Effectively engage with stakeholders
 - h. Tailor based on context
 - i. Embrace adaptability and resiliency
 - j. Focus on value
 - k. Build quality into processes and deliverables
 - l. Enable change to achieve the envisioned future state

From Principles to Performance Domains

Use the 12 principles to guide behavior in the 8 project performance domains

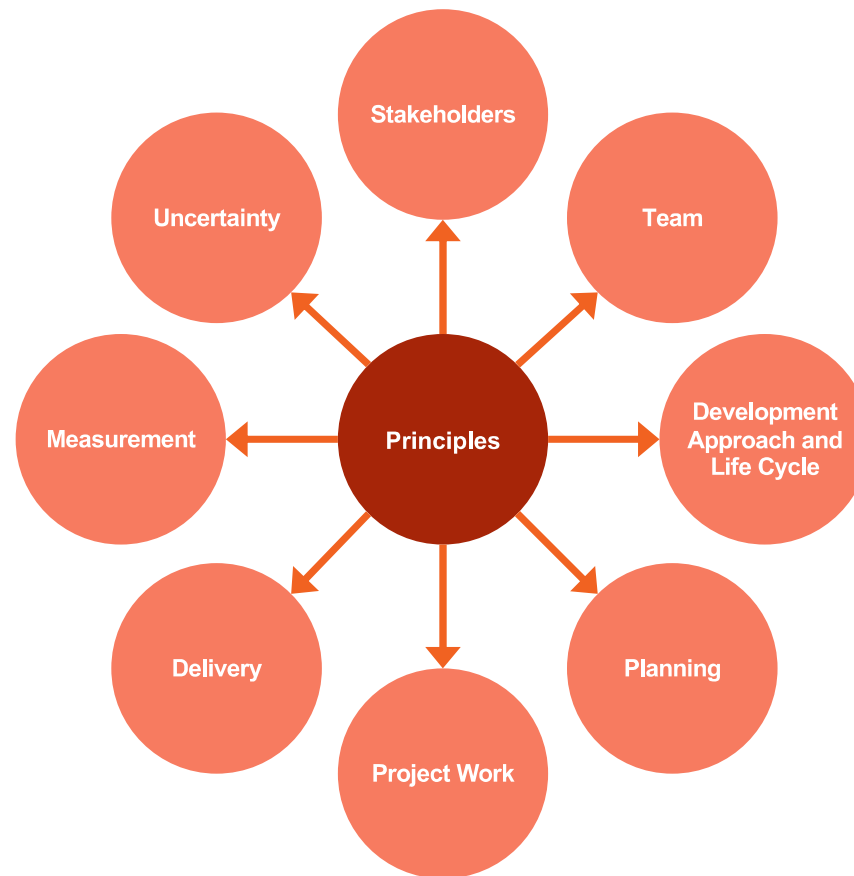

Agile

Derived from:

- Four values from the Agile Manifesto
- 12 principles



There are more than 50 known agile practices and methods in use!

The Agile Manifesto for Software Development

“We are uncovering better ways of developing software by doing it and helping others do it.

Through this work we have come to value:

Individuals and interaction	<i>over</i>	Process and tools
Working software	<i>over</i>	Comprehensive documentation
Customer collaboration	<i>over</i>	Contract negotiation
Responding to change	<i>over</i>	Following a plan

That is, while there is value in the items on the right, we value the items on the left more.”

-2001

Principles Behind the Agile Manifesto

1 to 6

-
1. Our highest priority is to satisfy the customer through early and continuous delivery of valuable software.
 2. Welcome changing requirements, even late in development. Agile processes harness change for the customer's competitive advantage.
 3. Deliver working software frequently, from a couple of weeks to a couple of months, with a preference to the shorter timescale.
 4. Businesspeople and developers must work together daily throughout the project.
 5. Build projects around motivated individuals. Give them the environment and support they need and trust them to get the job done.
 6. The most efficient and effective method of conveying information to and within a development team is face-to-face conversation.

Principles Behind the Agile Manifesto

7 to 12

-
7. Working software is the primary measure of progress.
 8. Agile processes promote sustainable development. The sponsors, developers, and users should be able to maintain a constant pace indefinitely.
 9. Continuous attention to technical excellence and good design enhances agility.
 10. Simplicity – the art of maximizing the amount of work not done – is essential.
 11. The best architectures, requirements, and designs emerge from self-organizing teams.
 12. At regular intervals, the team reflects on how to become more effective, then tunes and adjusts its behavior accordingly.

Agile:

The “Far Side” of Adaptive Approaches



“Doing Agile vs. Being Agile”

Agile means:

- Iterations are likely to be shorter
- Product is more likely to evolve based on stakeholder feedback

Still used for software development, and agile principles have been applied to other kinds of development projects, vis-à-vis *the agile mindset*.

- Adopt a flexible, change-friendly way of thinking and behaving
- Understand the purpose of these practices
- Select and implement appropriate practices based on context
- Internalize agile values, mindset and behavior

Tailor* Projects to Contexts

Because each project is unique, we adapt methods to the unique project context to determine the most appropriate ways of working to produce the desired outcomes.



Tailor iteratively and continuously throughout the project



TAILORING

Tailoring is the deliberate adaptation of the project management approach, governance, and processes to make them more suitable for the given environment and the work at hand.

Because each project is unique, we adapt methods to the unique project context to determine the most appropriate ways of working to produce the desired outcomes.



Tailor iteratively and continuously throughout the project

Tailor Hybrid Approaches, Processes, Practices and Methods



Apply product knowledge, delivery cadence and awareness of the available options to select the most **appropriate development approach**

Tailor **processes** for the selected life cycle and development approach; include determining which portions or elements should be added, modified, removed, blended, and/or aligned

Tailor **practices and methods** to the environment and culture

Topics Covered

- Foundational project management concepts
- Project management principles
- The Agile mindset
- Tailoring – hybrid approaches, processes and practices in project management

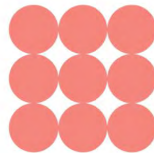
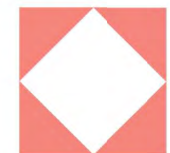
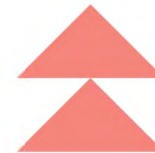
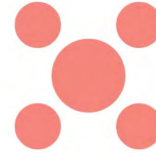



Strategic Alignment

TOPIC B

PMI Talent Triangle®

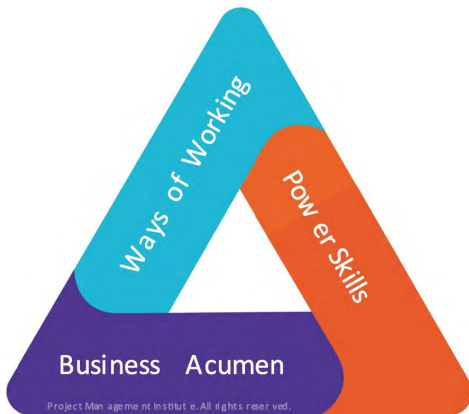

The PMI Talent Triangle® reflects the skills needed by today's project professionals and changemakers as they navigate the evolving world of project management.

Ways of Working

Mastering diverse and creative ways (predictive, adaptive, design thinking) to get any job done

Power Skills

The critical interpersonal skills required to apply influence, inspire change and build relationships

Business Acumen

Effective decision-making and understanding of how projects align with the big picture of broader organizational strategy and global trends

Strategic Alignment and Business Management Skills

Do you:

- Know your organization's **strategic plan**?
- Understand how project goals matter to an organization's long-term vision and mission?
- See a high-level overview of the organization?
- Have a working knowledge of business functions?
- Have pertinent product and industry expertise?

Can you:

- Explain the essential business aspects of a project?
- Work with SMEs and a sponsor to develop an appropriate project delivery strategy?
- Implement strategy to maximize the business value of project?



STRATEGIC PLAN

A high-level business document that explains an organization's vision and mission plus the approach that will be adopted to achieve this mission and vision, including the specific goals and objectives to be achieved during the period covered by the document.

Do you:

- Know your organization's **strategic plan**?
- Understand how project goals matter to an organization's long-term vision and mission?
- See a high-level overview of the organization?
- Have a working knowledge of business functions?
- Have pertinent product and industry expertise?

Can you:

- Explain the essential business aspects of a project?
- Work with SMEs and a sponsor to develop an appropriate project delivery strategy?
- Implement strategy to maximize the business value of project?

Strategic Management Elements and Frameworks



Note: From PMI's *Standard for Portfolio Management*

Some agile projects use a goal-setting framework such as OKRs (Objectives and Key Results) that describes the organization's objectives and desired key results.

Organizational Influences

Enterprise Environmental Factors (EEFs)

- Internal and external to the organization

Organizational Process Assets (OPAs)

- Project policies, procedures and templates
- Historical project information

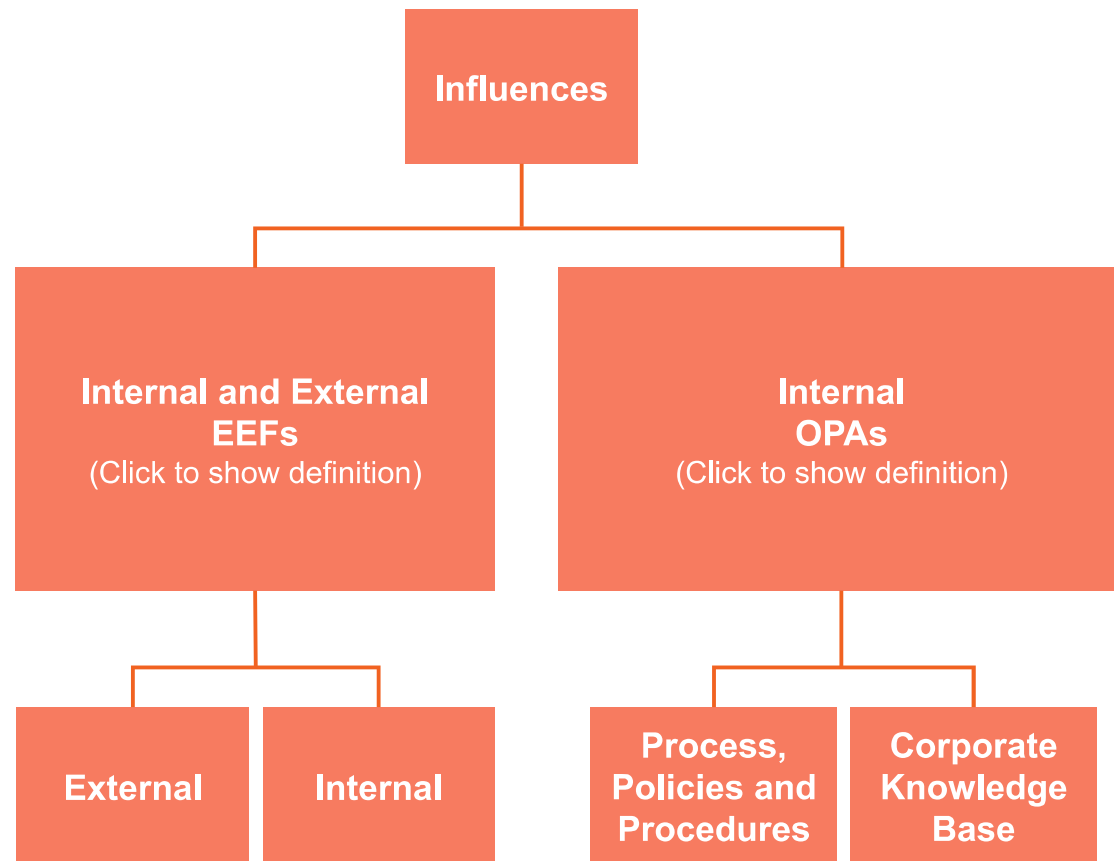

Get to Know the External Business Environment



Use frameworks or prompts to understand external factors that can introduce risk, uncertainty, or provide opportunities and affect the value and desired outcomes of a project:

- **PESTLE:** Political, economic, socio-cultural, technical, legal, environmental
- **TECOP:** Technical, environmental, commercial, operational, political
- **VUCA:** Volatility, uncertainty, complexity, ambiguity

In addition, review:

- Comparative advantage analysis
- Feasibility studies
- SWOT (strengths, weaknesses, opportunities and threats) analysis
- Assumption analysis
- Historical information analysis
- Risk alignment with organizational strategy

Internal Business Environment Factors

- **Organizational changes** can dramatically impact **scope**
- The **project manager, project sponsor** or **product owner** need to be familiar with business plans, reorganizations, process changes and other internal activities
- Internal business changes might cause:
 - Need for new deliverables
 - Reprioritization of value, including removal of existing deliverables



OPAs and EEFs

OPAs

Processes, policies and procedures

Examples—

- Organizational charts
- Procurement rules
- Hiring and onboarding procedures

Organizational knowledge bases

Examples—

- Engineering wikis
- Libraries or archives
- Lessons learned repositories

EEFs

Internal

Examples—

- Resource capabilities
- Organizational culture
- IT software
- Distribution of facilities

External

Examples—

- Marketplace conditions
- Laws, regulations and standards
- Operating conditions
- Social and cultural influences

Activity:

Identify OPAs and EEFs



Project name: Shawpe Lifestyle Centre

List of EEFs and OPAs:

- a. Economic demand for a new shopping area
- b. Historical society (conservation) building regulations
- c. Local neighborhood demand for a better town center
- d. Archive of past large infrastructure projects
- e. Approved vendor and contractors list
- f. Tenant selection process



Which are EEFs? Which are OPAs?

Topics Covered

- Define strategic alignment and business acumen
- Follow guidelines for effective business decision-making
- Explore organizational influences on projects
- Explain how projects align with broader organizational strategy and global trends

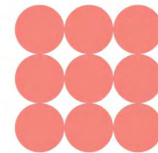
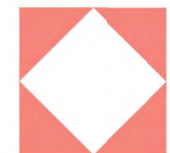
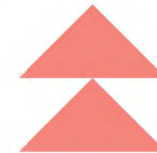
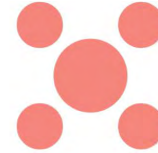



Project Benefits and Value

TOPIC C

Business Value

- The net quantifiable benefit (tangible and/or intangible) identified from a business endeavor
- Part of the objectives or description of the project in the initiating agreements
- Benefits realization is based on declared business value



Examine Business Value

-
- Communicate with stakeholders, do the research and use expert knowledge
 - Examine, evaluate and confirm to determine exactly what is *or can be* of value!

Look especially at:

- Shareholder value (publicly traded companies) or business growth (private)
- Customer value
- Employee knowledge
- Channel or business partner value

Types of Business Value



**Financial
Gain**



**New
Customers**



**Social
Benefit**



**First to
Market**



Improvement
*Technological,
process, etc.*



Regularization
*Alignment or
compliance with
standards and
regulations*

Needs Assessment

Obtain Data for the Project

Note: From *Business Analysis for Practitioners: A Practice Guide*

-
- Usually performed by a **business analyst**
 - Precedes the business case
 - Involves understanding of:
 - Business goals and objectives
 - Issues and opportunities
 - Recommends proposals to address:
 - What should be done
 - Constraints, assumptions, risks and dependencies
 - Success measures
 - Implementation approach

Business Documents

-
- Are developed prior to project start (usually by a business analyst or key project stakeholder)
 - Contain information about the project's objectives and contribution to the business goals
 - Help the business to determine whether a project is worth the required investment of time, money, and resources



Review the business documents periodically

Business Documents

Business Case and Benefits Management Plan



Business case: justifies project and establishes boundaries

- Cost-benefit analysis
- Business need
- Quality specifications
- Schedule or cost constraints



Acceptance of the business case usually leads to creation of the project charter.

Benefits management plan should include:

- Processes for creating, maximizing and sustaining project benefits
- Time frame for short- and long-term benefits realization
- Benefits owner or accountable person
- Metrics
- Assumptions, constraints and risks



This is a business document, not part of the project management plan.

©2023 Project Management Institute, Inc. All rights reserved.
This material is being provided as part of a PMI® course.

BENEFITS MANAGEMENT PLAN

The documented explanation defining the processes for creating, maximizing, and sustaining the benefits provided by a project or program. It also describes how and when the benefits of a project will be derived and measured. Both the business case and the benefits management plan are developed with the benefits owner prior to the project being initiated. Additionally, both documents are referenced after the project has been completed. Therefore, they are considered business documents rather than project documents or components of the project management plan.

Business case: justifies project and establishes boundaries

- Cost-benefit analysis
- Business need
- Quality specifications
- Schedule or cost constraints



Acceptance of the business case usually leads to creation of the project charter.

Benefits management plan should include:

- Processes for creating, maximizing and sustaining project benefits
- Time frame for short- and long-term benefits realization
- Benefits owner or accountable person
- Metrics
- Assumptions, constraints and risks



This is a business document, not part of the project management plan.

Benefit Measurement Methods



Cost-benefit analysis: How businesses justify the selection (authorization) of a project

Business - “smaller is better”

- Estimate payback period — Smallest number (duration) chosen
- Assess **opportunity cost** — What if we didn’t undertake the project?

Financial - largest number (profit) chosen - “bigger is better”

- Time value of money
 - Present value (PV)
 - Future value (FV)
 - Net present value (NPV)
- **Internal rate of return (IRR)**
- **Return on investment (ROI)**



You will not need to calculate any of these for the exam.

COST-BENEFIT ANALYSIS

Is one method of measuring or evaluating a project's benefit and value.

OPPORTUNITY COST

A concept applied to quantify the missed opportunity when deciding to use a resource (e.g., investment dollars) for one purpose versus another. Alternately opportunity cost is the loss of potential future return from the second-best unselected project. In other words, it is the opportunity (potential return) that will not be realized when one project is selected over another.

INTERNAL RATE OF RETURN (IRR)

The interest rate that makes the net present value of all cash flow equal to zero. This rate is a function of the cost of capital for project implementation.

RETURN ON INVESTMENT (ROI)

A financial metric of profitability that measures the gain or loss from an investment relative to the amount of money invested.

analysis: How businesses justify the selection of a project

s better"

ack period — Smallest number (duration) chosen

portunity cost — What if we didn't undertake the project?

number (profit) chosen - "bigger is better"

of money

t value (PV)

value (FV)

sent value (NPV)

e of return (IRR)

nvestment (ROI)

eed to calculate any of these for the exam.

Project Selection Using Present Value (PV) and Net Present Value (NPV)

PV applies to projects that span several time periods when the value of money might change – e.g., inflation

Factors to determine PV include:

- Future value
- Interest rate
- Number of periods

Net present value (NPV):

- Is used for capital budgeting
- Accounts for inflation and macro-economic change (discount rate)
- Compares the value of a currency unit today to the value of the same currency unit in the future

Year	0	1	2	3	4
Net Cash Flows	-1200	+400	+800	+600	+1200
Factor	1	.91	.83	.75	.68
Net Present Value	-1200	+364	+664	+450	+816

How OKRs Help Deliver Business Value



-
- Start with organizational objectives
 - Decide key desired results
 - Refine further with objectives and key results (OKRs):
 - Objectives are goals and intents
 - Key results are time-bound and measurable milestones under these goals and intents

OKR best practices:

- Support each objective with between 3-5 measurable key results
- Aim for 70% success rate to encourage competitive goal-making. A 100% success rate should be re-evaluated as not challenging enough
- Write OKRs that are action-oriented and inspirational and include concrete, measurable outcomes

Incremental Value Delivery



An incremental development approach can:

- Enable value delivery sooner
- Attain higher customer value and increased market share
- Allow partial delivery (or previews) to customers
- Enable early feedback, allowing for adjustments to the direction, priorities and quality of the product

ECO Coverage

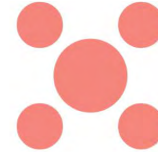

3.2 Evaluate and deliver project benefits and value

- Investigate that benefits are identified (3.2.1)
- Evaluate delivery options to deliver value (3.2.4)

2.1 Execute project with the urgency required to deliver business value

- Assess opportunities to deliver value incrementally (2.1.1)

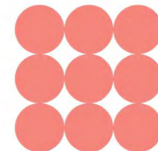
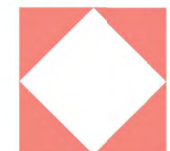
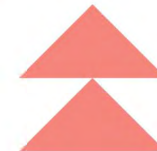



Organizational Culture and Change Management

TOPIC D

Change Management*

- Organizations embrace change as a strategy.
- PMOs build and sustain alignment between projects and the organization.
- Whether your organization has a PMO or not, you are a “changemaker”!
 - Tailor a strategy to circumstances, people and timing
 - Use a robust approach

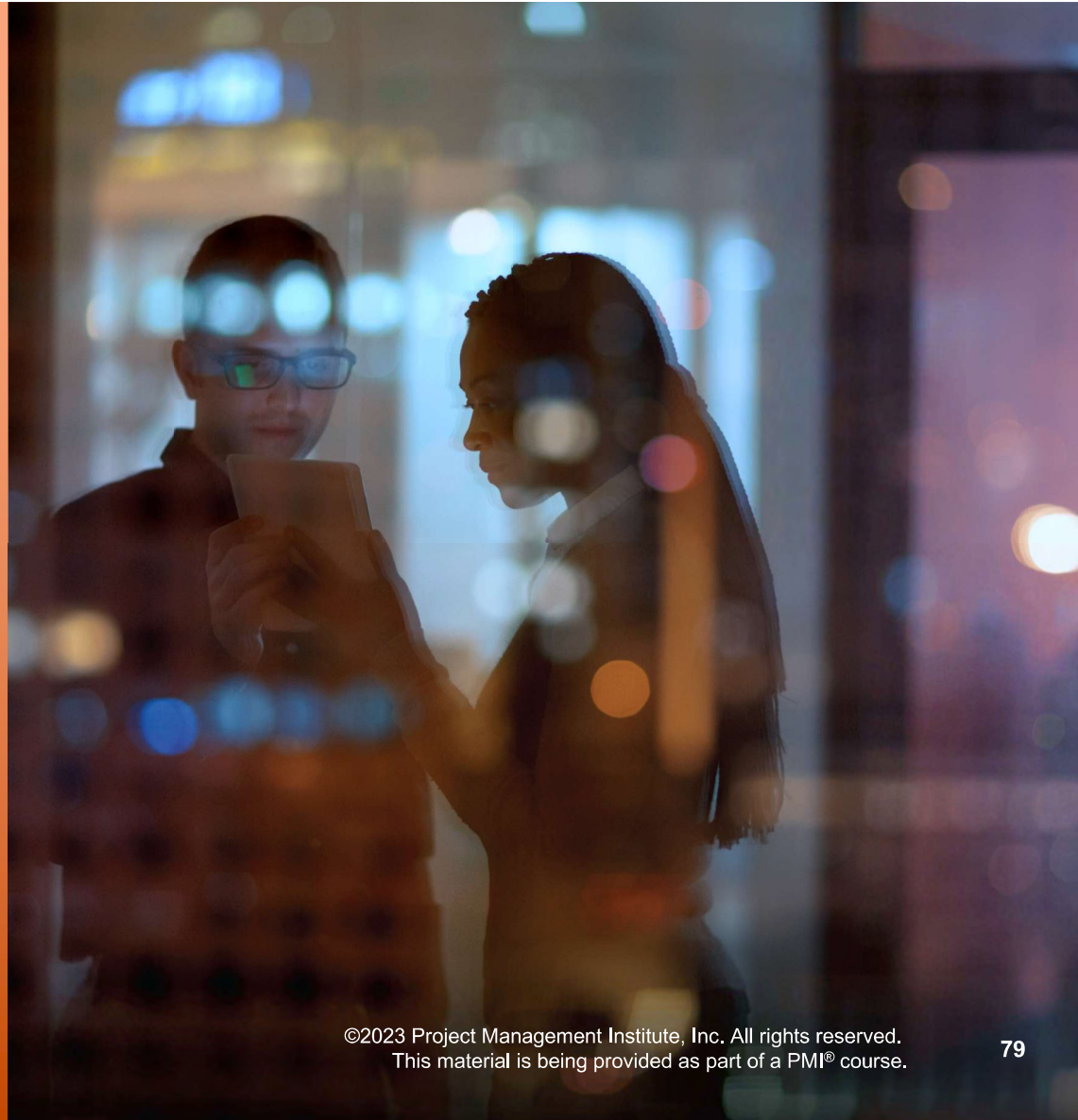

ment*

CHANGE MANAGEMENT

A comprehensive, cyclic, and structured approach for transitioning individuals, groups, and organizations from a current state to a future state in which they realize desired benefits. It is different from project change control, which is a process whereby modifications to documents, deliverables, or baselines associated with the project are identified and documented, and then are approved or rejected.

change as a
alignment
organization.
n has a PMO
maker”!
e and timing
ch

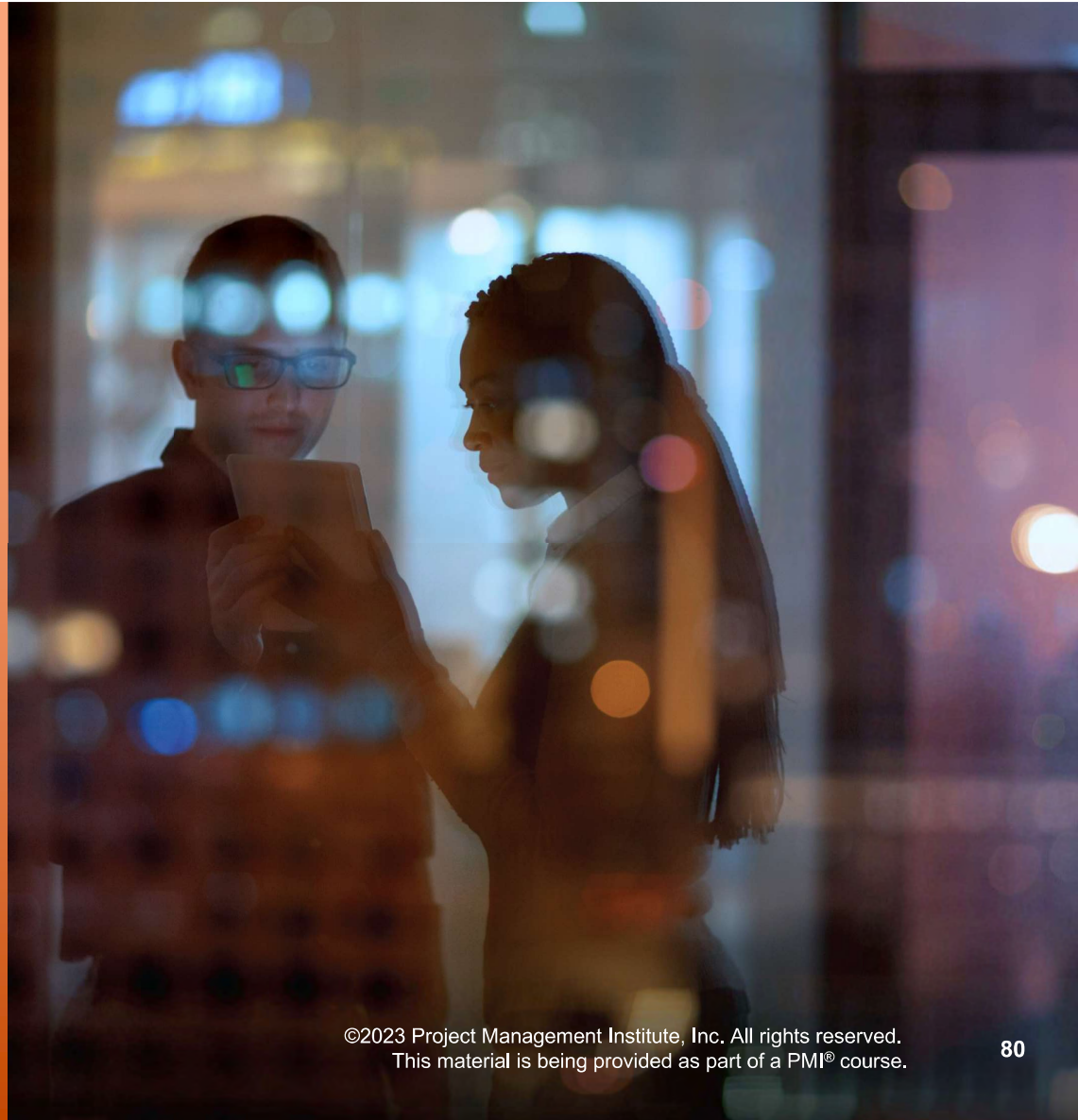

Manage Organizational Change Impacts on Projects



-
- **Assess** organizational culture
 - **Evaluate** impact of organizational change to project and determine required actions
 - **Recommend** options for changes to project
 - Continually **monitor** external business environment for impacts to project scope/backlog

Get to Know Organizational Cultures and Styles

- View of leadership, hierarchy and authority
- Shared vision, beliefs and expectations
- Diversity, equity and inclusion practices
- Risk tolerance
- Regulations, policies and procedures
- Code of conduct
- Operating environments
- Motivation and reward systems

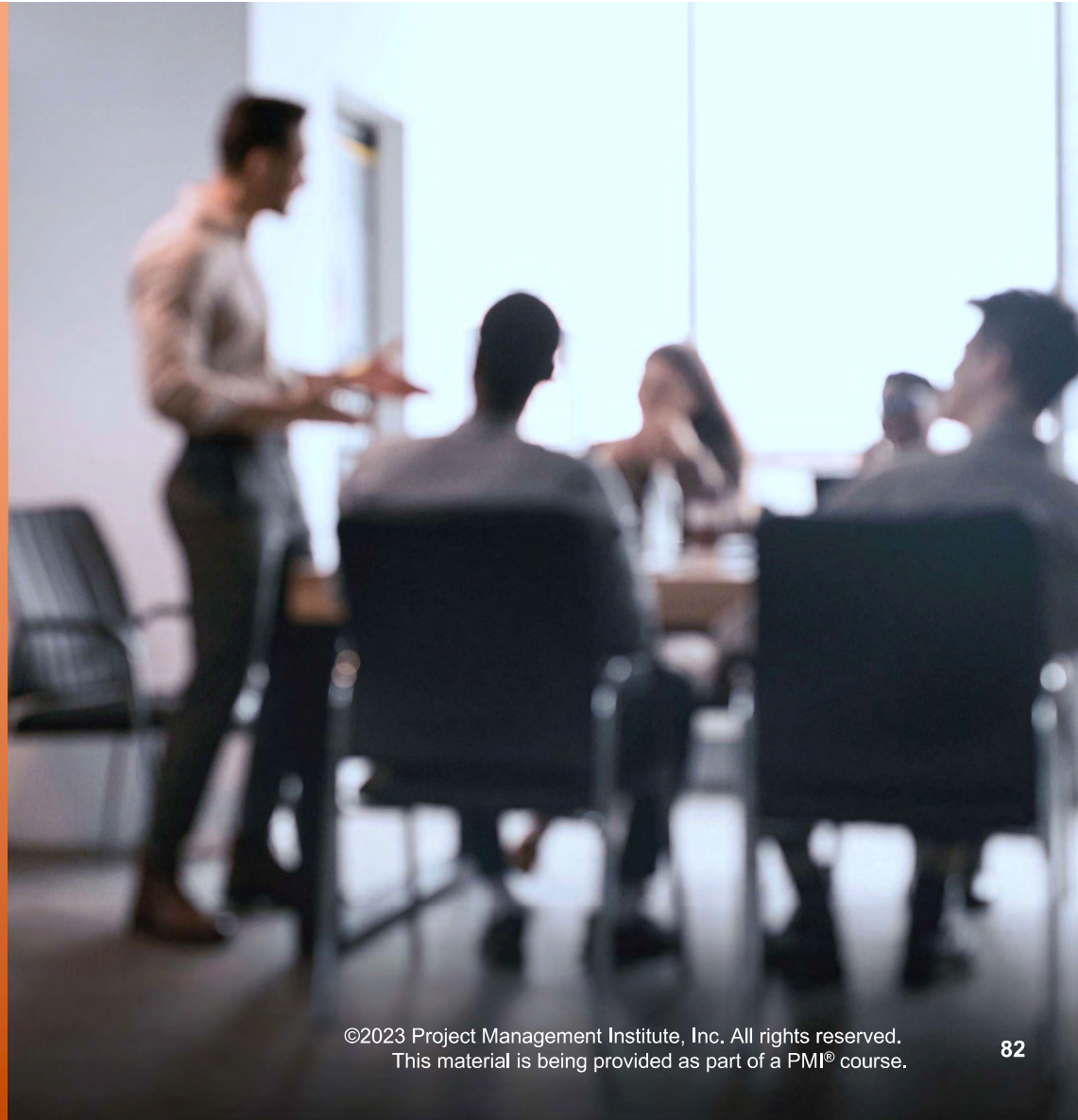

Risk, Culture and Change in Organizations



Risk threshold and appetite are shaped by diverse values of:

- Country/region
- Industry/sector
- Leadership
- Project team

These must be understood with care to:

- Establish effective approaches for initiating and planning projects
- Identify the accepted means for getting work done

Change Management Framework



“Organizational change requires individual change”

The **ADKAR**[®] model names five milestones an individual must achieve in order to change successfully:

- **A** – Awareness of the need for change
- **D** – Desire to support the change
- **K** – Knowledge of how to change
- **A** – Ability to demonstrate new skills and behaviors
- **R** – Reinforcement to make the change stick

Actions to Support Change



DO

- **Coach co-workers to support the business** — patience and compassionate mentoring are key
- **Enable an agile operating system** - Coach team members in agile to facilitate adoption of a change-centered mindset
- **Keep knowledge current** – Continuously improve processes and knowledge

DON'T

- **Force changes** – Involve and consult; aim to secure buy-in to the reasons for change
- **Alienate resisters** – Change can breed conflict, so proceed carefully

Plan for Change

Define the knowledge transfer, training and readiness activities required to implement the change brought by the project

- Include an **attitudinal survey** to find out how people are feeling
- Create an **informational campaign** to familiarize people with changes
- Be open and transparent about potential effects of the changes
- Consider creating a rollout plan



The rollout plan is not a project management plan component.

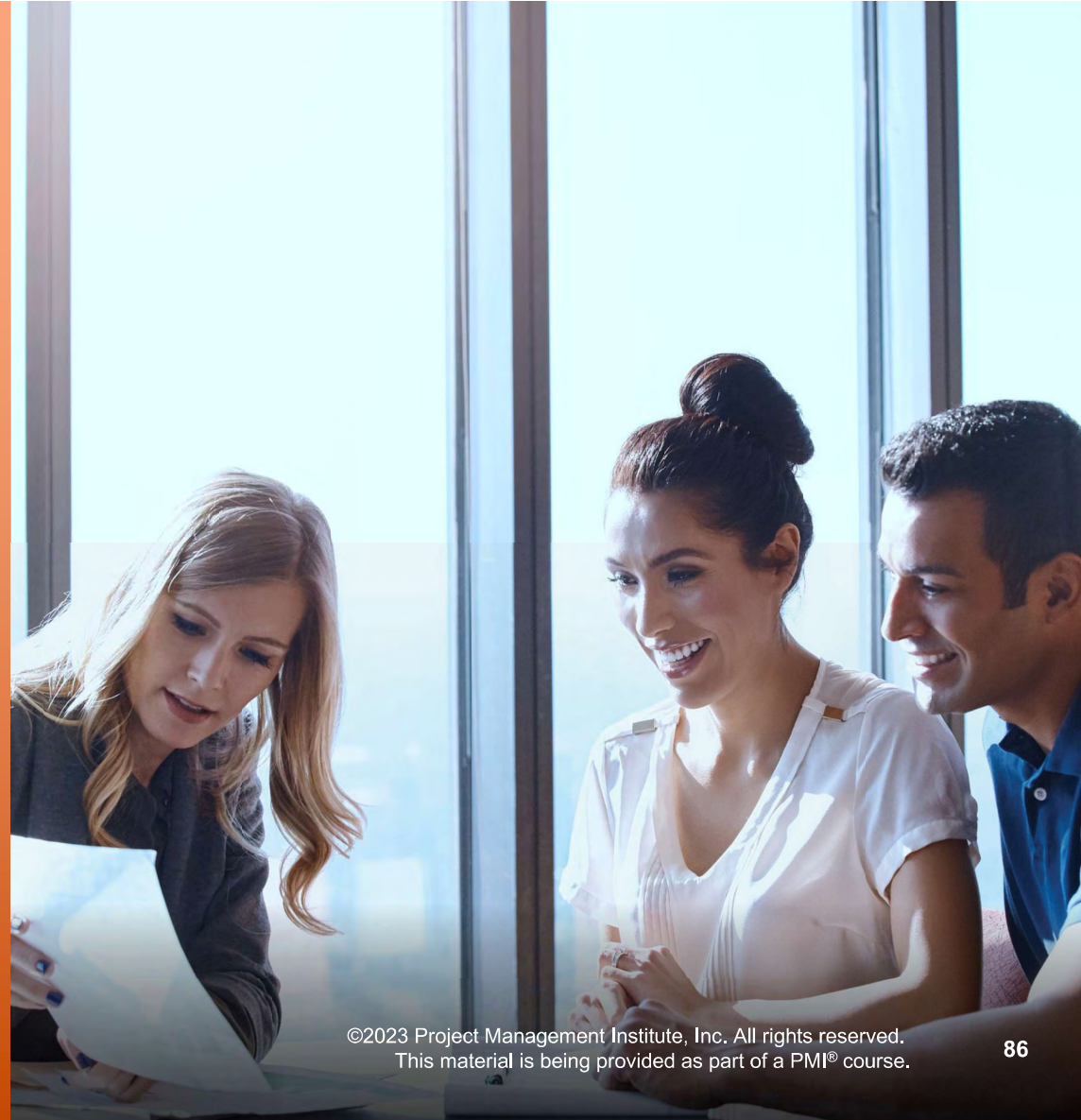

Organizational Transformation for Project Practitioners

- A **North Star statement** articulates the vision and strategic objectives
- **Customer insights** and **global megatrends**
- A flat, adaptable cross-functional **transformation operating system**
- Internal **volunteer champions** (not external consultants)
- **Inside-Out Employee Transformation** (similar to ADKAR)



Brightline® - a PMI initiative

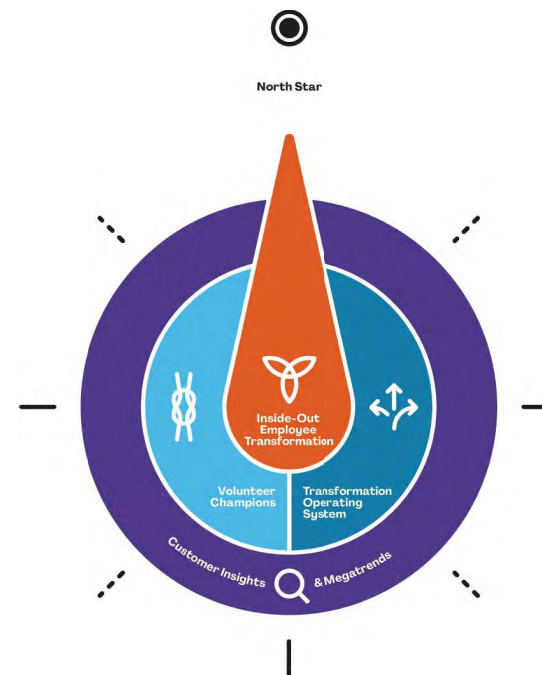

The Brightline^(R) Transformation Compass and five building blocks of transformation - an enterprise-level change management framework

ECO Coverage

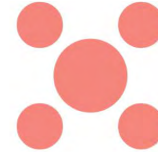

3.4 Support organizational change

- Assess organizational culture (3.4.1)
- Evaluate impact of organization change to project, and determine required actions (3.4.2)
- Evaluate impact of the project to the organization and determine required actions (3.4.3)

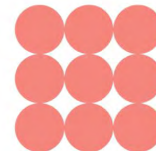
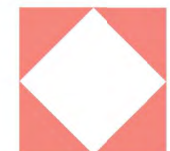
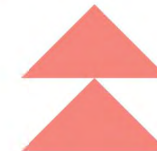



Project Governance

TOPIC E

Project Governance

The framework, functions, and processes that guide project management activities to create a unique product, service, or result to meet organizational, strategic, and operational goals.

Key benefits:

- Offers a single point of accountability
- Encompasses the **project life cycle**

Governance type differs among organizations and projects.

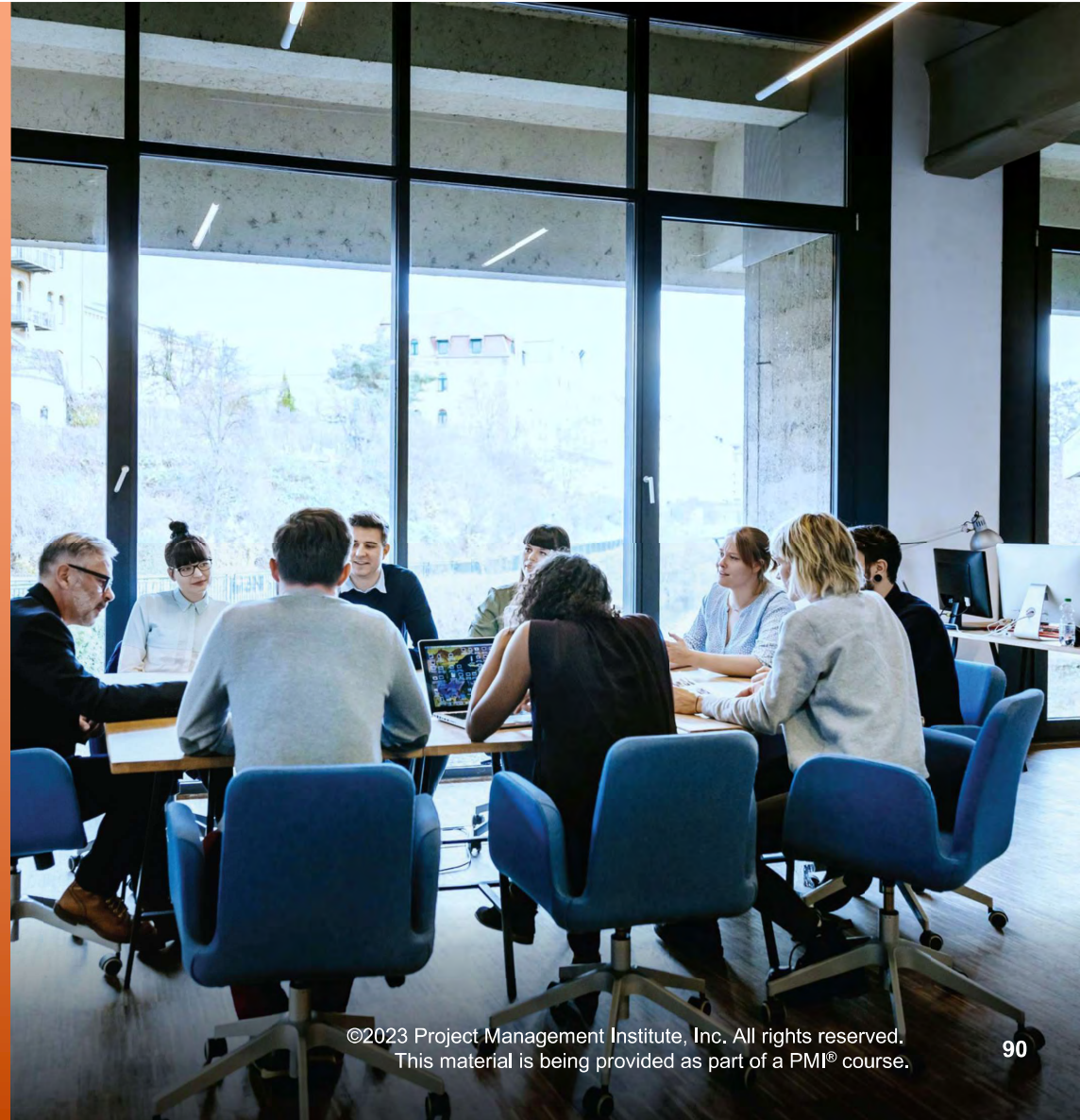

Project Governance

What Kind and How Much?



Too much governance can annoy stakeholders, while relaxed governance can lead to a lack of stakeholder engagement or accountability.

Governance:

- Is typically already in place – established by a PMO or aligned with organizational policies
- Depends on strategic importance of project, constraints or oversight requirements



- *Critical for managing internal or external business environment change and deviations in budget, scope, schedule, resources or quality*
- *Budget management oversight is a key governance area.*

Project Governance: Components

Processes for:

- Change
- Communication
- Documentation—e.g., project management plan
- Decision-making
- Internal stakeholder alignment with project process requirements
- Review and approval of changes above project manager authority level
- Risk and issue identification, escalation, and resolution
- Stage gate or phase reviews
- Guidelines for aligning project governance and organizational strategy
- Project life cycle and development approach
- Project organization chart with roles
- Project success and deliverable acceptance criteria
- Relationship among project team, organizational groups, and external stakeholders

Governance in Adaptive Projects



Can:

- Document outputs and expectations
- Provide a clear view of project status from:
 - Defined iteration/sprint expectations and outputs
 - Releases tied to specific dates
 - “Real-time” monitoring of project output through daily standups

Iterative approaches enable quicker and less costly identification of value-based outputs than predictive

Governance Board

aka Project Board
or Steering
Committee



*Does anyone have
experience with a project
governance board?
Describe how it works
with your project.*

-
- Provides project oversight
 - May include project sponsor, senior managers and PMO resources
 - May be responsible for:
 - Reviewing key deliverables
 - Providing guidance for project decisions



Projects that use Scrum or SAFe® use intermediary governance boards to liaise between the project and organizational governance

Governance Defines Escalation Procedures

For problems outside a project's **thresholds** or **tolerance** levels:

- **Escalate** to the responsible stakeholder who is authorized to take action;
- But if an issue is within the threshold, then work with the team to find a resolution.

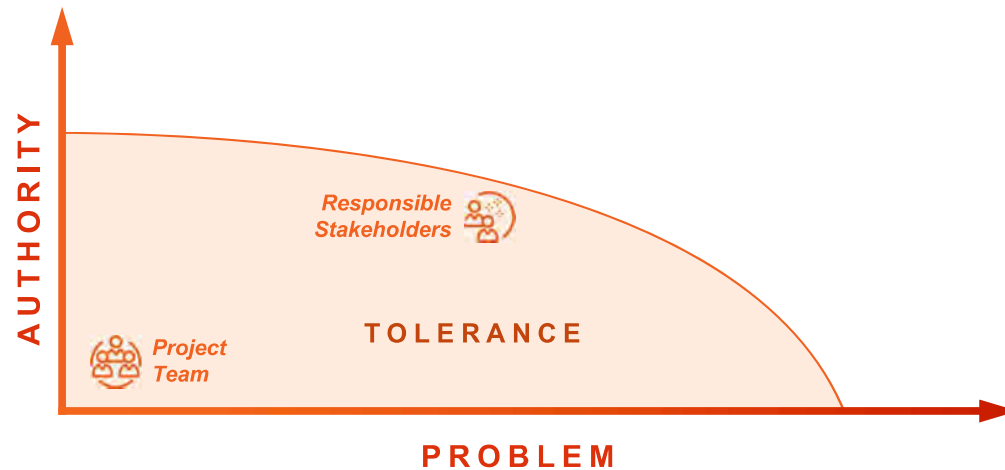

THRESHOLD

A predetermined value of a measurable project variable that represents a limit that requires action to be taken if it is reached.

TOLERANCE

The quantified description of acceptable variation for a quality, risk, budget, or other project requirement.

ESCALATE

The act of seeking helpful intervention in response to a threat that is outside the scope of the project or beyond the project manager's authority.

For problems outside a project's **thresholds** or **tolerance** levels:

- **Escalate** to the responsible stakeholder who is authorized to take action;
- But if an issue is within the threshold, then work with the team to find a resolution.

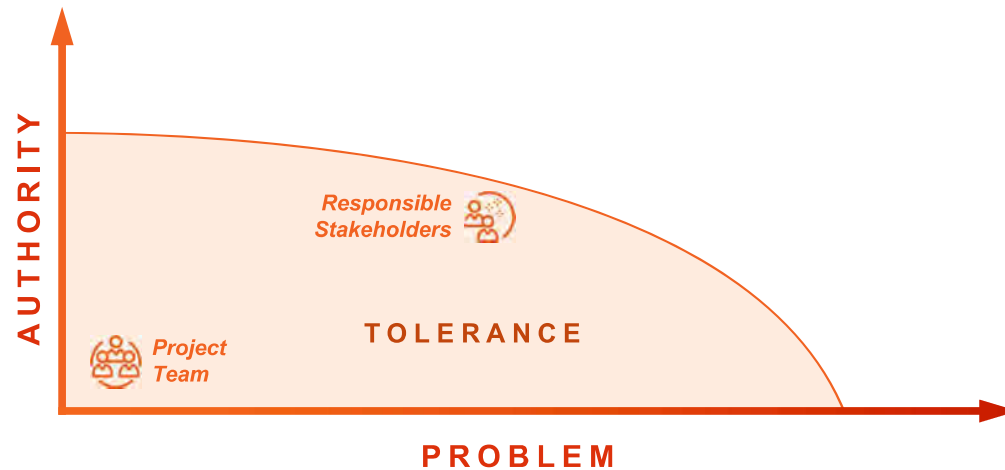

Governance and Life Cycles

A Systems View



*Remember the project management principle - **Recognize, evaluate and respond** to system interactions*



Governance system works alongside the value delivery system — the **project life cycle**.

Why? To enable smooth workflows, manage issues and support decision making.



Value delivery as
product of life cycle



Value delivery
embedded in life cycle

PROJECT LIFE CYCLE

The series of phases that a project passes through from its start to its completion.

Governance system works alongside the value delivery system — the **project life cycle**.

Why? To enable smooth workflows, manage issues and support decision making.



Value delivery as
product of life cycle



Value delivery
embedded in life cycle

Governance Checkpoints: Phase Gates and Iterations



Predictive



Adaptive

Split work into phases	Split work into releases
Review results at a phase gate – aka, governance gate, kill point, or tollgate	Review results at end of iterations
Decide: <ul style="list-style-type: none"> • Continue to the next phase • Continue with modifications, or • End a project or program 	Gather feedback and take action to improve value in next iteration
	Continue until customer’s acceptance criteria – e.g., definition of done or MVP – is satisfied or project ends



PHASE

Refers to a collection of activities within a project. Each project phase is goal oriented and ends at a milestone.

PHASE GATE

A point review at the end of a phase in which a decision is made to continue to the next phase, to continue with modification, or to end a project or program.

MINIMUM VIABLE PRODUCT (MVP)

The smallest collection of features that can be included in a product for customers to consider it functional. In Lean methodologies, it can be referred to as “bare bones” or “no frills” functionality.

Checkpoints: Phase Gates and Iterations

Predictive	 Adaptive
	Split work into releases
Phase gate – aka, governance	Review results at end of iterations
Next phase modifications, or program	Gather feedback and take action to improve value in next iteration
	Continue until customer’s acceptance criteria – e.g., definition of done or MVP – is satisfied or project ends

Project Phases Relationships



Phases produce one or more deliverables; outputs from one phase are generally inputs to the next phase.

They can have **sequential** or **overlapping relationships**.

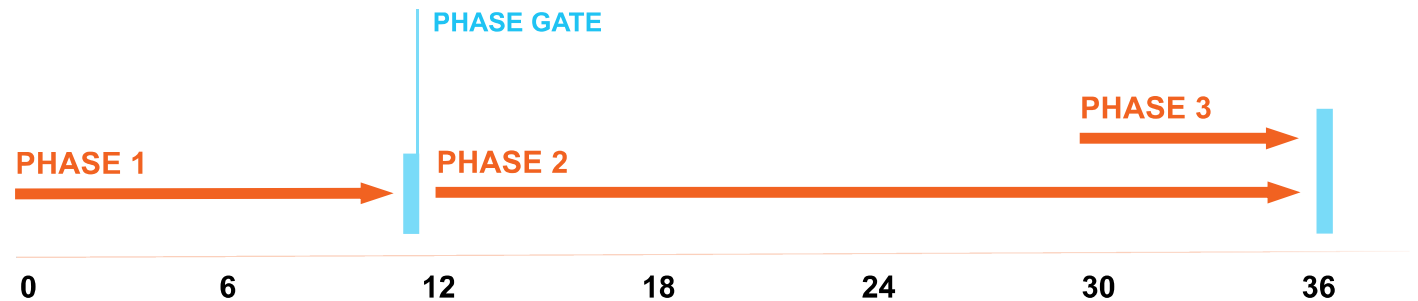

SEQUENTIAL RELATIONSHIP

Refers to a consecutive relationship between phases; phases occur in procession and without overlap.

OVERLAPPING RELATIONSHIP

A type of phase-to-phase relationship characterized by phases that start prior to the ending of the previous phase. Therefore, activities in different phases run concurrently with one another.



Phases produce one or more deliverables; outputs from one phase are generally inputs to the next phase.

They can have **sequential** or **overlapping relationships**.

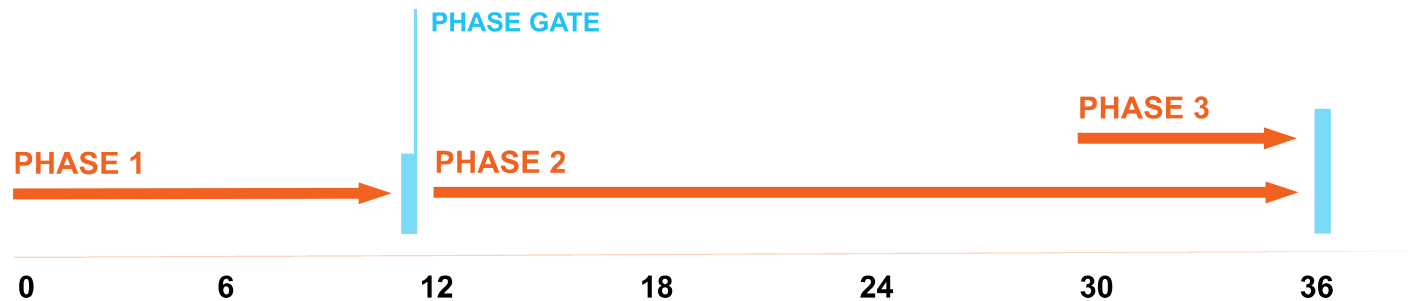

Apply Governance to Predictive Project Phases



PHASE 1

PHASE 2

PHASE 3

At the beginning of a phase:

- Verify and validate project assumptions
- Analyze risks
- Provide detailed explanation of phase deliverables

At the end:

- Key deliverables produced
- Review to ensure completeness and acceptance



If huge risks are encountered, deliverables are no longer needed or requirements change, a phase or project will be terminated.

ECO Coverage

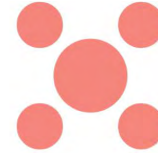

2.14 Establish project governance structure

- Determine appropriate governance for a project (e.g., replicate organization governance) (2.14.1)
- Define escalation paths and thresholds (2.14.2)

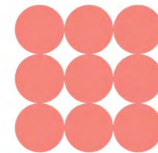
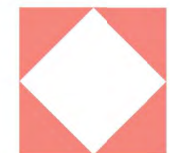
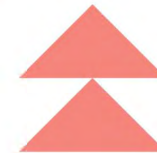



Project Compliance

TOPIC F

Compliance

-
- Internal and external standards include:
 - Government regulations
 - Corporate policies
 - Product and project quality
 - Project risk
 - PMO monitors compliance at organizational level
 - Project team is also responsible for project activity-related compliance, including:
 - Quality of processes and deliverables/products
 - Procurement and work by vendors

Compliance Requirements

Legal or regulatory constraints include:

- Requirements for specific practices
- Standards
- Privacy laws
- Handling of sensitive information

Quality: Tailor to your project — How much process rigor and quality control is relevant?



Compliance Categories Classification

-
- Environmental risks
 - Workplace health and safety
 - Ethical/noncorrupt practices
 - Social responsibility
 - Quality
 - Process risks

Categories vary based on:

- Industry and solution scope
- Unique legal and regulatory exposure

Compliance Threats

How to Investigate

-
- Where/who in the organization handles compliance?
 - What legal or regulatory requirements impact the organization? e.g. workplace safety, data protection, requirements for professional memberships
 - What is the organization's **quality policy**?
 - Are the team and stakeholders aware of compliance matters?



QUALITY POLICY

The basic principles that should govern the organization's actions as it implements its system for quality management.

-
- Where/who in the organization handles compliance?
 - What legal or regulatory requirements impact the organization? e.g. workplace safety, data protection, requirements for professional memberships
 - What is the organization's **quality policy**?
 - Are the team and stakeholders aware of compliance matters?

Treat Compliance as a Project Objective

-
- Proactively track and manage risks for compliance requirements
 - Be prepared to perform quality audits
 - Continuously validate legal and regulatory compliance for deliverables
 - Check compliance before the end of the project to avoid transferring issues
 - In a risk or dedicated compliance register, include:
 - The identified risk
 - A responsible risk owner
 - Impact of a realized risk
 - Risk responses



Larger organizations or those in highly regulated industries typically have a compliance department or officer.

Compliance

Five Best Practices

-
- **Documentation:** Updated compliance needs and risks
 - **Risk planning:** Prioritize compliance in risk planning
 - **Compliance council:** Includes quality/audit specialists and relevant legal/technical specialists
 - **Compliance audit:** Formal process
 - **Compliance stewardship:** It's your responsibility!

Interactive/Activity



Let's talk about compliance.

- Does your organization have a quality policy?
- Do you know where to find the quality policy or standards for your projects?
- What kinds of compliance activities are you involved with?



ECO Coverage

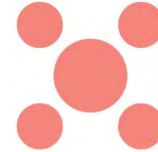

3.1 Plan and manage project compliance

- Confirm project compliance requirements (e.g., security, health and safety, regulatory compliance (3.1.1))
- Classify compliance categories (3.1.2)
- Analyze the consequences of non-compliance (3.1.5)

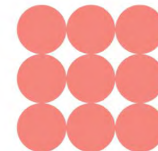
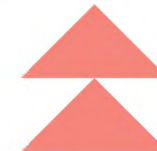

LESSON 2

START THE PROJECT

- Identify and Engage Stakeholders
- Form the Team
- Build Shared Understanding
- Determine Project Approach

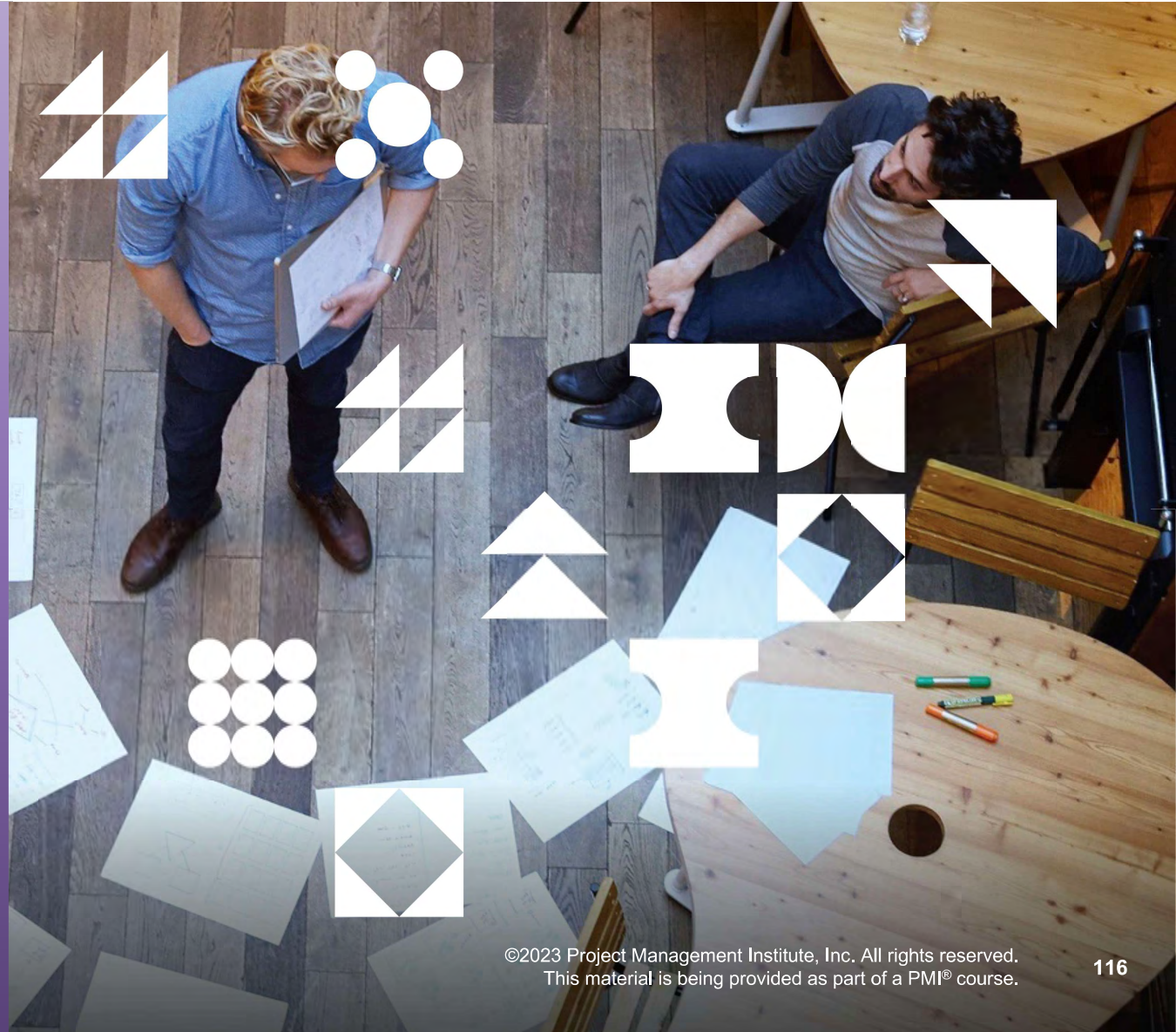

Learning Objectives

- Define and discuss stakeholders and the most effective ways to communicate with them.
- Explain the best ways to form a team.
- Describe how to build the most effective understanding of a project and how doing so relates to executing a project successfully.
- Explain how predictive and adaptive project life cycles work; explain what a hybrid development approach is.
 - Decide which kind of development approach or life cycle is best suited for work.

Project Life Cycle Check-In

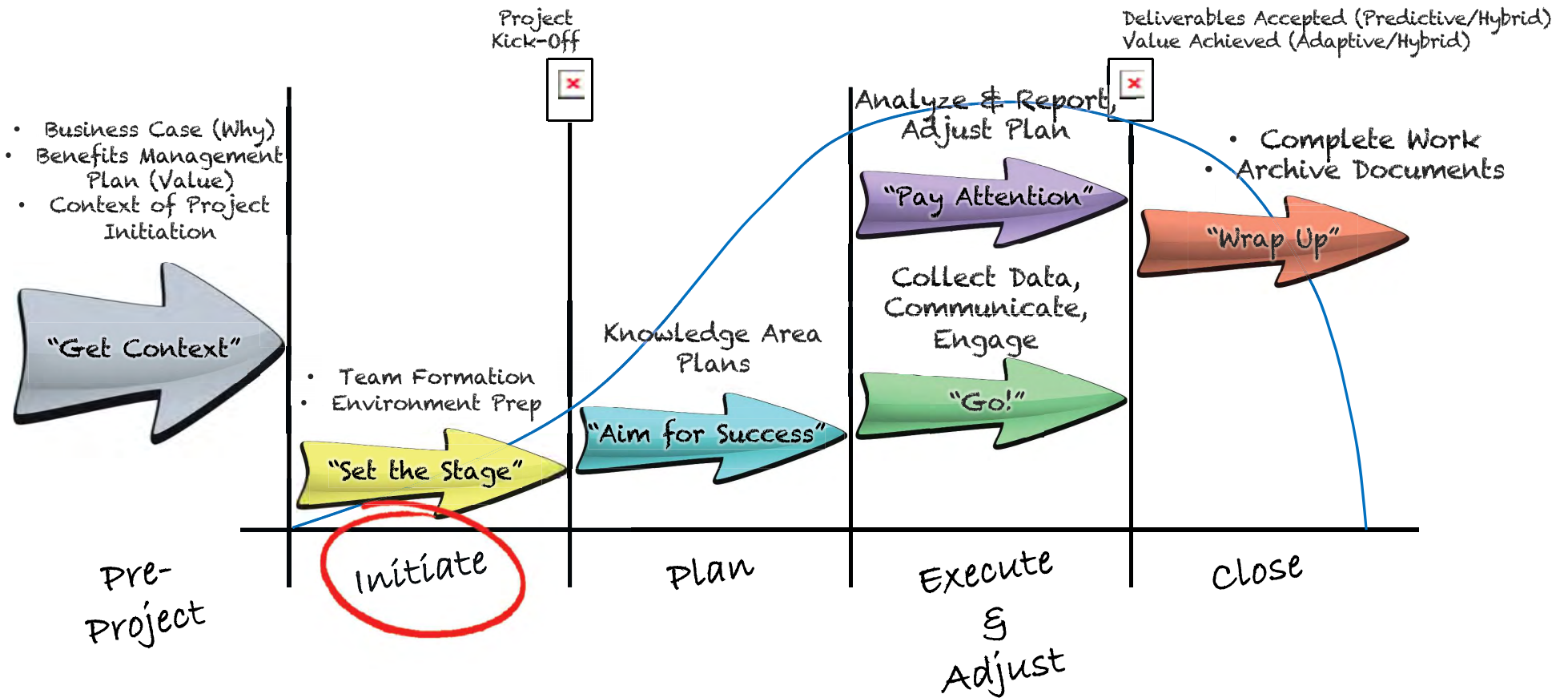

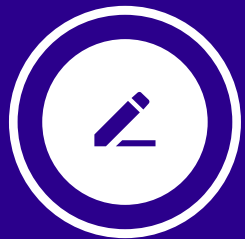

Identify and Engage Stakeholders

TOPIC A

Typical Project Stakeholders*



Can you categorize these stakeholders?

- Which are typically project team members?
Which are not?
- Which are typically active in project work?

-
- End users
 - Customers
 - Employees
 - Organization
 - Managers
 - Sponsors
 - Business partners
 - Suppliers and contractors
 - Government
 - Community





STAKEHOLDER

An individual, group or organization that may affect, be affected by or perceive itself to be affected by a decision, activity or outcome of a project, program or portfolio.

-
- End users
 - Customers
 - Employees
 - Organization
 - Managers
 - Sponsors
 - Business partners
 - Suppliers and contractors
 - Government
 - Community

Stakeholder and Communications Management Overview

- Stakeholder register
- Stakeholder engagement plan
- Communications management plan
- Stakeholder engagement assessment matrix (SEAM)
- Assessment grids / matrices / models

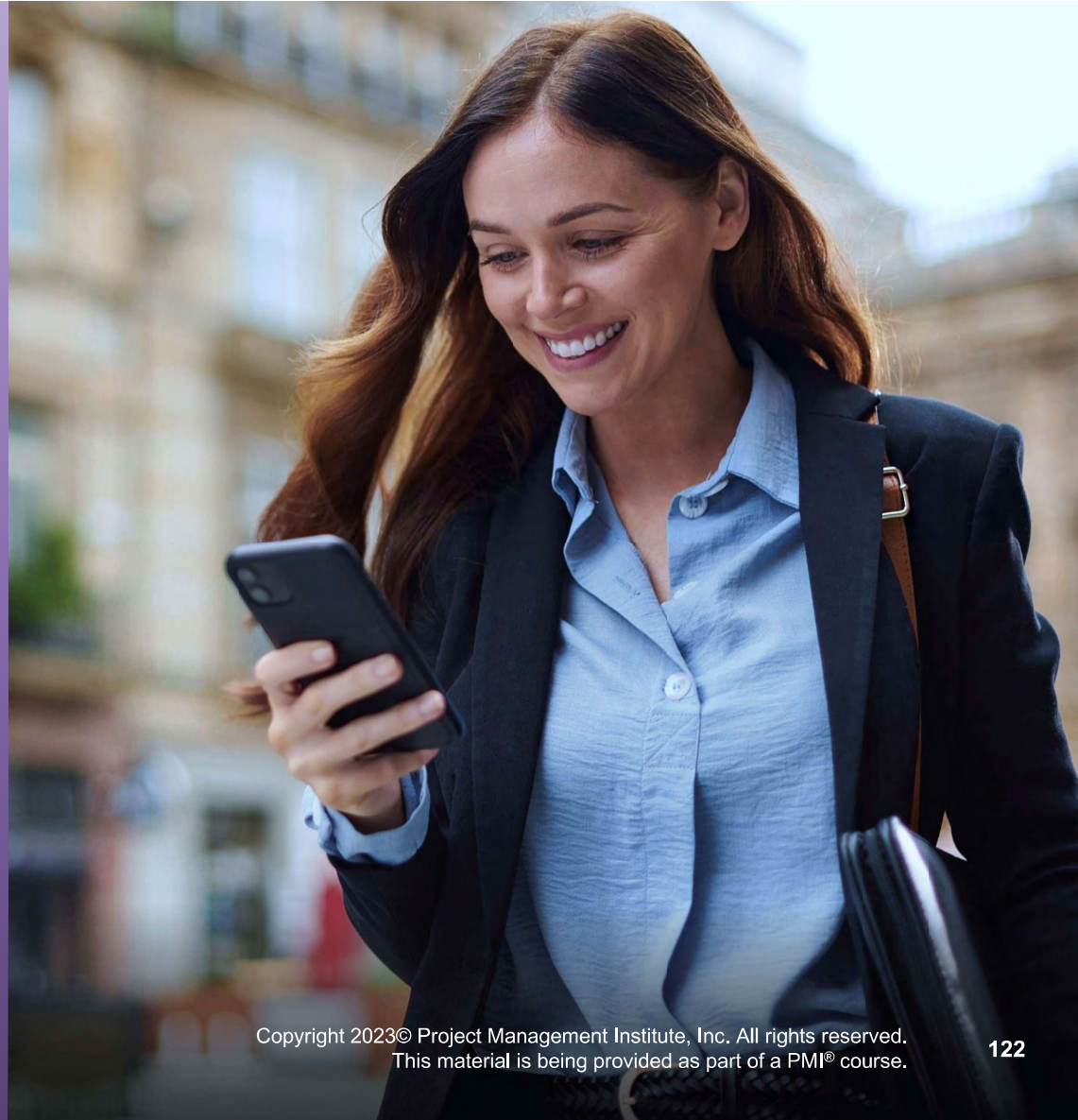

Stakeholder Identification

Who are they?

- Check the **business case** and **benefits management plan** for names
- Later, check the **issue/impediments log**, **change log** or **requirements documents** to see who else is needed or named

What's their relationship to the project?

- Interest
- Involvement
- Interdependencies
- Influence
- Potential impact on project success



Identify and engage stakeholders early to avoid surprises later in the project!

Assess Stakeholders

Data Gathering

- Questionnaires and surveys
- Brainstorming

Data Analysis

- **Stakeholder analysis** — What are their “stakes” in the project? — i.e., interest, rights, ownership, knowledge, contribution
- Document analysis

Data Representation

- Two-dimensional (2D) grids
 - Power/interest
 - Power/influence
 - Impact/influence
- 3D grid — Stakeholder “cube”
- Salience model
- Directions of influence

STAKEHOLDER ANALYSIS

A technique of systematically gathering and analyzing quantitative and qualitative information to determine whose interests should be considered throughout the project.

Data Gathering

- Questionnaires and surveys
- Brainstorming

Data Analysis

- **Stakeholder analysis** — What are their “stakes” in the project? — i.e., interest, rights, ownership, knowledge, contribution
- Document analysis

Data Representation

- Two-dimensional (2D) grids
 - Power/interest
 - Power/influence
 - Impact/influence
- 3D grid — Stakeholder “cube”
- Salience model
- Directions of influence

Create the Stakeholder Register

-
- Capture and record important stakeholder information
 - Factor in OPAs
 - Update it! Describe the evolving relationship with stakeholders throughout the project



Contains the information necessary to execute the stakeholder engagement plan



- Refer to **stakeholder registers** from previous, similar projects for help
- Remember this is a public document, so ensure the information presented is appropriate

STAKEHOLDER REGISTER

A project document including the identification, assessment, and classification of project stakeholders.

-
- Capture and record important stakeholder information
 - Factor in OPAs
 - Update it! Describe the evolving relationship with stakeholders throughout the project



Contains the information necessary to execute the stakeholder engagement plan



- Refer to **stakeholder registers** from previous, similar projects for help
- Remember this is a public document, so ensure the information presented is appropriate

Stakeholder Register



	Name	Title	Internal / External	Project Role	Major Requirements	Expectations	Influence / Attitude
1	Eugene Lowe	CEO	Internal	Sponsor	Successful completion	On-time completion, successful partnerships	Champion
2	Oasestown Municipality		External	Government partner (liaison); funding contributor; owner of SLC site	Successful completion of facility and partnership;	Accountability	Supporter
3	Kara Black	Principal, Oases Architects	External	Partner, designer, specialist knowledge (conservation building)	Clear design brief, successful partnership	Fluid funding and communication, design autonomy	Champion
4	Josie Bynoe	Chair, BOD	Internal	Direct strategic local partnerships for Shawpe	Environmental sustainability of project work; "moral rights"	No damage to Oasestown conservation district or environs	Resistor
5	Helen Grey	Lead, business development	Internal	Product owner	High profile tenants, excellent community and conservation credentials	Organizational learning; leadership opportunity	Neutral
6	Hasan Persaud	VP of Business Development	Internal	Portfolio owner	Capacity for ongoing revenue	End-user in Phase 3	Neutral
7	Mandeep Chahal	VP of Finance	Internal	Budget controller	direct contact with funding partners	clear data	Neutral
8	Kei Leung	VP of Marketing	Internal	Marketing expert	elevation of brand	high quality tenants	Supporter
9	Tenants		External	Income source	bespoke spaces	high quality	Neutral
10	Contractors		External	Vendors - building	clear instructions, contract		Neutral
11	Oasestown local residents		External	Neighbors to project	Traffic and noise pollution management	no inconveniences	Resistor
12	Oasestown Community Partnership		External	Community group operating in Oasestown	none	a free space in the SLC	Champion

Know Your Stakeholders

Go Beyond Job Titles

Power

Level of authority

Interest

Level of concern about project outcomes

Influence *aka attitude or impact*

- Ability to influence project outcomes or cause changes to planning or execution
- Magnitude of potential contribution or disruption to project

Use a descriptive term — e.g., champion, supporter, neutral, detractor



Tailor stakeholder assessments to suit project needs. The goal of this exercise is to facilitate your planning of effective communication with the stakeholders!

Stakeholder Mapping

Use two dimensions to map stakeholders:

- **Power** and **interest** grid
- **Power** and **influence** grid
- **Impact** and **influence** grid

Or use three dimensions – a **cube** – to refine the analysis further!

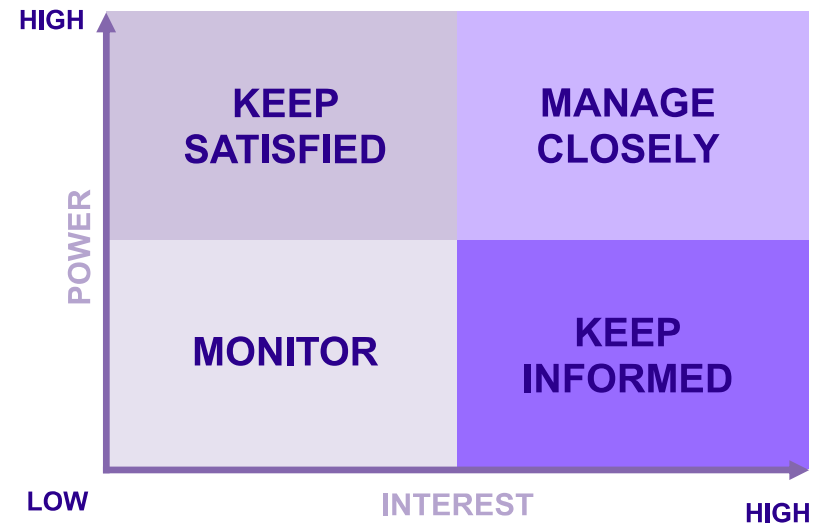
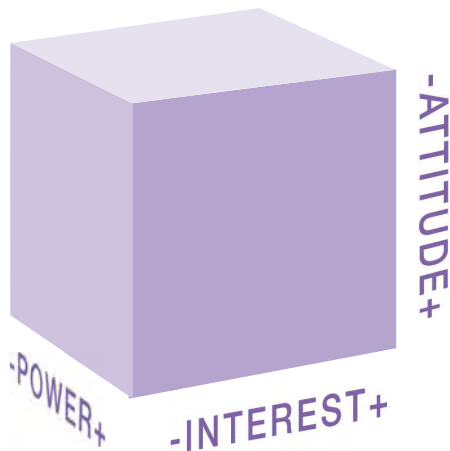

Method:

- Place each stakeholder on the grid (*do not use names*)
- Use the same quadrant labels, but change the axis labels

Directions of Influence



You should understand the social network of project stakeholders, specifically the direction of their influence on the project.

Upward	<i>Parent organization</i> — senior management (business, financial interests)
Downward	<i>In the project hierarchy</i> — team or specialists
Outward	<i>Have a “stake” in the project</i> — client, end-user, external
Sideward	<i>Friendly or competitive for resources</i> — project manager's peers, other organizational departments

Saliency Model



Focus on the **product owner** role. Are they familiar, interested and engaged enough with the project to make decisions and move the project forward?

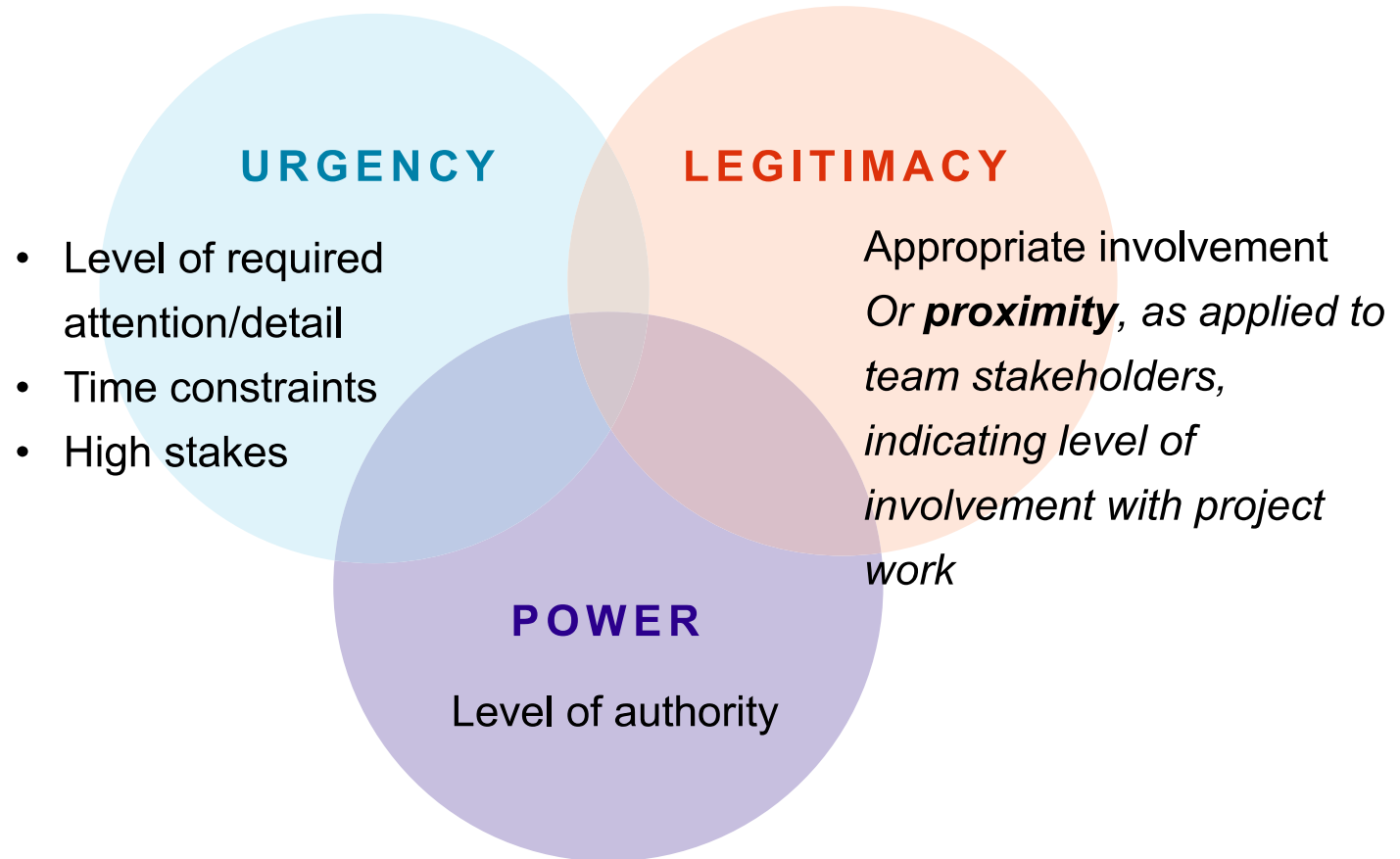

Stakeholder Perceptions

- Must be holistically understood in customer-centric project management approaches
- Can be damaging to a project, whether they are negative or positive



Why do you think it's important to understand both positive and negative stakeholder perceptions of your project?



Capture Stakeholder Feedback and Perceptions



- *Interpersonal skills*
- *Active listening*
- *Emotional intelligence*
- *Effective communication methods*



Key stakeholders

- Interview to understand **project requirements and vision** and **communication preferences**



All stakeholders

- Appropriate, regular project communications



Large and public groups

- Questionnaires/surveys
- Facilitated conversations/sessions — online or in person
- Digital media – email campaigns, websites, group chats
- Posters and advertising

Plan to Communicate with Stakeholders

Stakeholder engagement plan identifies required management strategies to effectively engage stakeholders.

Team fulfills strategies via communications described in the **communications management plan**.



STAKEHOLDER ENGAGEMENT PLAN

A component of the project management plan that identifies the strategies and actions required to promote productive involvement of stakeholders in project or program decision-making and execution. Used to understand stakeholder communication requirements and the level of stakeholder engagement in order to assess and adapt to the level of stakeholder participation in requirements activities.

COMMUNICATIONS MANAGEMENT PLAN

A component of the project, program, or portfolio management plan that describes how, when, and by whom information about the project will be administered and disseminated.

Stakeholder engagement plan identifies required management strategies to effectively engage stakeholders.

Program fulfills strategies via communications described in the **communications management plan**.

Communication Requirements Analysis



-
- Leads to a clear articulation of the stakeholders' communications needs
 - Enables effective choices about communication topics, frequency, models and technologies
 - Output is a grid, questionnaire or survey that documents the communication and technology requirements for each stakeholder

Communication: Methods and Technologies



Do you use any other communication methods or techniques on your projects?

Are there types your organization does not allow? Why?

Meetings/verbal

- Physical (face to face)
- Virtual (videoconferencing)
- Phone call

Digital/electronic media

- Websites and social media
- Instant/text messaging via phone or platform
- Email or fax

Physical

- Body language and gestures
- White boards

Communication Methods

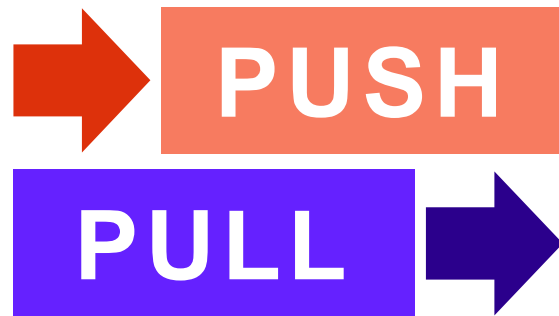

Push — sender determines:

- Send an email
- Make a phone call

Pull — receiver determines:

- Post information on team board
- Store reference documents in electronic repository — e.g., SharePoint



- Conversation (speaking on the phone, virtual, in-person)
- Messaging
- Workshops/collaboration
- Whiteboarding



Agile teams are colocated whenever possible so that they can be highly collaborative.

Communication Challenges / Considerations



-
- Urgency of need for information
 - Availability and reliability of technology
 - Ease of use
 - Project environment – e.g., language and formality
 - Sensitivity and confidentiality of information
 - Communications OPAs — e.g., social media protocols
 - Data protection laws/regulations
 - Accessibility requirements

Communication Channels



Communication Channels

Spotlight Series

This presentation shines the spotlight on Communication Channels!



Communication Model*



Think of an example of a transmission. Depending on the method, what kinds of noise can play a part?

Cross-Cultural Communication Model

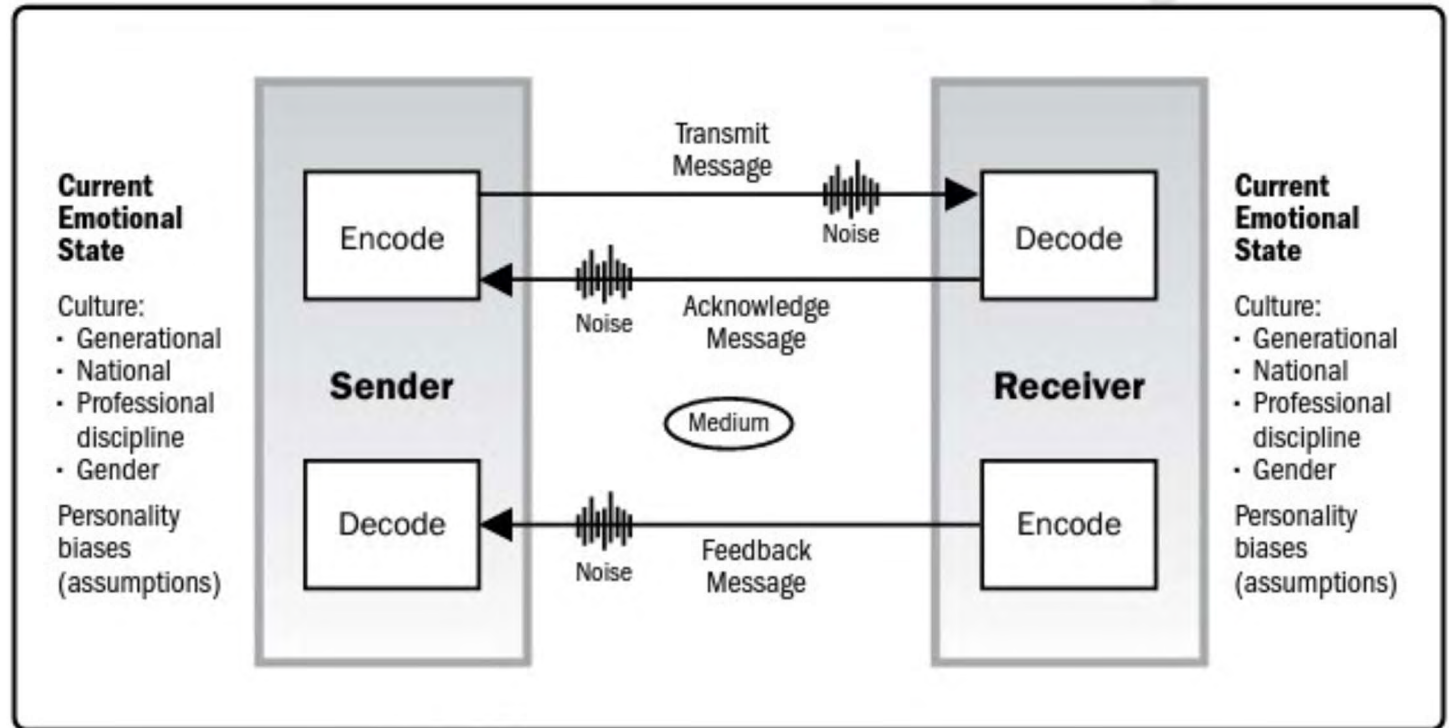

COMMUNICATION MODEL

A description, analogy, or schematic used to represent how the communication process will be performed for the project.

Cross-Cultural Communication Model

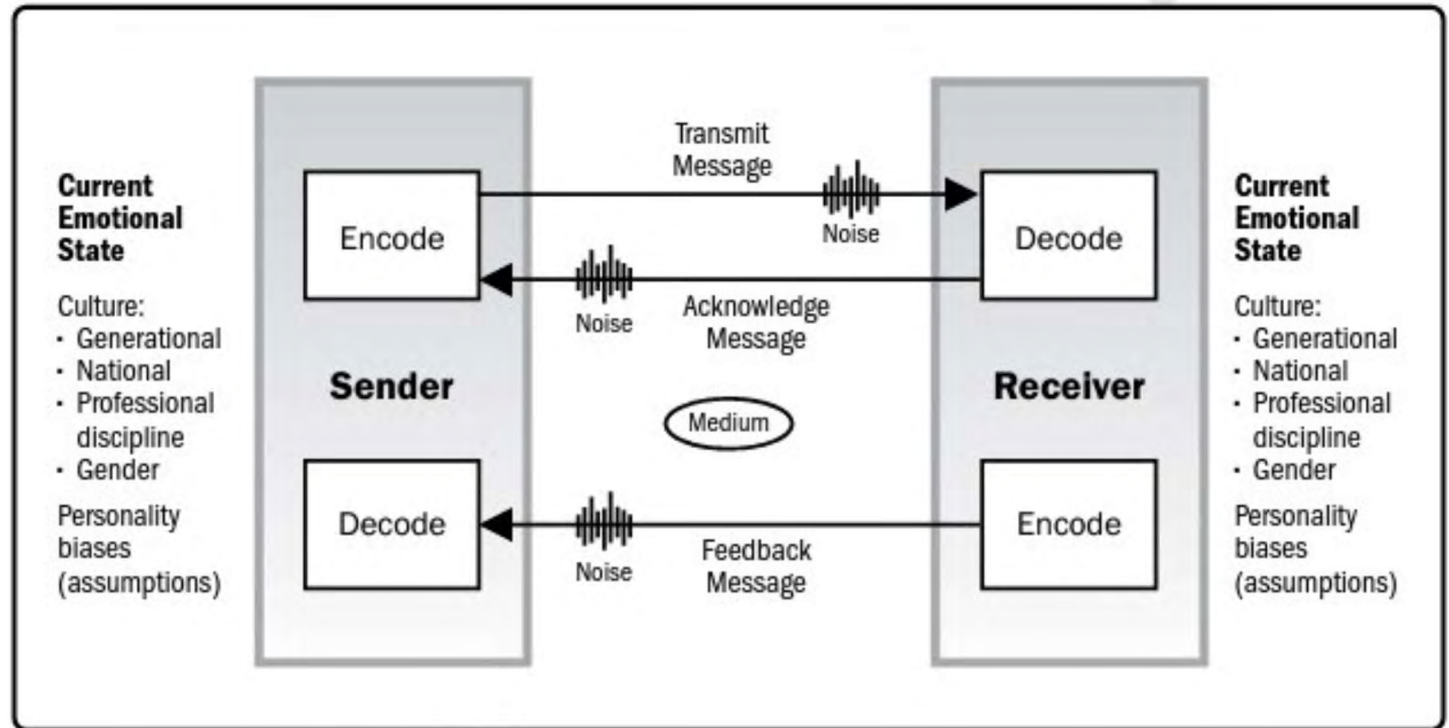

Stakeholder Engagement Strategy



-
- **Involve** stakeholders
 - **Enable** appropriate management strategies
 - **Create and maintain** relationships



Example Stakeholder Engagement Assessment Matrix (SEAM)

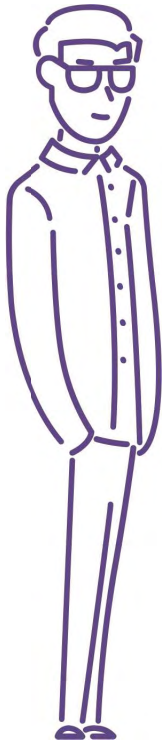

Tailor labels for stakeholder levels of engagement to your context, team or organization.

Don't use names on the matrix – refer to stakeholders by number.

Stakeholder	Unaware	Resistant	Neutral	Supportive	Leading
1				D	C
2				C	D
3			C	D	
4			C	D	
5		C	D		
6				C	D

C – Current engagement level | **D** – Desired engagement level

ECO Coverage

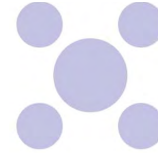

1.9 Collaborate with stakeholders

- Evaluate engagement needs for stakeholders (1.9.1)

2.4 Engage stakeholders

- Analyze stakeholders (power interest grid, influence, impact) (2.4.1)
- Categorize stakeholders (2.4.2)
- Develop, execute and validate a strategy for stakeholder engagement (2.4.4)

2.2 Manage communications

- Analyze communication needs of all stakeholders (2.2.1)
- Determine communication methods, channels, frequency and level of detail for all stakeholders (2.2.2)

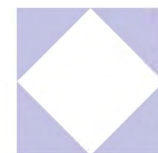
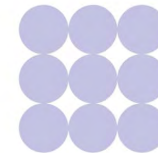
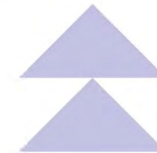



Form the Team

TOPIC B

Using Social Skills to Build Relationships



Using Social Skills to Build Relationships

Spotlight Series

Now we'll turn our spotlight on Using Social Skills to Build Relationships!



Create a Collaborative Team Culture



(Optional)

How do you think a collaborative team culture can be created in a hybrid approach? Give some examples!



Project manager:

- Builds team agreements, structures and processes that support a culture that enables individuals to work together and benefit from interactions
- Tailors a **resource management plan**



- The team assembles and self-organizes to support project requirements.

Project Team Formation Video

Tuckman's Ladder of Team Development

Dr. Bruce Tuckman



Project Team Formation

Key Concepts

Self-organizing team: A **cross-functional team** in which people fluidly assume leadership as needed to achieve the team's objectives.

Servant leadership: The practice of leading the team by focusing on understanding and addressing the needs and development of team members in order to enable the highest possible team performance.



These concepts can be applied in any kind of project team.



CROSS-FUNCTIONAL TEAM

Teams that have all the capabilities to deliver the work they've been assigned. Team members can specialize in certain skills, but the team is capable of delivering what they've been called on to build. See also "self-organizing teams."

Self-organizing team: A **cross-functional team** in which people fluidly assume leadership as needed to achieve the team's objectives.

Servant leadership: The practice of leading the team by focusing on understanding and addressing the needs and development of team members in order to enable the highest possible team performance.



These concepts can be applied in any kind of project team.

Project Manager Role in Adaptive Teams



Leadership and management models:

- **Centralized:** All team members practice leadership activities and accountability is usually assigned to one individual, such as the project manager or similar role (**team lead**).
- **Distributed:** One project team member (may shift) serves as facilitator to enable communication, collaboration and engagement on accountable tasks.



If a team is self-organizing, is a project manager needed?

- *If not, which of these models works best?*
- *If yes, what does that role look like?*

Hybrid Team Formation Example

Centralized coordination by a project manager or team lead and self-organized project teams for portions of the work

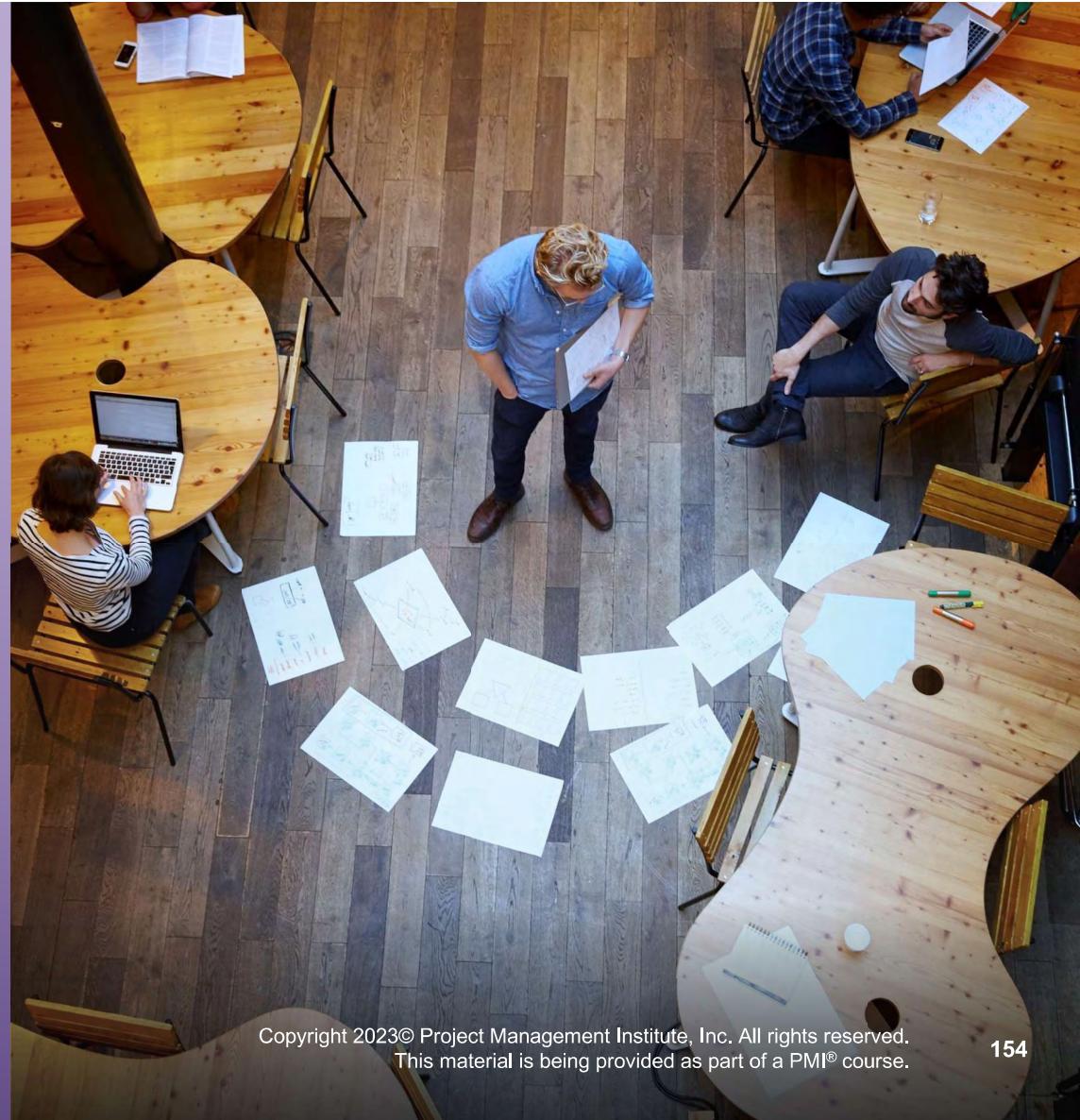

Project Team Composition

-
- Refers to team's makeup and how team members are brought together
 - Varies based on organizational culture, location and scope
 - Can be full-time or part-time members
 - Includes varied knowledge and expertise — i.e., generalists and specialists

Project Team Roles

- Project management staff
- Project work staff
- Supporting experts
- Business partners



Copyright 2023© Project Management Institute, Inc. All rights reserved.
This material is being provided as part of a PMI® course.

Identify Project Resource Requirements Guidelines

Provision team members, external contractors and suppliers and physical and intangible assets:

- Ensure relevant skill sets
- Avoid single points of failure — e.g., a single resource has a required skill
- Create **cross-functional teams**
- Use **generalizing specialists**, or **T-shaped** people, whenever possible to support other areas of the project
- Ensure appropriate physical resources and other requirements — e.g., equipment and access rights

GENERALIZING SPECIALISTS

Refers to a project team member who has a particular area of deep expertise but also has experience in many other areas that may not be directly related to their core area. These team member types are valued on agile projects because of their ability to be interchangeable.

T-SHAPED

Refers to a person whose skill set comprises one area of specialization and broad ability in other skills required by the team.

Provision team members, external contractors and suppliers and physical and intangible assets:

- Ensure relevant skill sets
- Avoid single points of failure — e.g., a single resource has a required skill
- Create **cross-functional teams**
- Use **generalizing specialists**, or **T-shaped** people, whenever possible to support other areas of the project
- Ensure appropriate physical resources and other requirements — e.g., equipment and access rights

T-Shaped People and Self-Organizing Teams

- Provide individual value and versatility on project teams
- Lend flexibility to organizations
- Help avoid key resource shortages or work stoppages due to availability
- Train and coach team members to become T-shaped, combining **breadth** and **depth** of knowledge



Diversity, Equity and Inclusion Standards

- Teams are global and diverse in culture, gender, physical ability, language and many other factors.
- The project environment optimizes the team's diversity and builds a climate of mutual trust.



Copyright 2023© Project Management Institute, Inc. All rights reserved.
This material is being provided as part of a PMI® course.

Experts and Expert Judgment

People from other areas of the organization

- Consultants
- Stakeholders
- Professional and technical associations
- Historical data
- Project manager



Focus on Team Strengths

- Organize around team **strengths**
- Be aware of **weaknesses**
- Identify **threats** to team success and **opportunities** to improve team performance



SWOT analysis



Copyright 2023© Project Management Institute, Inc. All rights reserved.
This material is being provided as part of a PMI® course.

Team Norms

-
- Together, **establish** expected team behaviors **at the beginning of the project**
 - Enable teams to **handle challenges** later
 - Include guidelines and techniques for:
 - Meetings
 - Communications
 - Conflict management
 - Shared values
 - Decision-making
 - Align team values with the *PMI Code of Ethics and Professional Conduct*

PMI® Code of Ethics and Professional Conduct



Can you remember the four values that drive ethical conduct for the project management profession?



Team Charter* and Ground Rules*



-
- A document – electronic or paper, or a poster of the ground rules
 - Created together with the team
 - Includes:
 - Shared values
 - Behavior guidelines
 - Guidelines for communications and use of tools
 - Decision-making guidelines
 - Performance expectations
 - Conflict-resolution measures
 - Meeting time, frequency, and channel
 - Other team agreements — e.g., shared hours, improvement activities

TEAM CHARTER

A document that records the team values, agreements, and operating guidelines as well as establishes clear expectations regarding acceptable behavior by project team members.

GROUND RULES

Expectations regarding acceptable behavior by project team members.

-
- A document – electronic or paper, or a poster of the ground rules
 - Created together with the team
 - Includes:
 - Shared values
 - Behavior guidelines
 - Guidelines for communications and use of tools
 - Decision-making guidelines
 - Performance expectations
 - Conflict-resolution measures
 - Meeting time, frequency, and channel
 - Other team agreements — e.g., shared hours, improvement activities

Team Charter Example

SHAWPE INDUSTRIES

PROJECT TEAM NAME: SHAWPE LIFESTYLE CENTRE
SPONSORING BUSINESS UNIT: EXECUTIVE / EUGENE LOWE
DURATION OF CHARTER: 36 MONTHS
OF PROJECT TEAM MEMBERS: 12
TEAM MEMBER TIME COMMITMENT: 40 HOURS PER WEEK

SCOPE OF WORK:

- Construct bespoke interior spaces appropriate for commercial tenants
- Restore historic buildings in site district for use as community spaces
- Recruit commercial and community tenants
- Create management structure and transfer to Casestown Municipality partner

PROJECT TIMELINES AND KEY MILESTONES

Milestone	Due Date	Measured By
PHASE 1	DEC 20XX	<ul style="list-style-type: none"> • Completion of interior spaces – obtain “safe occupancy” certificate • Recruit tenants
PHASE 2	DEC 20XX+1	<ul style="list-style-type: none"> • Tenants move in • Completion of outdoor spaces
PHASE 3	DEC 20XX +2	<ul style="list-style-type: none"> • Transfer of property management service

ADMINISTRATIVE/REPORTING REQUIREMENTS: All parties report directly to project manager

RESOURCES and BUDGET:

- Shawpe employees report to functional managers and project manager
- External contractors refer to SOW, report to project manager

PROJECT TEAM

Project manager: Ang Fen
Product owner: Helen Grey

TEAM MEMBERS:

- Daniel Ayan, Finance
- Greer Inniss, IT
- Janis Feather, Marketing
- Kareena Ayoung, Bus Dev
- Luis DeSouza, Executive
- Bel Jones, Marketing
- Solomon Grant, Marketing

SHAWPE INDUSTRIES

- **Project Team Executive Sponsor Roles and Responsibilities:**
 - Guide the project team to fulfill goals
 - Ensure all team members are fully oriented about the project vision at kickoff meeting.
 - Work with the project manager to ensure group work is carried out.
- **Project Manager Roles and Responsibilities:**
 - Guide the team in accomplishing the purpose detailed in the charter and in accordance with company policies.
 - Keep the team focused.
 - Work toward building a sense of trust, productivity, and camaraderie within the group.
 - Support a forum for open discussion and sharing of ideas.
 - Address non-productivity within the group.
 - Make decisions to support accomplishing the objectives of the team.
 - Coordinate all administrative duties in support of the group.
 - Facilitate information gathering for meetings.
- **Project Team Member Roles and Responsibilities:**
 - Collaborate as a team to follow all process and procedures to complete the work of the team.
 - Ensure individual work for the team is carried out between meetings.
 - Collaborate with project manager and product owner on an as-needed basis.
 - Actively participate in team meetings.
- **Team Guidelines and Communication**
 - Working hours are 8am – 5pm for the office
 - On site working hours are posted on site and change daily; use security ID badges to enter site at any hour; hard hats and boots must be worn on site
 - Be polite
 - Respect everyone’s opinion
 - Speak to people directly and appropriately before airing grievances in public
 - People may be contacted outside of working hours, but they are not required to respond
 - Use relevant messages in work chats
 - Be on time to meetings
 - Ask for help when you need it
 - Communicate honestly and openly
 - Use email for essential communication, so read emails properly

GROUND RULES



Team Communication

-
- **Effective communication** includes:
 - Verbal
 - Written
 - Behavioral
 - Physical (notice boards)
 - Virtual
 - Include communication expectations and details in the **team charter**
 - Organize communications:
 - Facilitate team and stakeholder collaboration
Manage expectations
 - Check regularly to make sure it's working!
 - Plan and use **retrospectives** to discuss communications improvements

Colocated, Virtual or Both?



*What kind of team are
you on?*



Virtual Team*

- “Normal” in most workplaces
- Create opportunities for the organization:
 - Better skills at lower costs
 - Avoids relocation expenses
 - Work/life balance
- Rely on communication technology
- May have bonding challenges

Colocated Team*

- Interaction is easy
- Better bonding is facilitated
- Use of physical tools, collaboration and boards possible

VIRTUAL TEAM

A group of people with a shared goal who fulfill their roles with little or no time spent meeting face-to-face.

COLOCATION

An organizational placement strategy in which the project team members are physically located close to one another to improve communication, working relationships, and productivity.

Virtual Team*

- “Normal” in most workplaces
- Create opportunities for the organization:
 - Better skills at lower costs
 - Avoids relocation expenses
 - Work/life balance
- Rely on communication technology
- May have bonding challenges

Colocated Team*

- Interaction is easy
- Better bonding is facilitated
- Use of physical tools, collaboration and boards possible

Virtual Teams



Virtual Teams

Spotlight Series

In this presentation, we'll turn our spotlight on Virtual Teams!

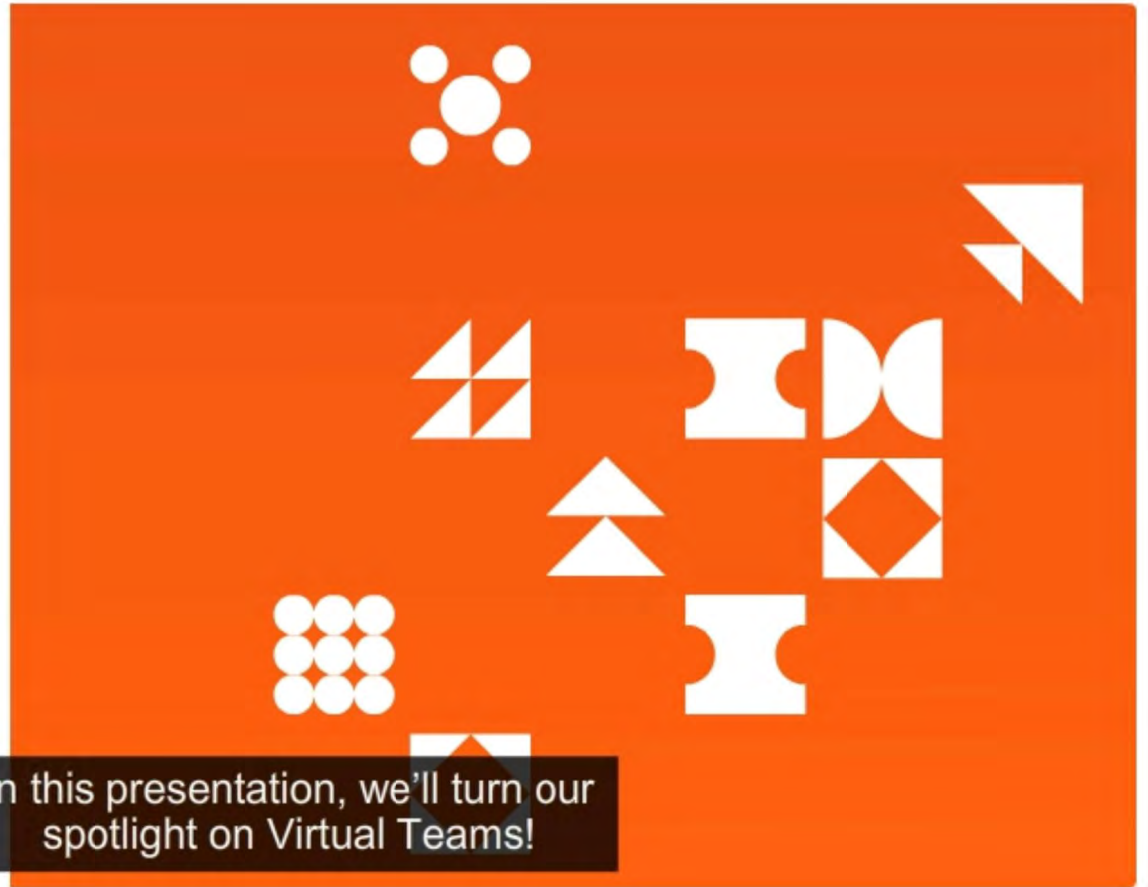

Virtual Team Challenges

- Individual performance tracking
- Diversity - language, technological skill
- Solo working prohibits bonding

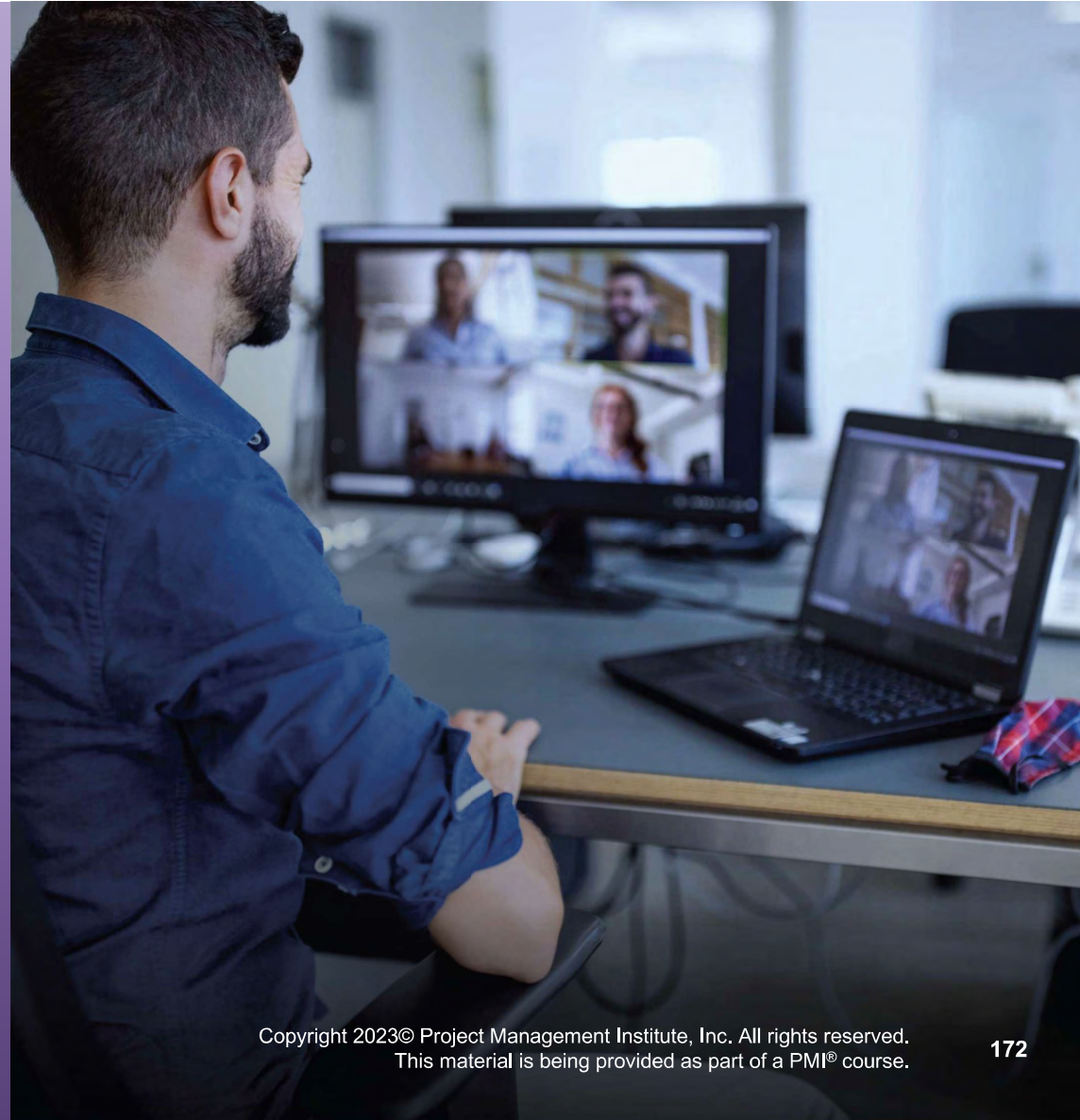

Running Virtual Teams

- Check in with people individually as often as possible
- Conduct positive network-building activities



What are your tips for creating a positive virtual team experience?



Virtual Team Communication Technology



- Plan team communication and collaboration methods
- Consider working hours, geographical dispersion and security requirements
- Use appropriate tools:
 - Task boards
 - Messaging and chat
 - Calendars
 - Document storage
 - Knowledge repositories
 - Videoconferencing

Address Virtual Team Member Needs

Facilitate and ensure collaboration as a priority

Address the basic needs of a virtual team, including:

- Cohesion
- Shared goals
- Clear purpose
- Clarity on roles and expectations



Copyright 2023© Project Management Institute, Inc. All rights reserved.
This material is being provided as part of a PMI® course.

ECO Coverage

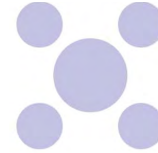

1.4 Empower team members and stakeholders

- Organize around team strengths (1.4.1)

2.16 Ensure knowledge transfer for project continuity

- Discuss project responsibilities within team (2.16.1)
- Outline expectations for working environment (2.16.2)

1.11 Engage and support virtual teams

- Examine virtual team member needs (e.g., environment, geography, culture, global, etc.) (1.11.1)
- Investigate alternatives (e.g., communication tools, colocation) for virtual team member engagement (1.11.2)

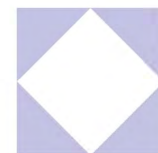
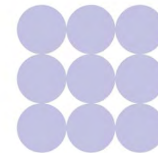
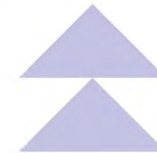

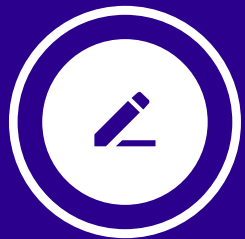

Build Shared Understanding

TOPIC C

Seek Consensus for the Project Among the Team and Stakeholders

- Demonstrate leadership behaviors
- Focus on value
- Be a diligent, respectful and caring steward
- Navigate complexity
- Embrace adaptability and resiliency

Create artifacts:

- Project charter
- Project vision statement

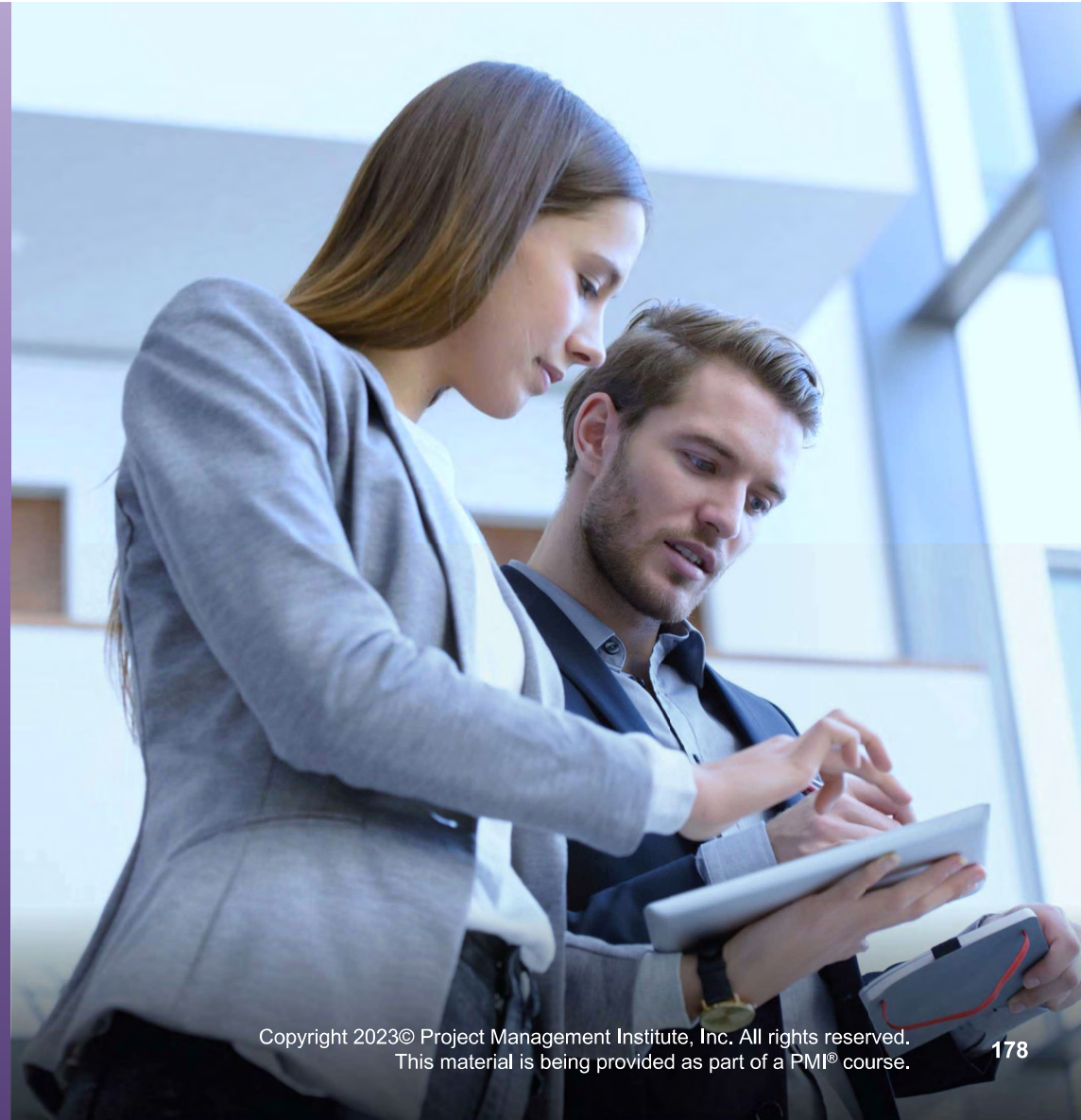

Building a Shared Understanding Guidelines

-
- **Share** the project agreements (vision statement and project charter) with stakeholders and the team
 - **Agree or negotiate** to reach agreement and “buy-in”:
 - Project agreements — stakeholders
 - Roles and responsibilities, priorities and assignments — team
 - **Uphold** the agreements throughout the project



Use open and reliable communication methods and your leadership “power skills”

Project Vision Statement

-
- Created by project sponsor or executive
 - Includes a **clear vision of the desired objectives** and **alignment with the organization's strategic goals**
 - Refer to it throughout the project to maintain alignment

Holistic Understanding of the Project Negotiation Goals

First, find out...

- The boundaries of negotiation for the project agreement
 - What, if anything, is eligible for discussion or troubleshooting
- The desired objectives of the project

Then:

- Apply critical thinking and business acumen
- Discover how the project fits in the organizational landscape and business objectives

How to Create a Holistic Understanding of the Project

-
- **Ask stakeholders** to elaborate and clarify their vision or inputs, including asking the sponsor to clarify the vision statement!
 - Existing **agreements** may contain initial intentions for, or describe, a project:
 - Contracts with external parties
 - Memorandums of understanding (MOUs)
 - Service-level agreements (SLAs)
 - Letters of agreement or intent
 - Verbal agreements
 - Communication (especially emails) between key stakeholders
 - Statements of work (SOW)

Refer to Business Case and Business Needs

Business case:

- A documented economic feasibility study
- Establishes benefits of project work
- Provides a basis for authorization of further project activities

Business needs documents:

- Identifies high-level deliverables
- A prerequisite of a formal business case
- Describes requirements — what needs creating and/or performing

Negotiate and Agree on Project Success Criteria

-
- Interview **stakeholders**
 - Gather **expert judgment** on technical success criteria
 - Check:
 - Organizational (program, operations) **key performance indicators (KPIs)**
 - Lessons learned and historical data
 - Quality policy
 - User acceptance testing (UAT) requirements



- *Reporting and verification criteria for objectives*
- *Identification of deliverable and objective **acceptance criteria** for each*



- *A **definition of done (DoD)** may be specified for the project, in addition to iteration outputs*

KEY PERFORMANCE INDICATORS (KPIs)

A set metric used to evaluate a project, an organizational unit, or a project team's performance against the project vision and objectives. KPI can be time bound.

-
- Interview **stakeholders**
 - Gather **expert judgment** on technical success criteria
 - Check:
 - Organizational (program, operations) **key performance indicators (KPIs)**
 - Lessons learned and historical data
 - Quality policy
 - User acceptance testing (UAT) requirements



- *Reporting and verification criteria for objectives*
- *Identification of deliverable and objective **acceptance criteria** for each*



- *A **definition of done (DoD)** may be specified for the project, in addition to iteration outputs*

Help Everyone Understand the Vision Guidelines



-
- Use interpersonal and leadership “power skills” and open communication channels with stakeholders and team members
 - Get creative with agile methods!



- A **product box exercise** to internalize the vision from the customer’s point of view and emphasize product/project value
 - **Example:** Here is why Oasestown residents will choose to spend their time and money at SLC (*followed by explanation of what it offers to customers*)



- The **XP metaphor** technique explains a complex idea in simple, familiar terms, using common language and vocabulary
 - **Example:** SLC is the living room of Oasestown!

PRODUCT BOX EXERCISE

A technique used to explain a desired solution or outcome. Stakeholders try to describe aspects of a solution in the same way a marketer might describe product features and benefits on a box.

XP METAPHOR

A common Extreme Programming (XP) technique that describes a common vision of how a program works.

-
- Use interpersonal and leadership “power skills” and open communication channels with stakeholders and team members
 - Get creative with agile methods!



- A **product box exercise** to internalize the vision from the customer’s point of view and emphasize product/project value
 - **Example:** Here is why Oasestown residents will choose to spend their time and money at SLC (*followed by explanation of what it offers to customers*)



- The **XP metaphor** technique explains a complex idea in simple, familiar terms, using common language and vocabulary
 - **Example:** SLC is the living room of Oasestown!

Got Agreement on the Project Agreements?



*There is no single way to create a **project charter**, but every project needs to have one!*



Copyright 2023© Project Management Institute, Inc. All rights reserved.
This material is being provided as part of a PMI® course.

Project Charter*

What it does and why it's important:

- Authorizes project
- Enables project manager to apply resources to project work
- Defines rationale and business need
- Verifies alignment with strategic goals
- Keeps everyone focused on a clear project vision



Usually created by project sponsor or project manager with executive/stakeholder approval. Sometimes a statement of work can serve as project charter.

PROJECT CHARTER

A document issued by the project initiator or sponsor that formally authorizes the existence of a project and provides the project manager with the authority to apply organizational resources to project activities.

What it does and why it's important:

- Authorizes project
- Enables project manager to apply resources to project work
- Defines rationale and business need
- Verifies alignment with strategic goals
- Keeps everyone focused on a clear project vision



Usually created by project sponsor or project manager with executive/stakeholder approval. Sometimes a statement of work can serve as project charter.

Project Charter Contents

What's included:

- **Names** - project sponsor, project manager, key stakeholders
- **Project description**, including preliminary requirements, measurable objectives
- **Business needs**, including financial goals or milestones
- Summary **schedule** and **milestones**
- **Assumptions, boundaries** and **constraints**, including overall risk, approval requirements and approved budget
- Information from the **business case**, including success and exit criteria

Project Charter: Example



PROJECT CHARTER

PROJECT NAME		PROJECT MANAGER	PROJECT SPONSOR
Shawpe Lifestyle Center (SLC)		Ang Fen	Eugene Lowe
EMAIL	PHONE	ORGANIZATIONAL UNIT	
ang.fen@shawpe.com	000.000.0000	Executive	
ESTIMATED COSTS	EXPECTED SAVINGS	EXPECTED START DATE	EXPECTED COMPLETION
\$10 Million	\$0	Jan 20XX	Dec 20XX+2

PROJECT OVERVIEW

PROBLEM OR ISSUE	Rehabilitate commercial property in downtown Oasestown
PURPOSE OF PROJECT	Establish a profitable commercial development and community partnership in Oasestown
BUSINESS CASE	Attached. Approved by E. Lowe and BOD at Oct 20XX meeting.
GOALS / METRICS	Building code and other local government compliance with historic district construction
EXPECTED DELIVERABLES	"Rehabilitate 128,000 sq metre indoor/outdoor space to meet municipality standards and compliance with National Heritage & Conservation Board (NHC) standards / Property management entity established with Oasestown partner / Secure 14-18 highly reputable commercial tenants"
RISK - CONSTRAINTS, ASSUMPTIONS	<ol style="list-style-type: none"> 1. Site in historical conservation zone 2. New vendors for specialist glasswork and masonry 3. Physical retail market stability 4. Resistant key stakeholder 5. Phase 3 financing dependent on success of Phases 1 and 2"

PROJECT SCOPE

WITHIN SCOPE	<ol style="list-style-type: none"> 1. Manage construction contractors and site development; 2. conduct marketing and advertising to secure 14-18 high-quality tenants to anchor commercial space; 3. Work with community partners to establish socially beneficial community spaces and programs; 4. Manage project budget (funded by external grant) within compliance;
OUTSIDE OF SCOPE	<ol style="list-style-type: none"> 1. architectural work - interior and exterior - Oases Architects 2. building work - XYZ General Contractors, ZYX specialist contractors 3. External grant fund management

TENTATIVE SCHEDULE

KEY MILESTONE	START	FINISH
Form Project Team / Preliminary Review / Scope	00/00/0000	00/00/0000
Finalize Project Plan / Charter / Kick Off	00/00/0000	00/00/0000
Phase 1	Design and build interior	00/00/0000
	Create contract with community groups	00/00/0000
	Recruit 14-18 tenants	00/00/0000
Phase 2	Design and build outdoor spaces	00/00/0000
	Install community programs	00/00/0000
	Secure 55M revenue in annual commercial rents	00/00/0000
Phase 3	Finalize all construction	00/00/0000
	Train SLC property management staff	00/00/0000

Kickoff Meeting

Purpose

- Establishes project context
- Assists in team formation
- Aligns team and stakeholders with project vision

Organizational/Public

- Announce project initiation
- Share understanding of high-level vision, purpose and value
- Identify sponsor, key stakeholders and project manager
- Include high-level items from the project charter

Internal/Team – held after agreements are finalized

- Give project charter overview
- Clarify team member roles and responsibilities (may include the initial team charter)
- Present results of planning efforts
- Initiate product backlog
- Present product roadmap



ECO Coverage

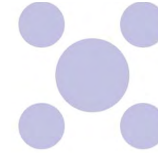

1.2 Lead a team

- Set a clear vision and mission (1.2.1)

1.8 Negotiate project agreements

- Analyze the bounds of the negotiation for agreement (1.8.1)
- Assess priorities and determine ultimate objective(s) (1.8.2)
- Participate in agreement negotiations (1.8.4)
- Determine a negotiation strategy (1.8.5)

1.10 Build shared understanding

- Survey all necessary parties to reach consensus (1.10.2)
- Support outcome of parties' agreement (1.10.3)

1.12 Define team ground rules

- Communicate organizational principles with team and external stakeholders (1.12.1)
- Establish an environment that fosters adherence to ground rules (1.12.2)

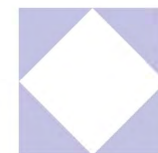
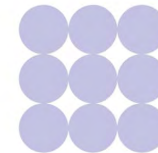
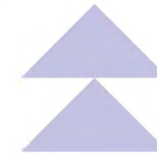



Project Approach

TOPIC D

First, Understand How and Why Approaches Differ

- Changing perceptions of value — e.g., sustainability, customer-centricity
- Dynamic and perpetual global change
- Increasing complexity and risk
- Need to innovate and be dynamic



Which project management frameworks do you use?

Do you have a preference?



Tailored Development Approaches

-
- Support **dynamic work environments**
 - Discover **value delivery requirements** early
 - Put stakeholders and the team in close collaboration



Advantages:

- Provide better feature or capability assessment — continuous improvement and quality
- Improve organizational tolerance for change



Servant leaders influence projects and encourage the organization to think differently.

Project Management Development Approaches

	Characteristics	Certainty About Requirements	Change and Risk
	<ul style="list-style-type: none"> • Plan-driven • Linear sequence of activities, in phases • Phase completion governed by phase gates 	High, from beginning	<ul style="list-style-type: none"> • Change possible, but controlled • Risks carefully studied and managed
	<ul style="list-style-type: none"> • Change-driven • Iterative or incremental • Timeboxed cadence (iterations/sprints) or continuous flow 	Unclear or customer-driven, so needs further discovery	<ul style="list-style-type: none"> • Built on assumption of high degree of change • High tolerance of risk with guardrails for risk management
	Tailored development approach, combining these elements		

Project or Product?

A product is part of a project; products have their own **life cycles**.

Product management represents a **key integration point** within program and project management.

Product owners are responsible for maximizing the value of the product and accountable for the end product.

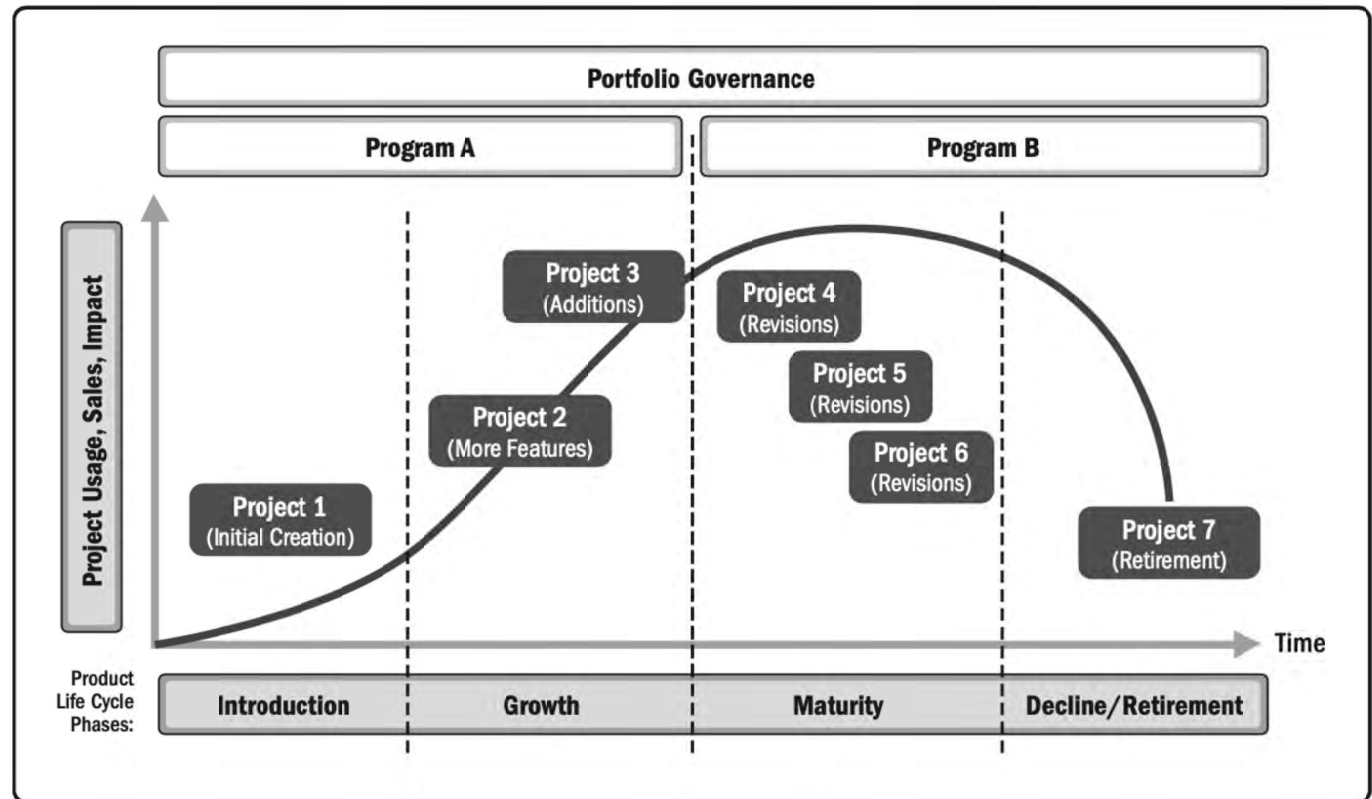

Can you explain why projects often have both a project manager and a product owner?



PRODUCT MANAGEMENT

The integration of people, data, processes, and business systems to create, maintain, and evolve a product or service throughout its life cycle.

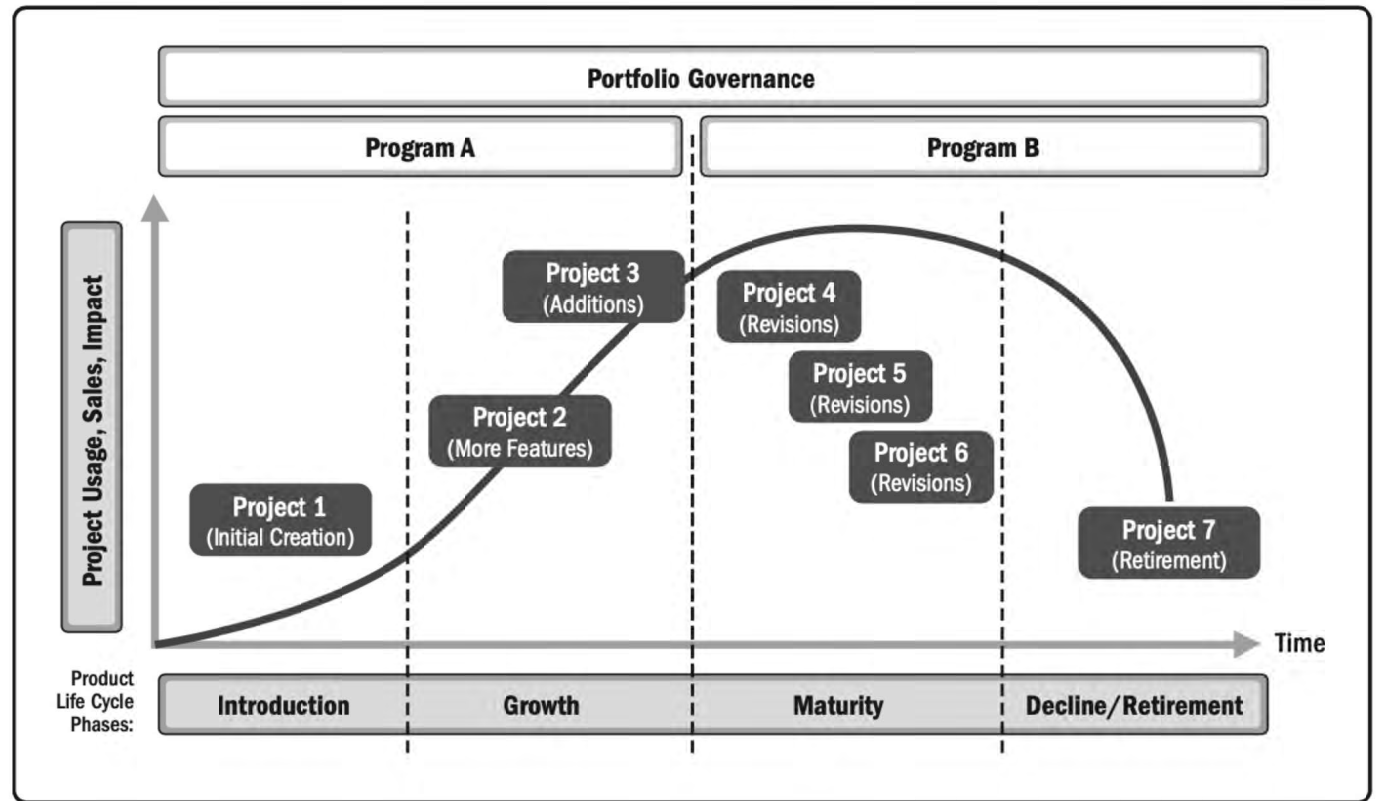

Can you explain why projects often have both a project manager and a product owner?

Life Cycle and Development Approach



Which type of life cycle is depicted here?

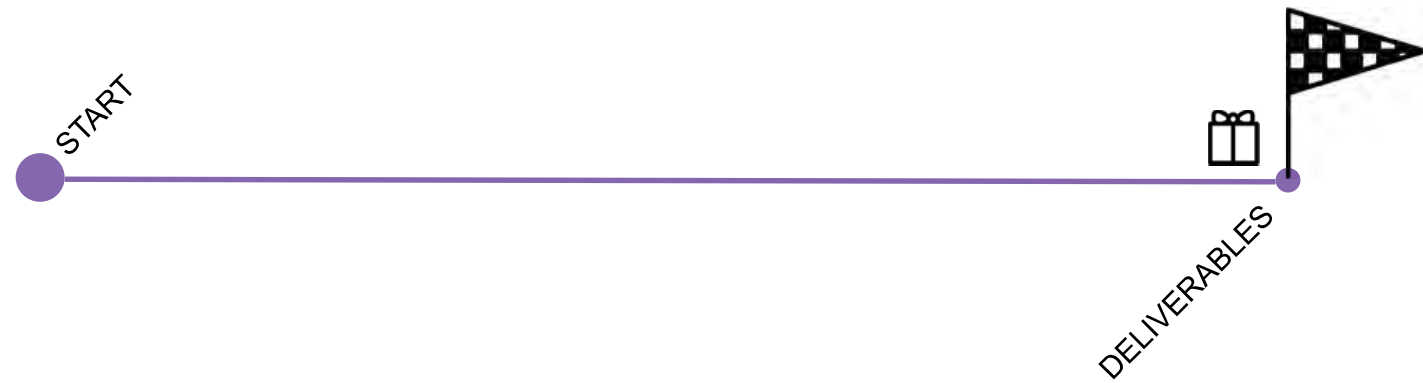

Predictive Life Cycle

Visual

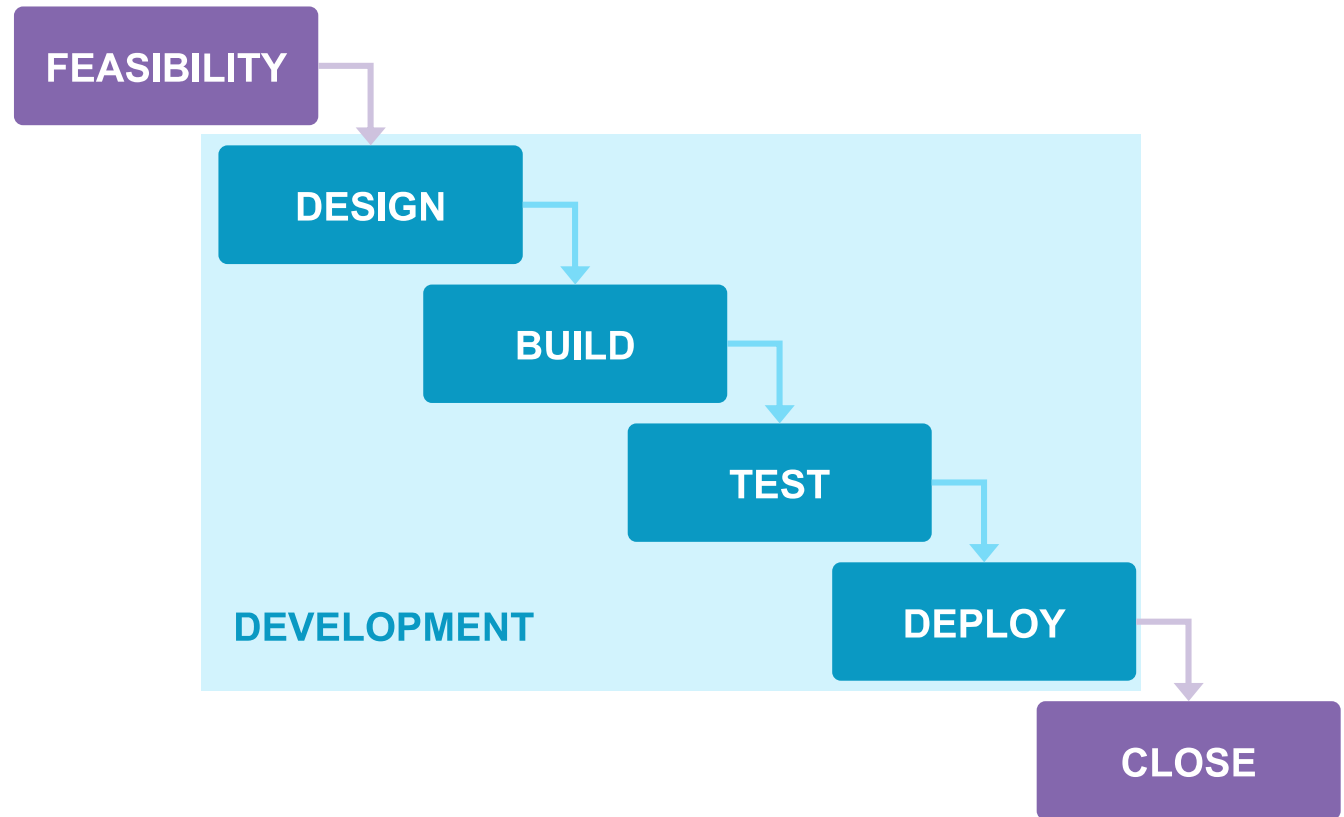

Adaptive Life Cycle

Example



Note the iterations on the graphic, then describe how this life cycle uses an incremental approach.

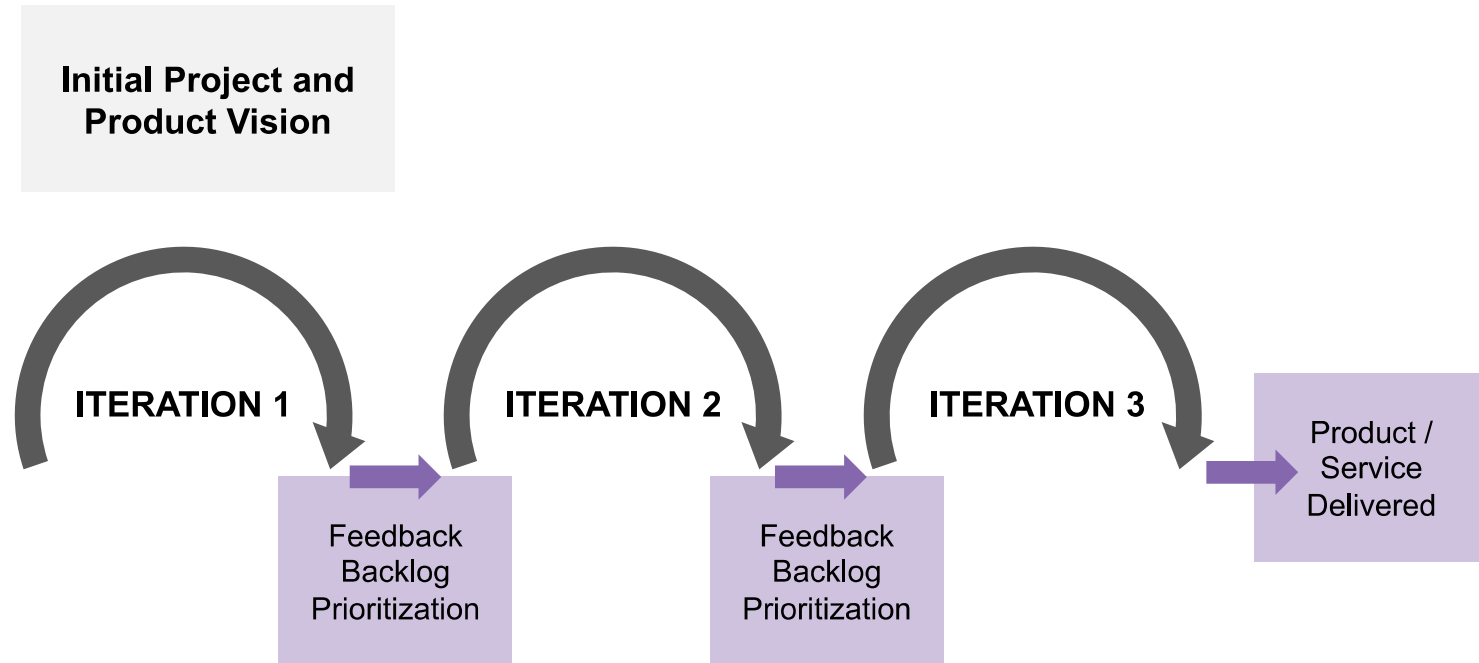

Cadence

Refers to the timing and frequency of delivery of project deliverables.

- **Single:** One delivery at the end of the project
- **Multiple:** Delivery separated into parts, not necessarily sequentially
- **Periodic:** Like multiple deliveries, but on a fixed schedule — e.g., monthly or bimonthly

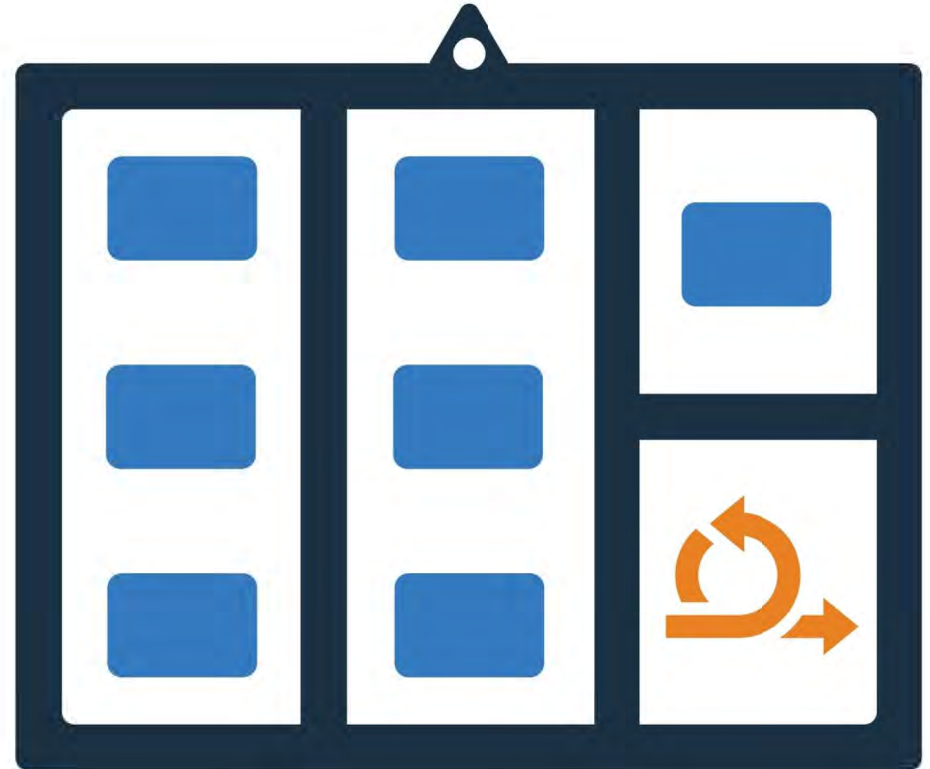

Adaptive Development Approaches

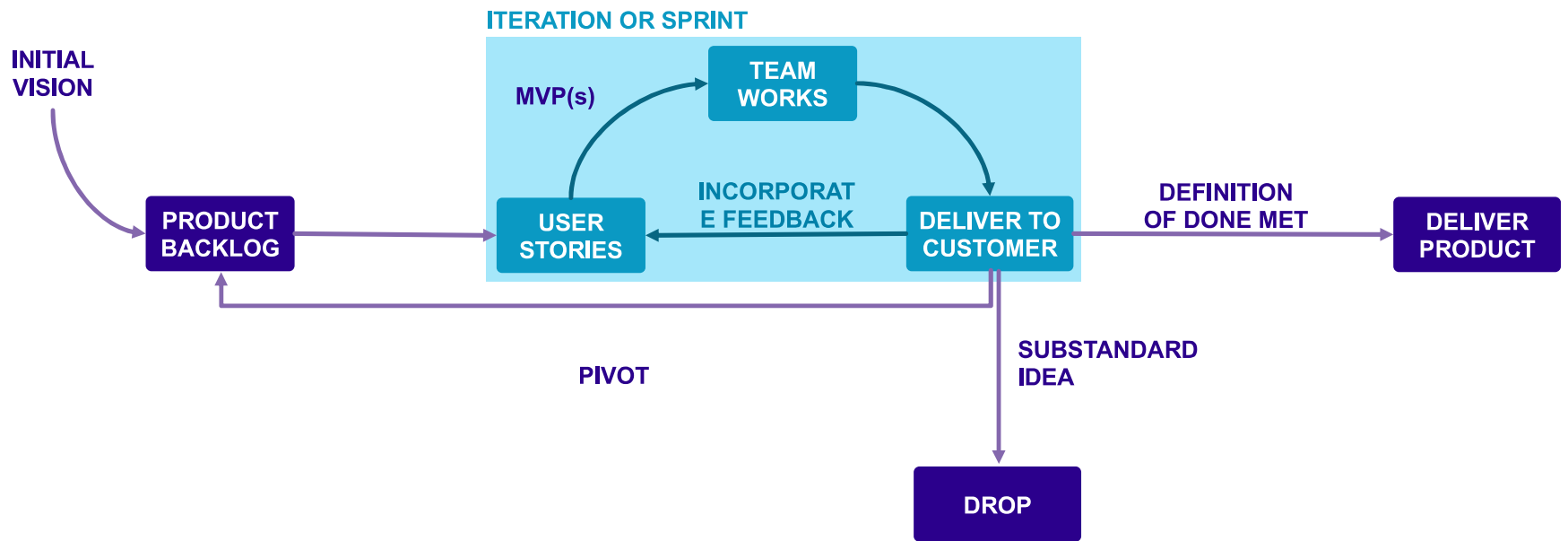

Cadence can be time-boxed with sprints/iterations or a continuous flow.

When to Apply Methodologies



When to Apply Agile Methodologies

Spotlight Series

In this presentation, you'll point the spotlight at
When to Apply Agile Methodologies

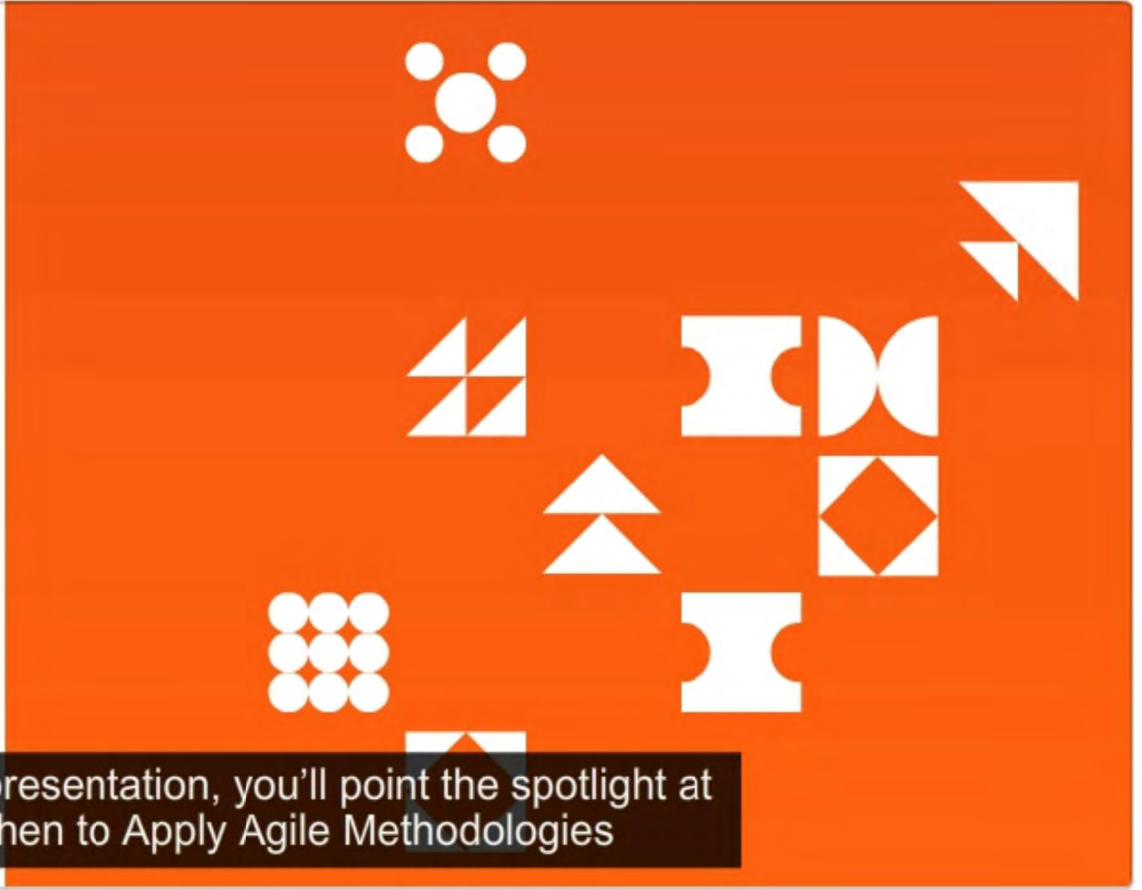

Development Approach and Life Cycle Terminology

Quiz

- Deliverable
- Development approach
- Phases
- Life cycle



Project professionals use a development approach or method, which can be predictive, iterative, incremental, adaptive, or hybrid, to create and evolve a deliverable, which is a unique and verifiable product, result, or capability to perform a service.

A project passes through a series of logically related activities, called phases from its start to its completion. This entire process is called a life cycle.

Acceptance of a deliverable is required to complete a process, phase, or project.

Hybrid Life Cycle and Development Approach



-
- Accomplished by tailoring
 - Combines adaptive and predictive life cycles and/or development approaches
 - Useful when requirements are uncertain or risky
 - Also useful when deliverables can be modularized, or when deliverables can be developed by different project teams
 - Uses iterative and incremental development

Hybrid Project Approaches: Examples



-
- Use agile or iterative practices within a predictive framework
 - Use predictive artifacts or processes within an adaptive life cycle
 - Business analysis techniques assist with requirements management
 - New tools help identify complex elements in projects
 - Organizational change management methods prepare for transitioning project outputs into the organization

What Can Be Tailored?



-
- Project life cycle
 - Development life cycle components
 - Way of working (WoW)
 - Knowledge management
 - Change management
 - Project governance
 - Benefits management

Development Approaches

Guidance and Probing Questions

-
- Deliverable type and the **development approach** influence the **number and cadence** for project deliveries.
 - The development approach and the desired delivery cadence determine the **project life cycle** and its **phases**.

 - How much unplanned work?
 - How does the team prefer to work?
 - What cadence suits our work?
 - What does the customer want? Is incremental value delivery even important to them?
 - What's our schedule? Do we want a steadier, building approach or a faster pace?
 - What's our risk appetite/threshold?
 - Are sprints helpful?

Assess Complexity: The Stacey Complexity Model

-Ralph D. Stacey

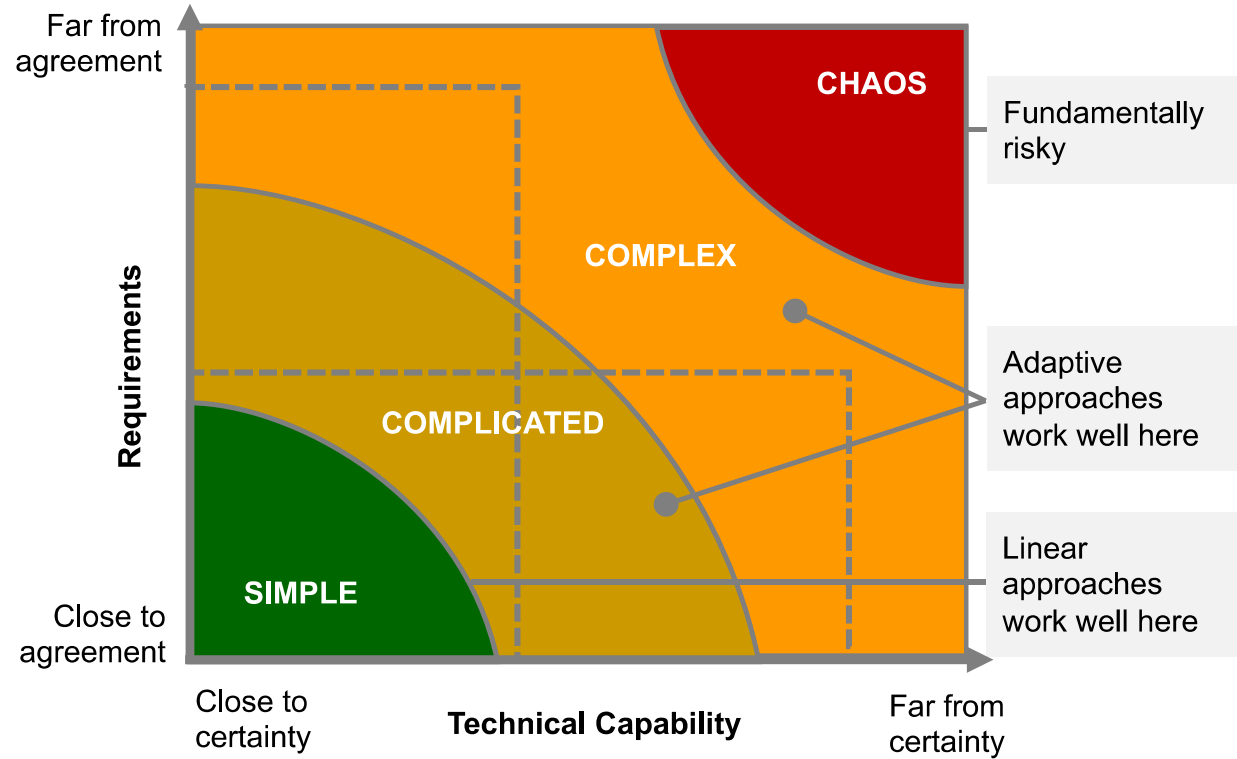

Suitability Filter:

A Diagnostic Visual Based on Survey Data



Iterative and Incremental: Overview

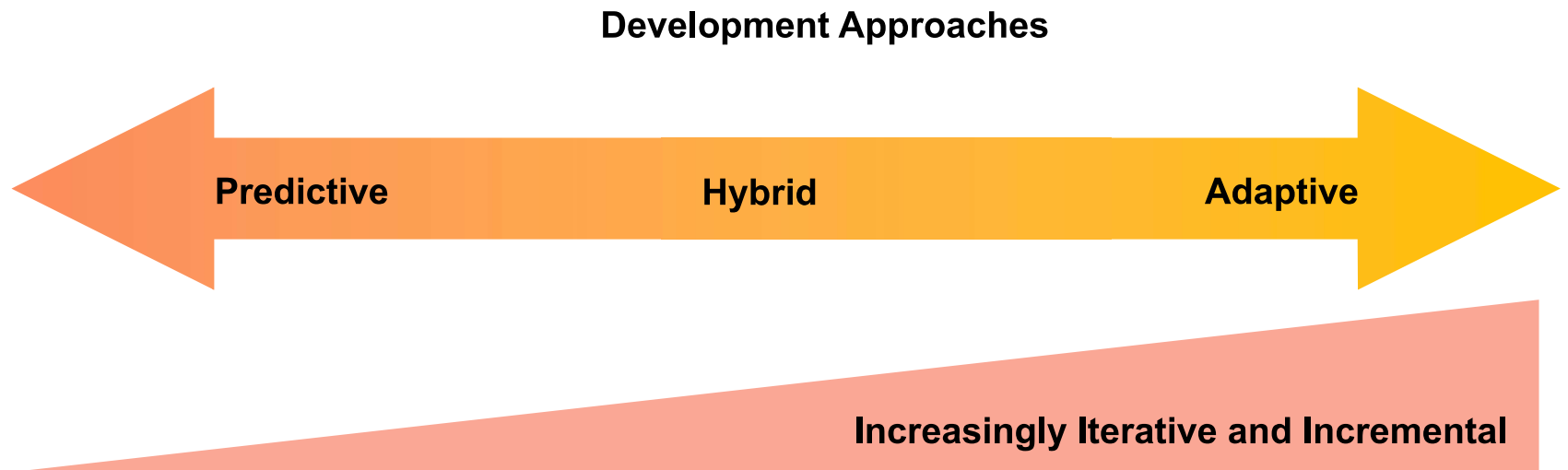

-
- Compatible with each other
 - Used in hybrid and adaptive projects
 - Break down development cycle to enable early value delivery

Iterative Way of Working: Video



Scrum



-
- This is a commonly used agile framework that offers suggestions for how work can be organized to maximize value to the end user.
 - Scrum is implemented at a product development team level.
 - Roles include a **scrum master/senior scrum master** who facilitates ceremonies (meetings); iterations are called **sprints**.



Remember that Agile frameworks focus on influencing the entire organization, including leadership and company culture.

Scrum Ceremonies Overview



-
- **Sprint planning**
 - Team collaborates with product owner to plan work for current sprint
 - Scrum master/senior scrum master facilitates
 - **Daily scrum**
 - Short, daily meeting of team only
 - Team members describe work, ask for help, consider progress toward goal
 - **Not** a status meeting
 - **Sprint review – can include Demo**
 - Held at end of sprint
 - Team, product owner and stakeholders attend, or customers review progress and give feedback to adapt product
 - **Sprint retrospective**
 - Team identifies improvements to performance and collaboration

Agile Ceremonies



We've discussed the ceremonies over the last few slides. Do you use them in your organization? How effective do they seem to be to you?

-
- **Product strategy meeting** – product owner shares product vision
 - **Daily standup or standup**
 - Team status meeting
 - 5 to 15 minutes, timeboxed
 - Not necessarily daily
 - **Backlog refinement**
 - Product owner prioritizes items on backlog
 - **Project retrospective**
 - Held at the end of a project to review work and processes
 - Like lessons learned

Product Ownership

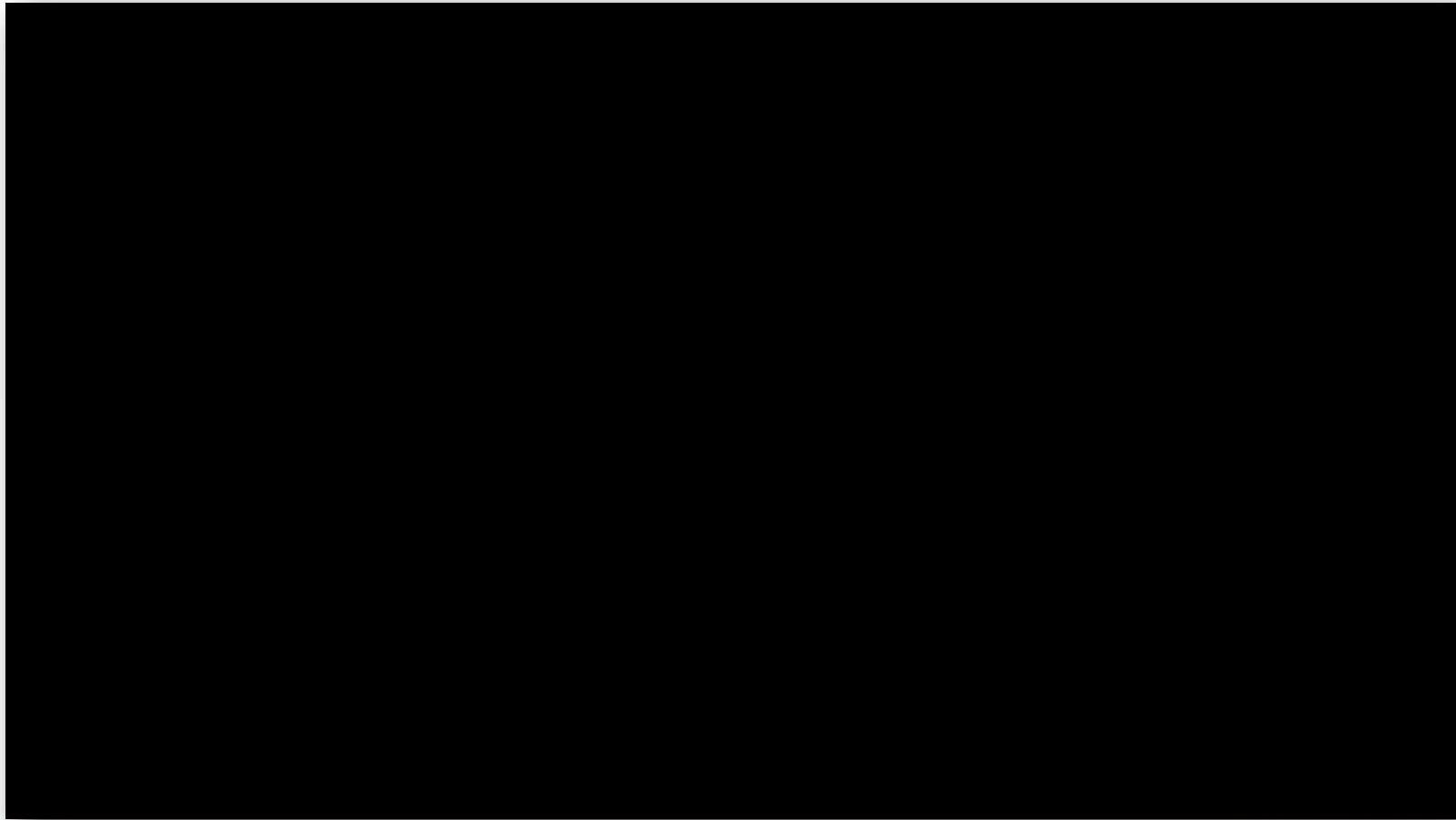

ECO Coverage

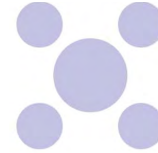

2.13 Determine appropriate project methodology/ methods and practices

- Assess project needs, complexity and magnitude (2.13.1)
- Recommend project execution strategy (e.g., contracting, financing) (2.13.2)
- Recommend a project methodology/approach (i.e., predictive, adaptive, hybrid) (2.13.3)

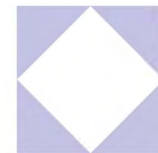
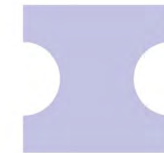
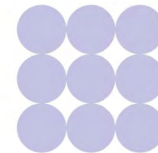
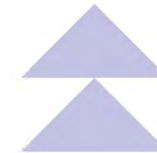

LESSON 3

PLAN THE PROJECT

- Planning Projects
- Scope
- Schedule
- Resources
- Budget
- Risks
- Quality
- Integrate Plans

Version 3.2 | 2023 Release



Learning Objectives

- Explain the importance of a project management plan.
- Provide an overview of scope planning in both predictive and adaptive projects.
- Provide an overview of schedule planning in both predictive and adaptive projects.
- Discuss resource planning for a project, including human and physical resources and the role of procurement.
- Determine the budgeting structure/method for a project
- Explain the importance of tailoring a budget.
- Identify strategies for dealing with risks and risk planning.
- Assemble a toolkit of possible responses to risks.
- Define quality and how it relates to the outcomes and deliveries for a project.
- Discuss the importance of integrating project management plans and tailoring a change management process.

Project Life Cycle Check-In

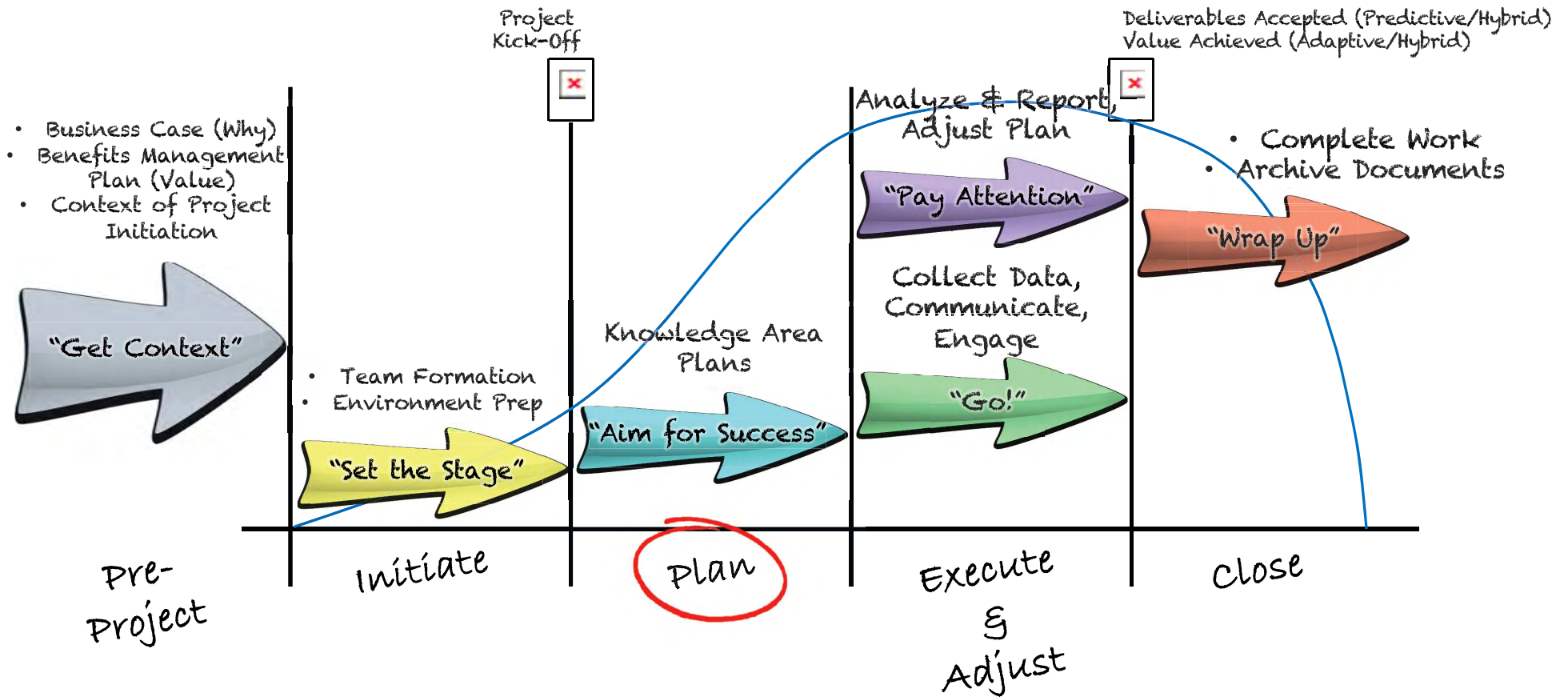



Planning Projects

TOPIC A

Planning Starts with a Project Management Plan

The document that describes how the project will be executed, monitored and controlled, and closed.

It includes:

- **Subsidiary plans**
- **Baselines**
- **Additional components**



Enables project managers to

- Execute
- Monitor
- Control
- Close

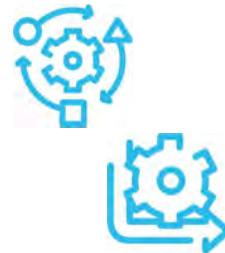

- Establishes guardrails to maintain controls, so
- Teams can tailor their way of working and act quickly and flexibly!



**See definition tab for list*

SUBSIDIARY MANAGEMENT PLANS

- Scope management plan
- Requirements management plan
- Schedule management plan
- Cost management plan
- Quality management plan
- Resource management plan
- Communications management plan
- Risk management plan
- Procurement management plan
- Stakeholder engagement plan

BASELINES

- Scope baseline
- Schedule baseline
- Cost baseline

ADDITIONAL COMPONENTS

- Change management plan
- Configuration management plan
- Performance measurement baseline
- Project life cycle
- Development approach
- Management reviews

ables project managers to

ecute

onitor

ontrol

ose

establishes guardrails to maintain controls,

....

ams can tailor their way of working and
t quickly and flexibly!

Project Documents*

Documentation and content created by the team to plan and manage the project effectively

Some documents are project **artifacts**, which need to be maintained and then archived at the end of the project.



They are not components of the project management plan.



*See definition tab for list

PROJECT DOCUMENTS

Any documents that are prepared in support of a project – for example, requirements, specifications, contracts with vendors, design documents, test plans, and publications that will be delivered to the client along with the final product.

1. Basis of estimates
2. Activity attributes
3. Activity list
4. Assumption log
5. Change log
6. Cost estimates
7. Cost forecasts
8. Duration estimates
9. Issue log
10. Lessons learned register
11. Milestone list
12. Physical resource assignments
13. Project calendars
14. Project communications
15. Project schedule
16. Project schedule network diagram
17. Project scope statement
18. Project team assignments
19. Quality control measurements
20. Quality metrics
21. Quality report
22. Requirements documentation
23. Requirements traceability matrix
24. Resource breakdown structure
25. Resource calendars
26. Resource requirements
27. Risk register
28. Risk report
29. Schedule data
30. Schedule forecasts
31. Stakeholder register
32. Team charter
33. Test and evaluation documents

in and manage the

be maintained and

ement plan.

Collaborative Planning

Adaptive and Hybrid Development Approaches





Product owner decides objectives according to customer needs/wants; team executes work and helps product owner **plan the work**



Team members are local domain experts in integration management — how **work will be planned** and completed

Project manager, team lead or scrum master helps focus the team to **execute the planned work**

Planning Across Life Cycles

	Predictive 	Hybrid 	Adaptive 
Requirements specification	Defined in specific terms before development	Elaborated periodically during delivery	Elaborated frequently during delivery
Outcome(s)	Delivered at the end of the project	Can be divided into pieces (incremental)	Delivered after each iteration according to stakeholder-desired value
Change	Constrained as much as possible	Incorporated at periodic intervals	Incorporated in real time during delivery
Stakeholder Involvement	At specific milestones	Regularly	Continuously
Risk and cost controls	Through detailed planning of mostly known consideration	Through progressive elaboration of plans	Done as requirements and constraints emerge

Topic Coverage

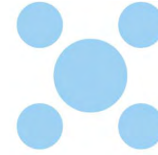

Differentiation of planning in predictive and adaptive approaches

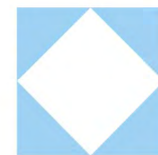
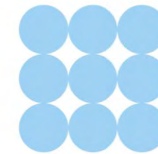



Scope

TOPIC B

Scope

- **Project scope** or **product scope**?
- Is it **fixed** or **flexible**?



Let's use the Shawpe Lifestyle Centre project—the independent case study part of this course—to understand these terms better.

Click me!



PROJECT
SCOPE

PRODUCT
SCOPE

FIXED

FLEXIBLE

PROJECT SCOPE

The features, functions, and works that characterize the delivery of a product, service, and/or result.

PRODUCT SCOPE

The functions and features that characterize a product or a service.

or **product**

flexible?



SHAWPE
INDUSTRIES

LIFESTYLE CENTRE

*Shawpe Lifestyle Centre
Independent case study
Case—to understand these*

PROJECT
SCOPE

The **project scope** of the Shawpe Lifestyle Centre is to complete a construction project and engage a sales and marketing project to fill it with tenants over time.

PRODUCT
SCOPE

The **product scope** is the completed revitalization of Oasestown with bespoke (customized) spaces for commercial and community tenants.

FIXED

The scope of the construction project is **fixed**. It's based on finalized blueprints and building compliance requirements with little room for change. . . and a specific timeline!

FLEXIBLE

The scope of the sales and marketing project is **flexible**. It depends on the timely completion of the construction project, market forces, and the customer's desired design. The team will derive as much **value** as possible, as early as possible, by working iteratively and incrementally.

Importance of Scope Planning!



Adaptability and Resilience in Planning

Rolling Wave Planning

- A form of **progressive elaboration** applied to work packages, planning packages and release planning
- Used in adaptive or predictive approaches



ROLLING WAVE PLANNING

An iterative planning technique in which the work to be accomplished in the near term is planned in detail, while the work in the future is planned at a higher level.

PROGRESSIVE ELABORATION

The iterative process of increasing the level of detail in a project management plan as greater amounts of information and more accurate estimates become available.

Planning

elaboration

, planning

Planning

Active



MVP or MBI?

Planning for
Work
Incrementally

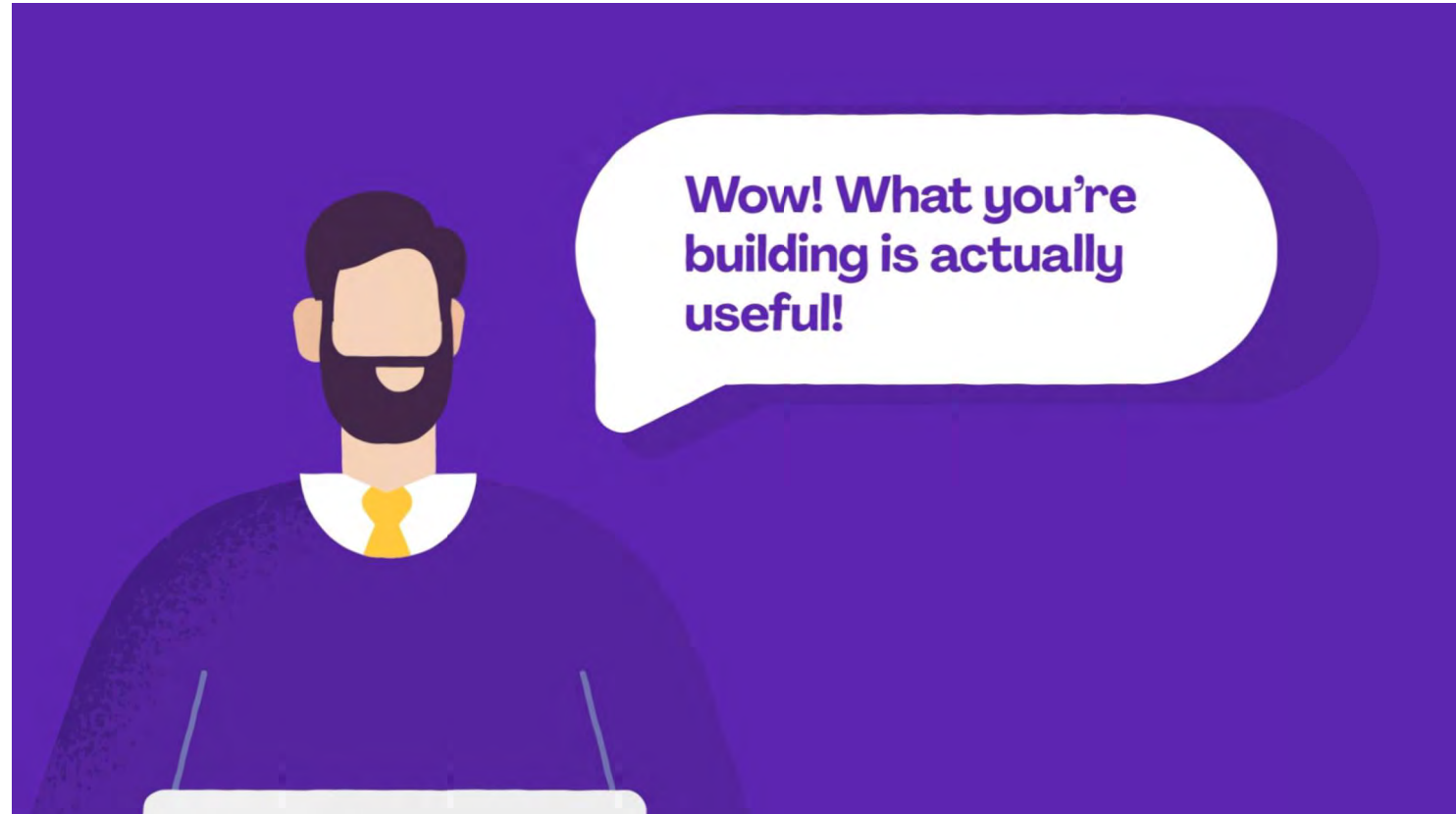

Product Roadmap*

- Envisions and plans the “big picture”
- Displays product strategy and direction and the value to be delivered
- Leads with the overarching product vision and uses progressive elaboration to refine vision
- Uses themes (goals) to provide structure and associations
- Provides short-term and long-term visualization

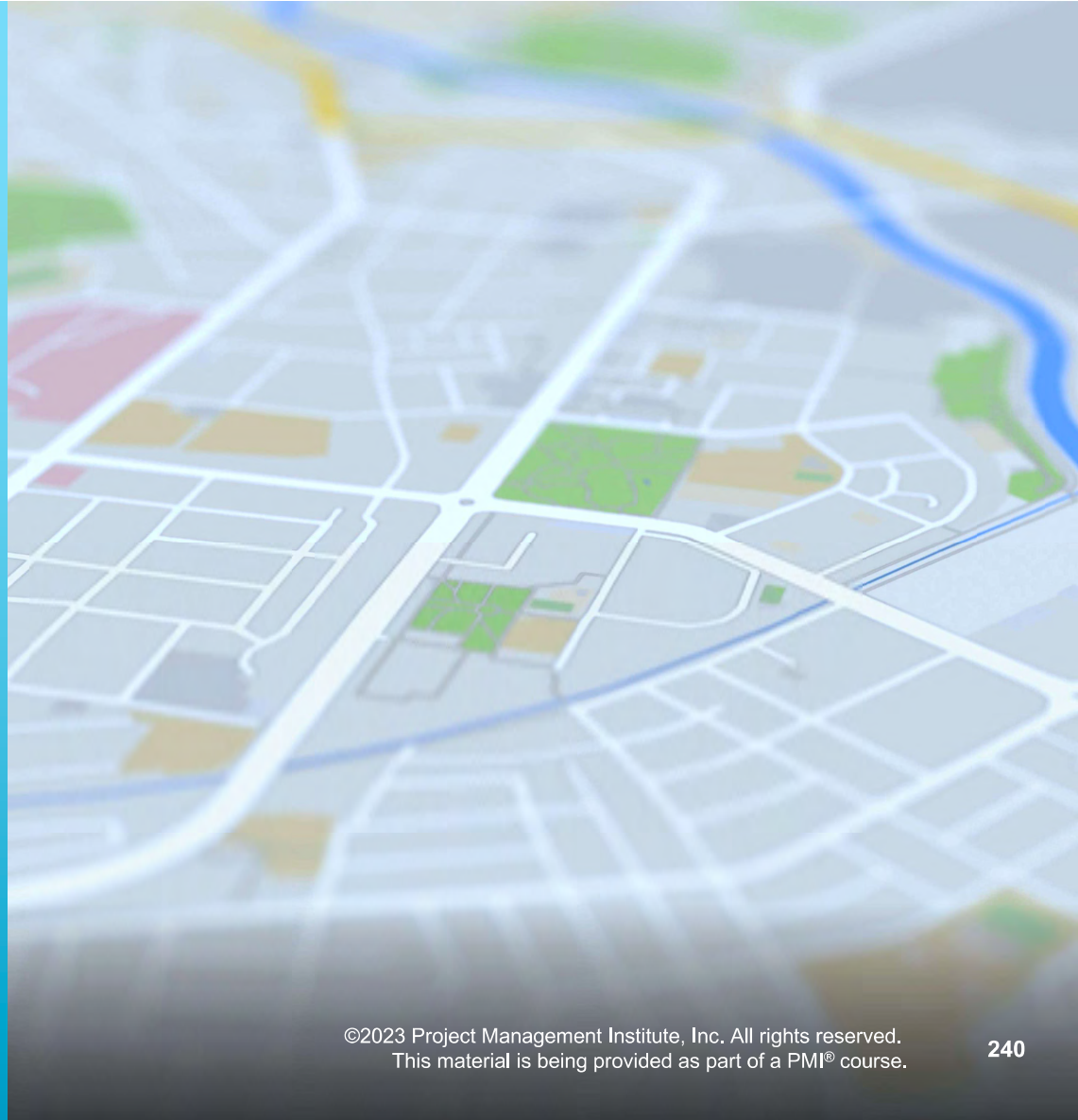

p*

“big picture”
and direction
ered
g product
ve elaboration
rovide structure
ong-term

PRODUCT ROADMAP

A high-level visual summary of the product or products of the project that includes goals, milestones, and potential deliverables



Milestones*

- **Markers** for big events, reviews, due dates, payments or decision-making
- **Prompts** for reporting requirements or sponsor/customer approval
- **Created by** project managers, customers or both

A **milestone list** identifies all milestones and indicates which are:

- Mandatory - required by contract, or
- Optional (estimated on historical information)



MILESTONE

A specific point within a project life cycle used as a measure in the progress toward the ultimate goal. A milestone marks a specific point along a project timeline. The point may signal anchors such as a project start and end date, a need for external review, or input and budget check. It is represented as a task of zero duration and is displayed as an important achievement in a project.

reviews, due
ion-making
quirements or
val
gers,
All milestones
contract, or
historical



Scope Planning

Comparison of Processes



PROJECT MANAGER

- Facilitates the **Collect Requirements Process**
- **Documents requirements** in a:
 - Scope statement (text/document)
 - Work breakdown structure (WBS) – (visual)
- Develops schedule, budget, resource and quality plans to deliver requirements



What might a hybrid scope planning process look like?



PRODUCT OWNER

- Creates and refines release backlog for iteration planning meeting
- Explains each prioritized **user story** in detail to the team

TEAM

- Estimates effort required and creates the iteration baseline, selecting stories to meet the expected velocity for the iteration.
- Places user stories from product backlog into release backlog to support identified features and functions
- Uses a story map to sequence and prioritize user stories in the release backlog

COLLECT REQUIREMENTS PROCESS

The process in which requirements documentation is developed. Precedes the Define Scope process.

REQUIREMENTS DOCUMENTATION

A description of how individual requirements meet the business need for the project.

USER STORY

An informal, general explanation of a product, service, or software feature written from the perspective of the end user. Its purpose is to articulate how the feature will provide value to the customer.

Processes

Requirements

Requirements in a:

Requirements Document)

Work Breakdown Structure (WBS) –

Project budget, resource and
Requirements

and scope planning



PRODUCT OWNER

- Creates and refines release backlog for iteration planning meeting
- Explains each prioritized **user story** in detail to the team

TEAM

- Estimates effort required and creates the iteration baseline, selecting stories to meet the expected velocity for the iteration.
- Places user stories from product backlog into release backlog to support identified features and functions
- Uses a story map to sequence and prioritize user stories in the release backlog

Get Started with Requirements?



 *Does this kind of project start with requirements?*

Click each button!



Yes!

In predictive projects, requirements are elicited and set at the beginning of the project.



Sort of...

User stories are a different way of thinking about the requirements process.



Maybe!

Hybrid projects may elicit and refine requirements or compose user stories.

Requirements

What Are They and Why Do We Need Them?



-
- A requirement is one single measurable statement of a condition or capability.
 - It tells how a product, service or result satisfies a business need.



Guidelines for use:

- *Start at a high level before providing details*
- *Must be unambiguous (measurable and testable), traceable, complete, consistent and acceptable to key stakeholders*

Document Requirements

- A simple format — e.g., a document listing all requirements, categorized by stakeholder and priority, OR
- More elaborate — e.g., executive summary, detailed descriptions, attachments
- **Requirements traceability matrix**



Requirements Traceability Matrix								
Project Name:								
Cost Center:								
Project Description:								
ID	Associate ID	Requirements Description	Business Needs, Opportunities, Goals, Objectives	Project Objectives	WBS Deliverables	Product Design	Product Development	Test Cases
001	1.0							
	1.1							
	1.2							
	1.2.1							
002	2.0							
	2.1							
	2.1.1							
003	3.0							
	3.1							
	3.2							
004	4.0							
005	5.0							

Requirements Management Plan

Plan, Track and Report on Requirements Activities



-
- Configuration management activities:
 - Version control rules
 - Impact analysis - tracing, tracking and reporting
 - Required authorization levels for change approval
 - Prioritization criteria/process
 - Product metrics and accompanying rationale
 - Traceability structure, including requirement attributes

Types of Requirements

Type	Describes the...
Project	Actions, processes and conditions the project must meet
Product	Features and characteristics of the product, service or result that will meet the business and stakeholder requirements <ul style="list-style-type: none"> • Functional – Product features • Nonfunctional - Supplemental environmental conditions/qualities that make the product effective
Quality	Conditions or criteria needed to validate the successful completion of a project deliverable or fulfilment of other project requirements
Business	Higher-level organizational needs, reasons for the project
Stakeholder	Stakeholder (or stakeholder group) needs —aka “Reporting requirements”
Transition/ Readiness	Temporary capabilities needed to transition successfully to the desired future state

Collect Requirements Process

- **Expert Judgment**
- **Interpersonal/Team Skills**
 - **Nominal group technique**
 - Observation
 - Facilitation
- **Data Gathering**
 - Brainstorming
 - Interviews
 - Focus groups
 - Questionnaires and surveys
 - Benchmarking
- **Data Analysis**
 - Document analysis
 - Alternatives analysis
 - Product analysis (if deliverable is a product)
- **Decision-Making Techniques**
 - Voting
 - **Multi-criteria decision analysis**
- **Data Representation**
 - Mind mapping
 - Affinity diagram
 - Context or use case diagram
- **Prototyping** — e.g., **storyboarding**



NOMINAL GROUP TECHNIQUE

A technique that enhances brainstorming with a voting process used to rank the most useful ideas for further brainstorming or for prioritization.

MULTI-CRITERIA DECISION ANALYSIS

A technique that utilizes a decision matrix to provide a systematic, analytical approach for establishing criteria, such as risk levels, uncertainty, and valuation, to evaluate and rank many ideas.

- **Expert Judgment**
- **Interpersonal/Team Skills**
 - **Nominal group technique**
 - Observation
 - Facilitation
- **Data Gathering**
 - Brainstorming
 - Interviews
 - Focus groups
 - Questionnaires and surveys
 - Benchmarking
- **Data Analysis**
 - Document analysis
 - Alternatives analysis
 - Product analysis (if deliverable is a product)
- **Decision-Making Techniques**
 - Voting
 - **Multi-criteria decision analysis**
- **Data Representation**
 - Mind mapping
 - Affinity diagram
 - Context or use case diagram
- **Prototyping — e.g., storyboarding**

Scope Planning: How to Collect Requirements



	Interviews	Questionnaires/Surveys	Observations	Focus Groups	Facilitated Workshops
Characteristics	<ul style="list-style-type: none"> Identify/define features and functions of deliverables Can be structured, unstructured or asynchronous 	<ul style="list-style-type: none"> Written format Captures information from large groups Yields quantitative data 	<ul style="list-style-type: none"> Physical technique used learn about a specific job role, task or function 	<ul style="list-style-type: none"> Casual/interactive information-sharing Moderator-guided Includes stakeholders and SMEs Yields qualitative data 	<ul style="list-style-type: none"> Sessions organized by project managers to determine requirements and enable stakeholder agreement on project outcomes
Advantages	<ul style="list-style-type: none"> Handles sensitive/confidential information Helps identify stakeholder requirements, goals or expectations 	<ul style="list-style-type: none"> Quick turnaround Effective with varied and geographically dispersed respondents Yields quantifiable data for statistical analysis 	<ul style="list-style-type: none"> Team can understand where changes might be beneficial 	<ul style="list-style-type: none"> Pre-selected participants for varied opinions Small group for focused approach and gathering specific information 	<ul style="list-style-type: none"> Team can capture requirements Stakeholders can understand the concerns and requirements of others
Considerations (potential drawbacks)	<ul style="list-style-type: none"> Captures only a single point of view 	<ul style="list-style-type: none"> Time consuming Answer/ data quality depends on question quality 		<ul style="list-style-type: none"> Must prequalify stakeholders SMEs and facilitation are essential 	<ul style="list-style-type: none"> Facilitation is essential

Data Gathering

Use **Benchmarks** to generate product requirements

- Requires best practices to make comparisons
- Evaluates and compares an organization's or project's practices with others
- Identifies best practices in order to meet or exceed them



- *Can you remember the other methods for data gathering?*
- *Why do you think benchmarking is effective in gathering data for scope planning?*
- *Why would you choose it instead of the other methods?*



BENCHMARKING

The comparison of actual or planned products, processes, and practices to those of comparable organizations to identify best practices, generate ideas for improvement, and provide a basis for measuring performance.

Use **Benchmarks** to generate product requirements

- Requires best practices to make comparisons
- Evaluates and compares an organization's or project's practices with others
- Identifies best practices in order to meet or exceed them



- *Can you remember the other methods for data gathering?*
- *Why do you think benchmarking is effective in gathering data for scope planning?*
- *Why would you choose it instead of the other methods?*

Scope Planning – Requirements Prioritization



Tool or Technique	Description	Benefits
MoSCoW Analysis <i>developed by Dai Clegg</i>	Used to reach a common understanding with stakeholders on the importance of each requirement. They indicate: <ul style="list-style-type: none"> • M - Must have • S - Should have • C - Could have • W - Won't have (for now) 	<ul style="list-style-type: none"> • Compares several points of view • Used with timeboxing to focus on the most important requirements • Common in agile software development, Scrum, RAD and DSDM
Kano Model <i>(Product management technique)</i> <i>developed by Noriaki Kano</i>	Understand and classify all potential customer requirements or features into four categories of need: <ul style="list-style-type: none"> • Delighters/exciters • Satisfiers • Dissatisfiers • Indifferent 	<ul style="list-style-type: none"> • Development efforts can then be prioritized by the things that most influence customer satisfaction and loyalty.
Paired Comparison Analysis <i>developed by LL Thurston</i>	Rate and rank alternatives by comparing one against the other	<ul style="list-style-type: none"> • Good for small range of subjective requirements
100 Points Method (aka fixed sum or fixed allocation method) <i>developed by Dean Leffingwell and Don Widrig</i>	Vote for importance of requirements in a list; stakeholders distribute 100 points in any way they wish (Like “Monopoly money” method)	<ul style="list-style-type: none"> • Good for any size group, even large ones • Gives priority to stakeholder decision- making because they must exercise depth of thought

Represent Data

- **Mind Mapping** – Consolidate ideas created through individual brainstorming sessions into a single map to reflect commonality and differences in understanding and to generate new ideas
- **Affinity Diagram** – Allows large numbers of ideas to be classified for review and analysis



Context Diagrams*



Business Context Diagram Example

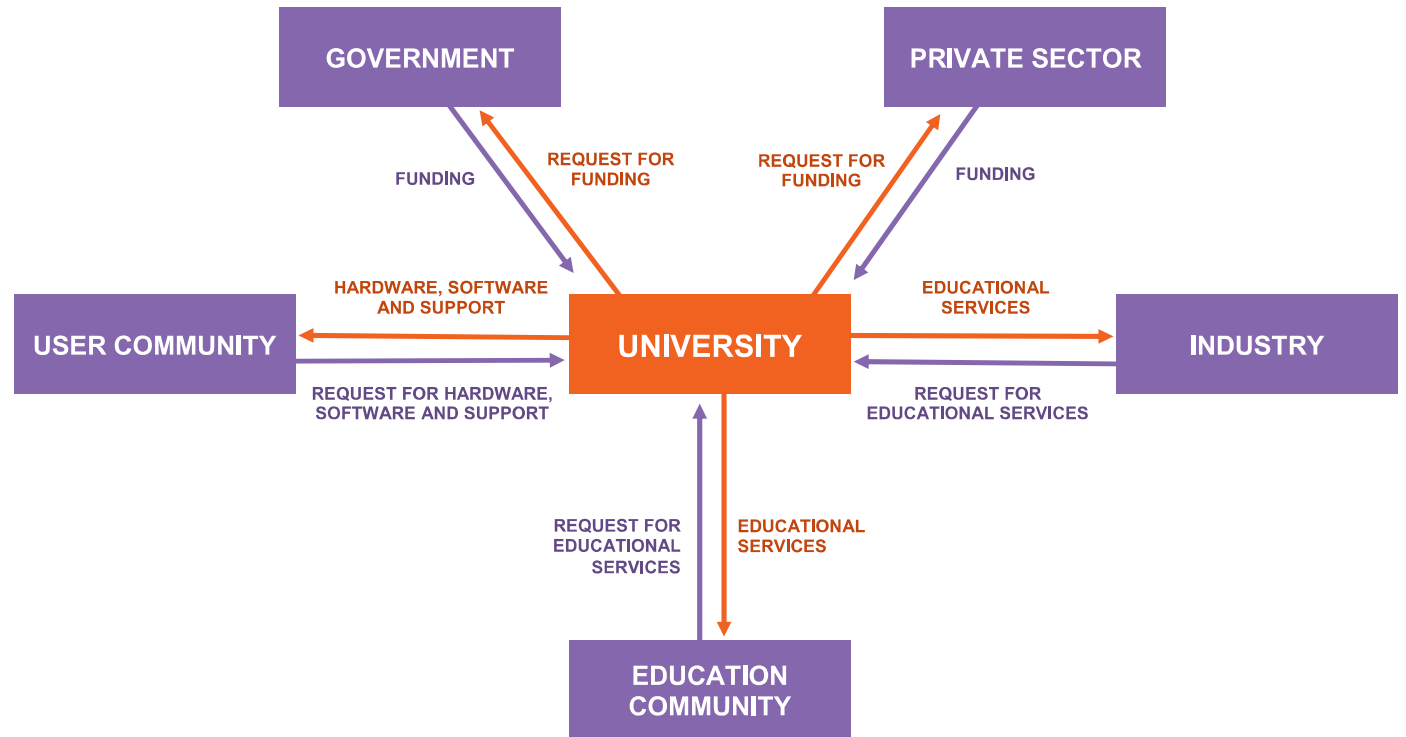



Business Context Diagram Example

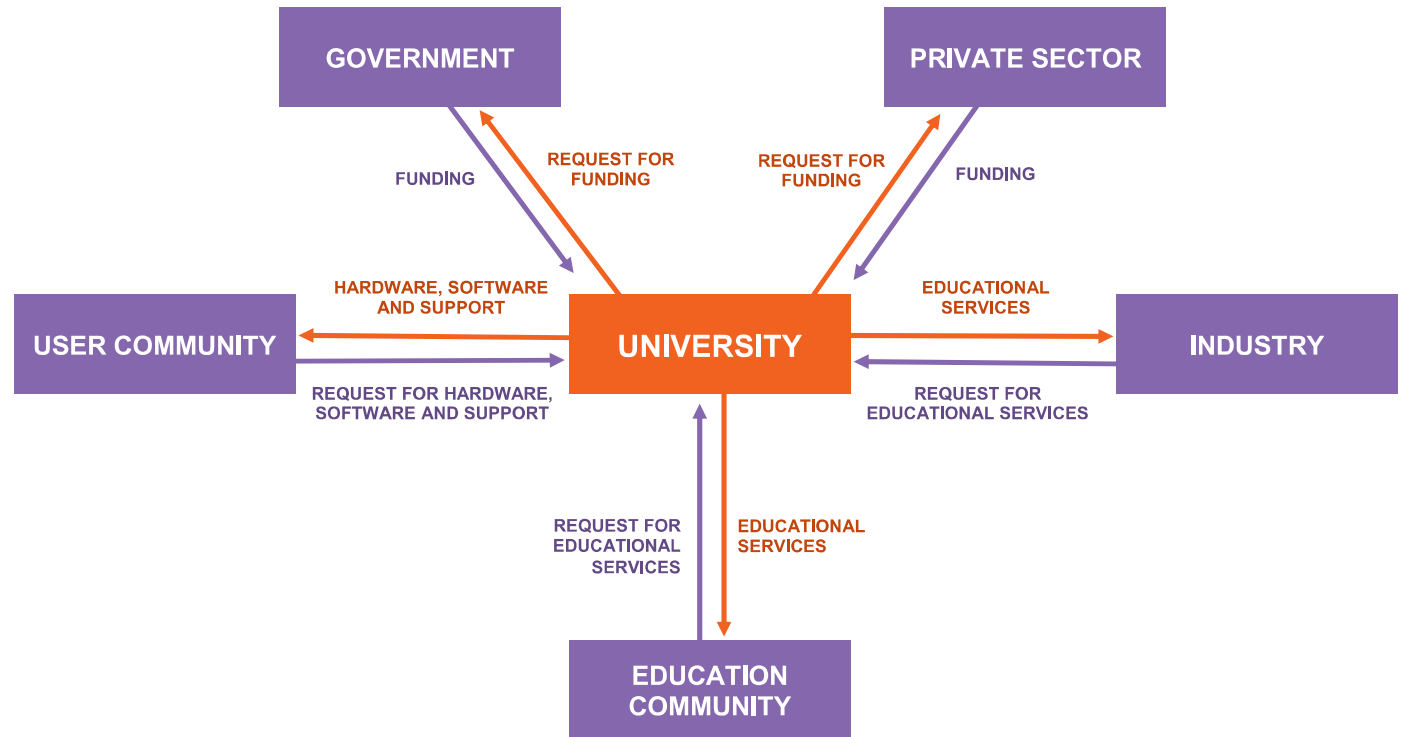

CONTEXT DIAGRAM

Visual depiction of product scope, showing a business system (process, equipment, computer system, etc.) and how people and other systems interact with it.

Prototyping

- **Evaluation** and **experimentation** tool
- Enables early feedback for further development and **to develop a detailed list of project requirements**
- **Storyboarding** is a type of **prototyping** that uses visuals or images to illustrate a process or represent a project outcome.



STORYBOARDING

The prototyping method that uses visuals or images to illustrate a process or represent a project outcome. Storyboards are useful to illustrate how a product, service, or application will function or operate when it is complete.

PROTOTYPES

A method of obtaining early feedback on user requirements by building a working model of the expected product. Prototypes can be used to solicit aesthetics, functionalities etc. Several iterations maybe displayed.

o.n tool
er
detailed

otyping
ustrate a
outcome.



Scope Management Plan*

-
- Review of the scope activities for the project and how that work will be done
 - Should include processes to prepare a project scope statement
 - Enables the creation of the WBS from the detailed project scope statement
 - Establishes how the **scope baseline** will be approved and maintained
 - Specifies how **formal acceptance** of the completed project deliverables will be obtained
 - Can be formal or informal, broadly framed or highly detailed



SCOPE MANAGEMENT PLAN

A component of the project or program management plan that describes how the scope will be defined, developed, monitored, controlled, and validated.

- Review of the scope activities for the project and how that work will be done
- Should include processes to prepare a project scope statement
- Enables the creation of the WBS from the detailed project scope statement
- Establishes how the **scope baseline** will be approved and maintained
- Specifies how **formal acceptance** of the completed project deliverables will be obtained
- Can be formal or informal, broadly framed or highly detailed

Project Scope Statement



Includes –

- Scope description - project and product
- Acceptance criteria
- Any required deliverables
- Any out-of-scope items needed for clarification
- Constraints and assumptions



Once it has been approved and baselined, changes are only permitted in accordance with the change management plan.

Scope Planning

Tools and Techniques for Analysis

 Match the requirements analysis tool/technique with the correct description.



Document analysis

Used to consider possible potential options or approaches to execute and perform project work

Alternatives analysis

Analyze the information needed to develop the project scope statement or any technical detail

Product analysis

Derive new project requirements from existing documents

Expert judgment

Ask questions about a product and form answers to describe use, characteristics, and other relevant aspects

Scope Planning

Tools and Techniques for Analysis

Match the requirements analysis tool/technique with the correct description.



Document analysis

Used to consider possible potential options or approaches to execute and perform project work

Alternatives analysis

Analyze the information needed to develop the project scope statement or any technical detail

Product analysis

Derive new project requirements from existing documents

Expert judgment

Ask questions about a product and form answers to describe use, characteristics, and other relevant aspects

Product Analysis Methods



PRODUCT BREAKDOWN

Splits a product and its requirements into components to achieve a clear understanding of work

SYSTEMS ENGINEERING

Approaches design, integration, and management, and the life cycle of complex systems in a multi-disciplinary way

SYSTEMS ANALYSIS

Studies a product /service to identify its goals and purposes and create systems/ procedures to achieve them efficiently

REQUIREMENTS ANALYSIS

Identifies, validates and documents specifications for projects

VALUE ENGINEERING

Optimizes value in a structured way

VALUE ANALYSIS

Examines factors affecting product/service cost in a systematic, interdisciplinary way towards success with the lowest cost and required quality and reliability standards

Create the Work Breakdown Structure (WBS)*

- Follow the 100% rule!
 - Include every aspect – nothing extra, nothing missing
- Include project and product components
- Use hierarchical structure
 - Highest – project
 - Next – deliverables
 - Lowest – work package

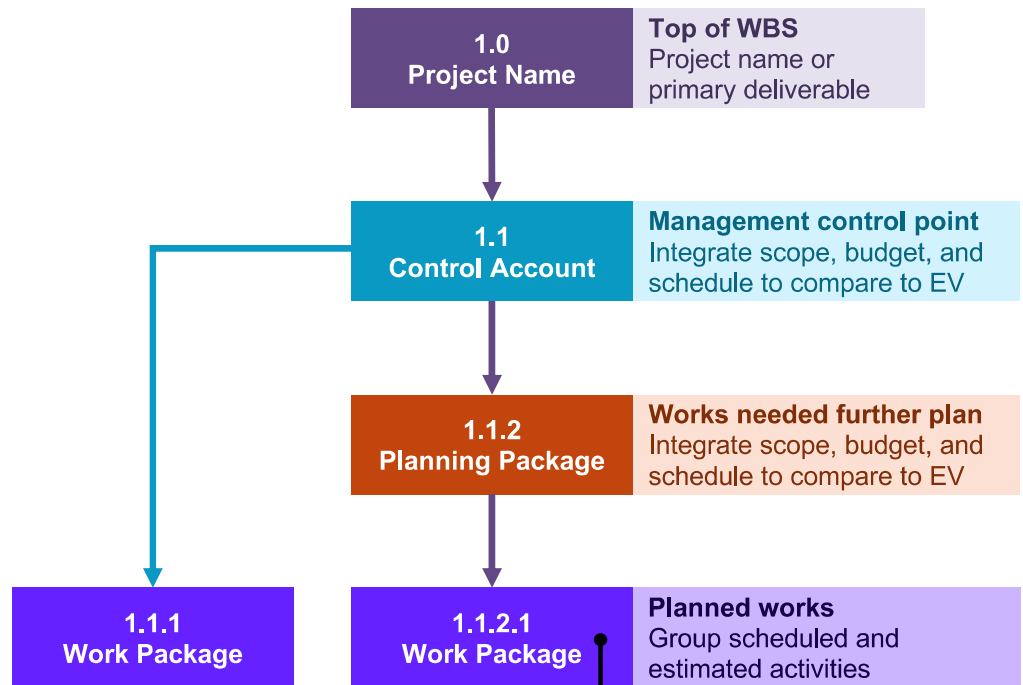

Each work package is part of only one financial control account.

Breakdown

nothing extra,
components

WORK BREAKDOWN STRUCTURE (WBS)

A hierarchical decomposition of the total scope of work to be carried out by the project team to accomplish the project objectives and create the required deliverables.

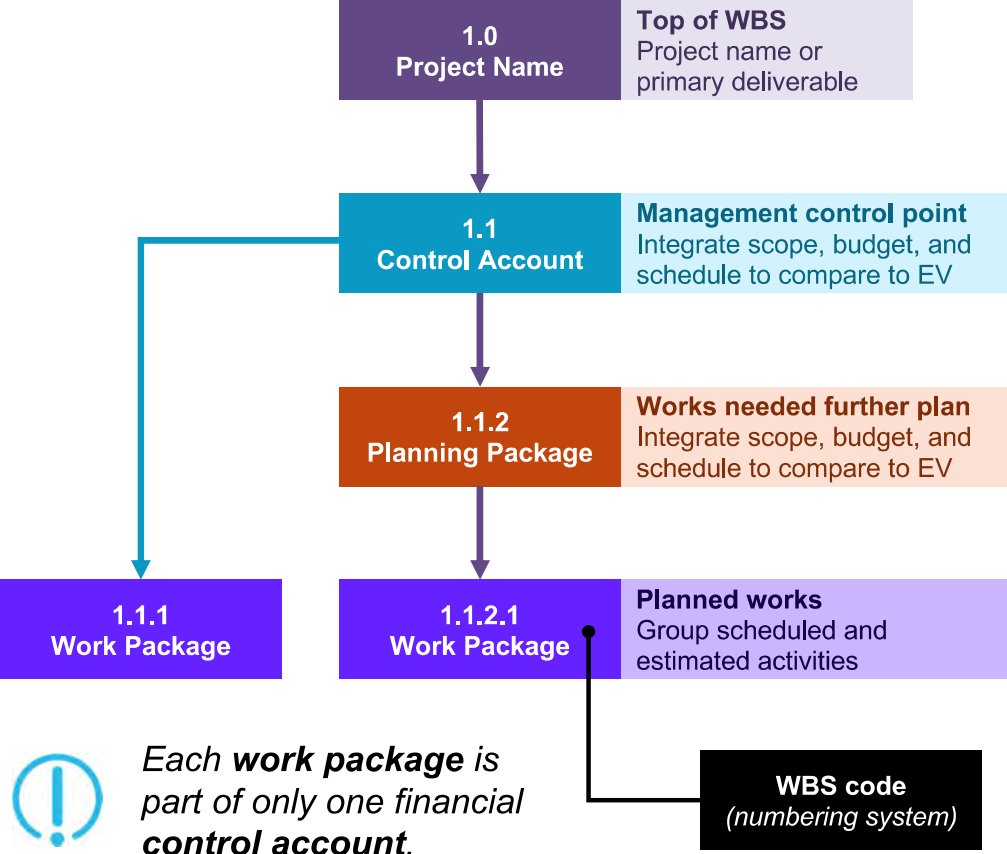

Decompose Work in the WBS

Divide and subdivide the project scope and deliverables into smaller, more manageable parts



Steps:

1. Identify deliverables and the work/tasks needed to accomplish them
2. Structure and organize the WBS
3. Decompose high-level WBS scope components into low-level components
4. Develop and assign a unique identification code to each component from the **code of accounts**
5. Review the decomposition of work packages and verify that they align with the project requirements



Tailor the level of decomposition to specific project needs and the level of granularity needed to manage the project effectively.

WBS Dictionary

Provides detailed deliverable, activity and scheduling information about each component in the WBS



Decompose work and include:

- WBS code identifier
- Description of work
- Assumptions and constraints
- Responsible organization
- Schedule **milestones**
- Associated schedule activities
- Resources required to complete the work
- Cost estimations
- Quality requirements
- **Acceptance criteria**
- Technical references
- Agreement information

Scope Baseline



-
- Approved version of a scope statement, WBS and its associated WBS dictionary, that can be changed only using formal change control procedures
 - Used as a basis for comparison to actual results

Components include:

- Project scope statement
- WBS
- Work packages
- Planning package
- WBS dictionary

Don't Forget to Plan for Transitions / Handovers!



Include activities to fulfill transition/implementation in the scope of work

- Consider all stakeholders, schedules, risks, budgets, and quality standards.
- Identify deliverables/outputs



These can be delivered throughout the project, not just at the end!

Questions to consider:

- Will the work be new, or an update in the business environment?
- How best to transition the product into a live environment?
- What about decommissioning or removing old systems, processes or materials?
- Did you ensure training and knowledge transfer are complete/satisfactory?



How do adaptive or hybrid teams “plan” for handovers or transitions?

Scope Planning in Adaptive Environments

- Incremental or iterative development
- User stories propose an alternative way of viewing the requirements process

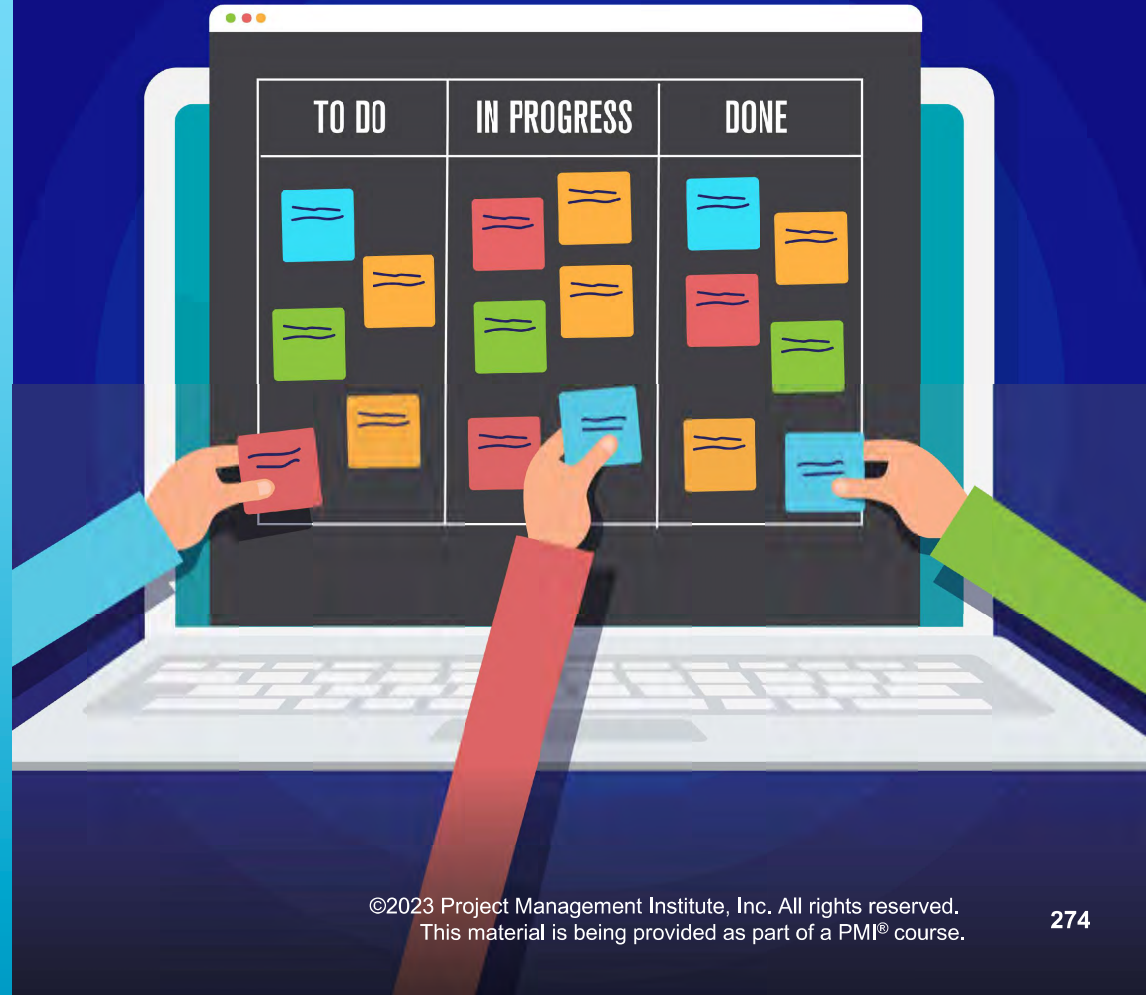

Release and Iteration Planning



Planning also takes place at the standup meeting when teams discuss details of work in progress.



Collaborative planning meetings that break scope into larger releases and then iterations/sprints

At **release planning** (or Agile release planning), decide:

- Number of iterations or sprints needed to complete each release
- Features contained in the release
- Goal dates of each release

At **iteration planning** (or sprint planning):

- Review the highest prioritized user stories or key outcomes
- Ask questions
- Agree on effort required to complete the user story in the current iteration
- Determine the activities required to deliver iteration objectives

Backlogs

- Prioritized list of **the known scope of work**
- Information presented in **story form**
- Continually updated by the **product owner in collaboration with teams**



Example:

A **product owner** creates a **product backlog** and identifies and adds stories in collaboration with the team and stakeholders. Work items describe desired product functionality through user stories.

- The product owner is responsible for prioritizing work according to value.
- The product owner and team collaborate to move work items to the **iteration/sprint backlog**.



Backlogs may be known by slightly different names on your team or project, but the names are generally descriptive — e.g., requirements backlog, sprint backlog, lean backlog.

User Stories, Story Maps, Roadmaps

- A **story map** organizes **user stories** into functional groups and within a narrative flow (“the big picture”) of the **product roadmap**.
- Helpful for discovering, envisioning and prioritizing the product and a way ahead!
- *Story map technique developed by Jeff Patton*

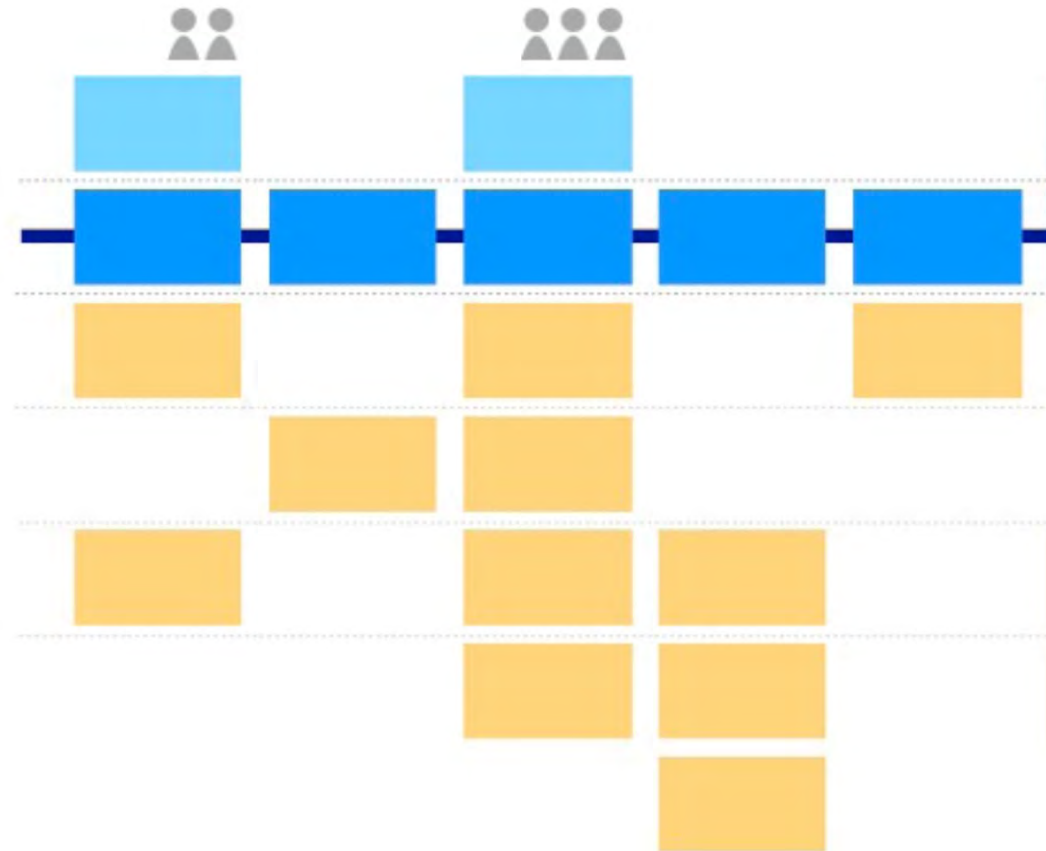

Epics > Features > User Stories

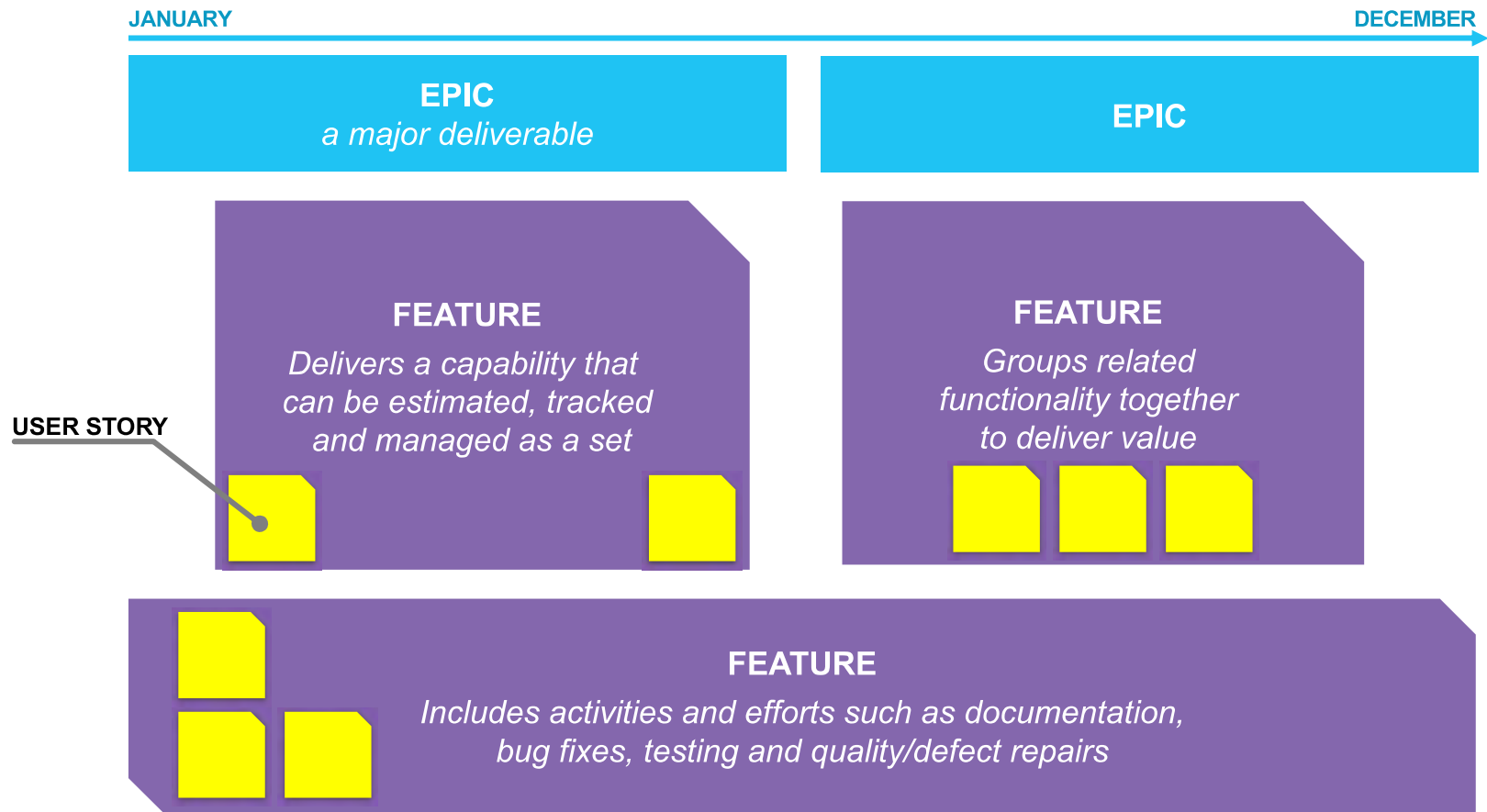

Features > User Stories

DECEMBER

EPIC

A large body of work that can be broken down into smaller pieces—features and user stories. Epics can take months to complete.



FEATURE

A set of related requirements that allows the user to satisfy a business objective or need.

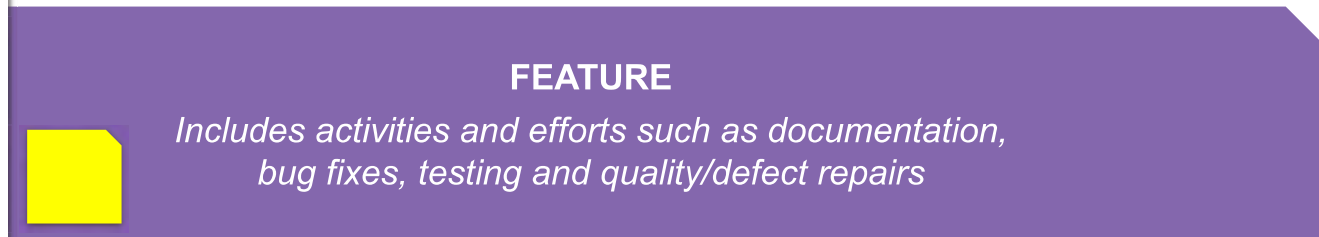
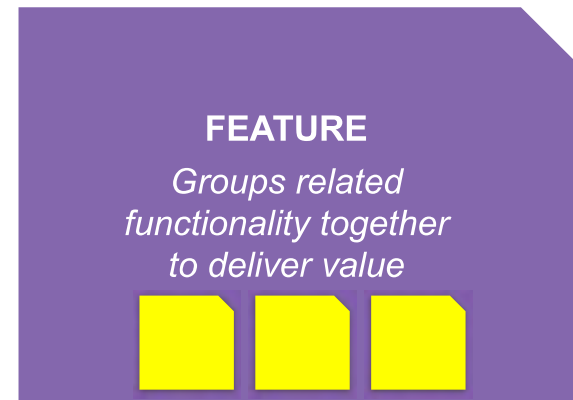
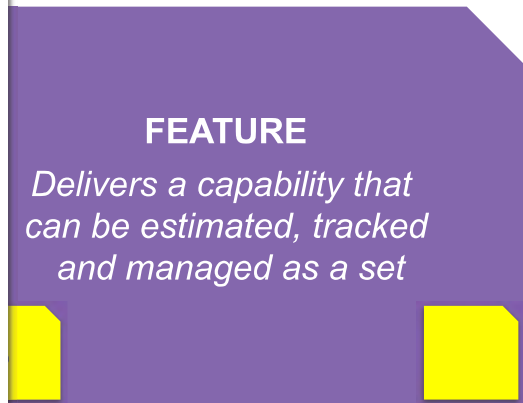

Prioritize and Refine the Backlog



-
- Continual refinement done by product owner/customer prior to iteration planning
 - Additional refinement can be done jointly by the team and product owner during the sprint/iteration
 - Allows reorganization and reprioritization of work to complete higher-priority items that deliver value first
 - Split epics into user stories

Plan Scope: Quiz

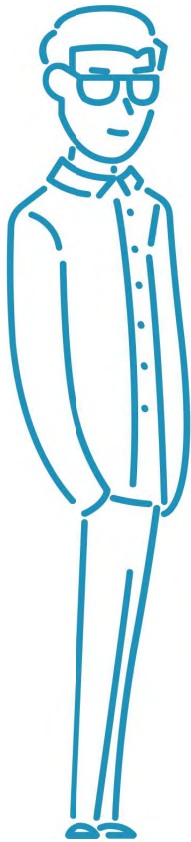

Which two stakeholders perform project scope planning? (*Choose two*)

- a. Ang Fen, project manager
- b. Helen Grey, product owner
- c. Eugene Lowe, project sponsor
- d. Project team

Ang Fen wants to give the executive team an overview of the work ahead at the next strategy meeting. Which artifact should he show them?

- a. Scope management plan
- b. Product roadmap
- c. Scope statement
- d. Work breakdown structure



Plan Scope: Quiz

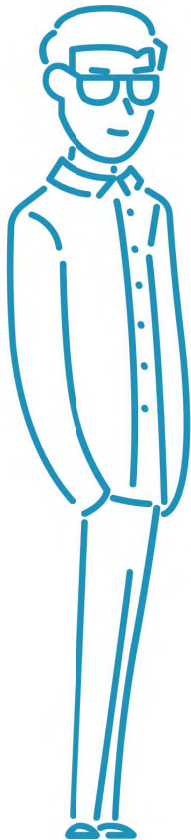

Which two stakeholders perform project scope planning? (*Choose two*)

- a. Ang Fen, project manager
 - ~~b. Helen Grey, product owner~~
 - ~~c. Eugene Lowe, project sponsor~~
 - d. Project team
-

Ang Fen wants to give the executive team an overview of the work ahead at the next strategy meeting. Which artifact should he show them?

- ~~a. Scope management plan~~
- b. Product roadmap
- ~~c. Scope statement~~
- ~~d. Work breakdown structure~~



ECO Coverage

2.1 Execute project with the urgency required to deliver business value

- Support the team to subdivide Project tasks as necessary to find the minimum viable product (2.1.3)

2.8 Plan and manage scope

- Predictive vs Adaptive approach for scope
- Determine and prioritize requirements (2.8.1)
- Break down scope (e.g., WBS, backlog) (2.8.2)

2.17 Plan and manage project/phase closure or transitions

- Determine criteria to successfully close the project or phase (2.17.1)

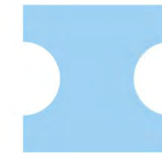
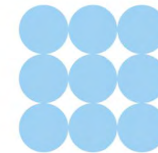
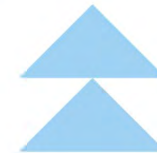
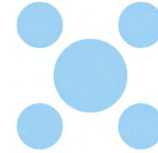



Schedule

TOPIC C

Get from “A” to “B”

Overview of Schedule Planning Processes



The project manager ensures that:

- Work package is broken down into required activities
- Dependencies and precedence relationships are determined
- Activity durations are estimated based on average resources
- Critical path is determined
- Resource overallocations are resolved
- Schedule is compressed to meet any constraints



The project team:

- Uses either a time boxed (cadences) or continuous flow method
- Adopts release time frames
- Plans each iteration with work
- Prioritizes, estimates and decomposes user stories into tasks and determines iteration velocity
- *Works with product owner* to refine the backlog after each iteration and plan the next

Schedule Management Plan*

- Describes how activities will be defined and progressively elaborated
- Identifies scheduling method and scheduling tool used
- Determines schedule format
- Establishes criteria for developing and controlling the schedule
- May be tailored for use in any type of project
- Defines the maintenance process for updating status and records project progress in the schedule model during execution



In hybrid approaches, a schedule management plan can help by placing management controls on the project time line.



SCHEDULE MANAGEMENT PLAN

A component of the project or program management plan that establishes the criteria and activities for developing, monitoring, and controlling the schedule.

-
- Describes how activities will be defined and progressively elaborated
 - Identifies scheduling method and scheduling tool used
 - Determines schedule format
 - Establishes criteria for developing and controlling the schedule
 - May be tailored for use in any type of project
 - Defines the maintenance process for updating status and records project progress in the schedule model during execution



In hybrid approaches, a schedule management plan can help by placing management controls on the project time line.

Schedule Management Plan Components



Discuss how the schedule management plan can be a beneficial tool in hybrid projects. Who would it benefit?

Project schedule model

- Methodology/tool for schedule development
- Includes maintenance planning, including status updates and progress during execution

Accuracy

- Acceptable range used to determine realistic activity duration estimates
- May include risk contingency

Units of measure

Defined for each resource – e.g., staff hours, days and weeks

Organizational procedural links

Use of WBS to ensure consistency with estimates and schedules

Control thresholds

- For monitoring schedule performance before taking action – e.g., escalation/reviews
- Expressed as percentage deviations from the baseline — e.g., percent ahead or behind schedule

Rules

Performance measurement — e.g., earned value management (EVM) rules

Reporting

Frequency and formats for schedule-related reports

Process descriptions

Describes how schedule management processes are documented

Start with Benchmarks and Historical Data

Benchmarking

- Compares current project schedule with a similar product/service schedule
- Provides a good “starting point” for estimation before detailed analysis
- Assesses feasibility in the initial stage of scheduling

Historical data

Learn lessons from completed projects in the organization

Hybrid Schedules

Example Characteristics and Benefits



-
- Tailored plans to combine consistency and management oversight with flexible scheduling of work
 - Better product/deliverable quality with incremental or short-term value delivery and change (improvements, fixes) incorporated at intervals
 - Product delivery can be divided into subsets according to a plan (milestone or cadence)

Predictive Schedule Planning

The project manager:

- Breaks down a **work package** into the required activities
- Determines **dependencies** and **precedence relationships**
- Estimates the duration of activities based on average resources
- Determines the **critical path**
- Resolves resource overallocations
- Compresses the schedule, if needed, to meet constraints



WORK PACKAGE

The work defined at the lowest level of the work breakdown structure (WBS) for which cost, and duration are estimated and managed.

DEPENDENCY

A relationship between one or more tasks/activities. A dependency may be mandatory or discretionary, internal or external. See also “start-to-start”; “start-to-finish”; “finish-to-start”; and “finish-to-finish”.

PRECEDENCE RELATIONSHIP

A logical dependency used in the precedence diagramming methods.

CRITICAL PATH

The sequence of activities that represents the longest path through a project, which determines the shortest possible duration.

ager:

work package into the required activities

dependencies and precedence relationships

duration of activities based on average resources

critical path

resource overallocations

the schedule, if needed, to meet constraints

Break Down Project Activities*

- Break down project work packages into activities (noun)
- Enter activities into the **activity list** using a verb statement
- Use the **activity list** to develop the project schedule
- Include duration (start and end day) for every activity

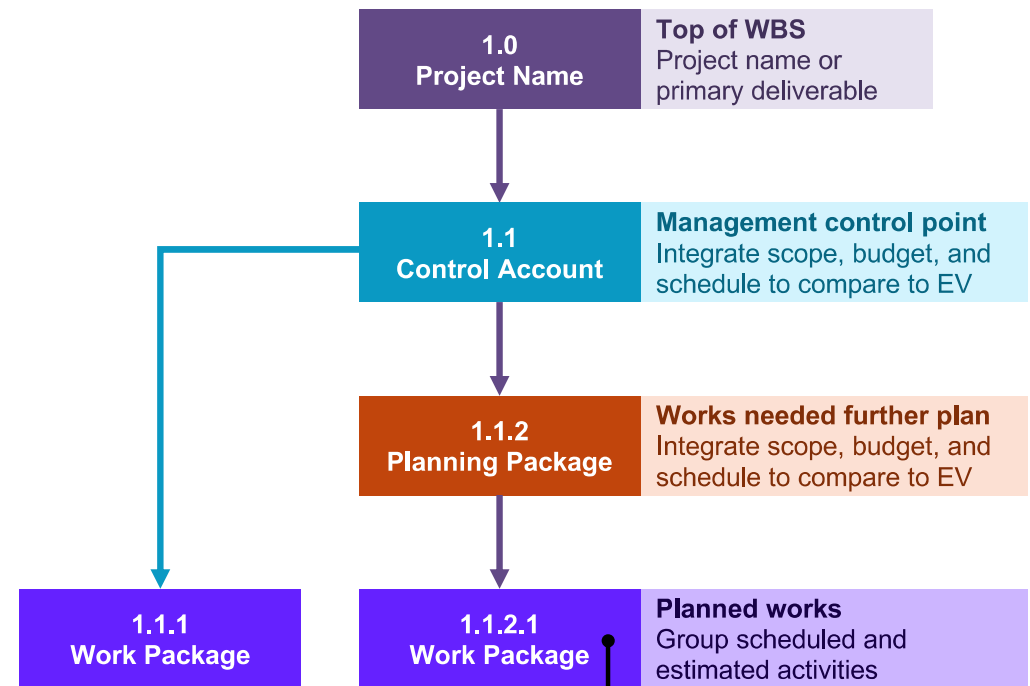

Tailor the amount of detail in activities to the project context to enable meaningful estimation and planning.

ect

ackages into

ity list using a

op the project

nd day) for every

PROJECT ACTIVITY

A distinct, scheduled portion of work performed during a project.

ACTIVITY LIST

A documented tabulation of schedule activities that shows the activity description, activity identifier, and a sufficiently detailed scope-of-work description so project team members understand what work is to be performed.

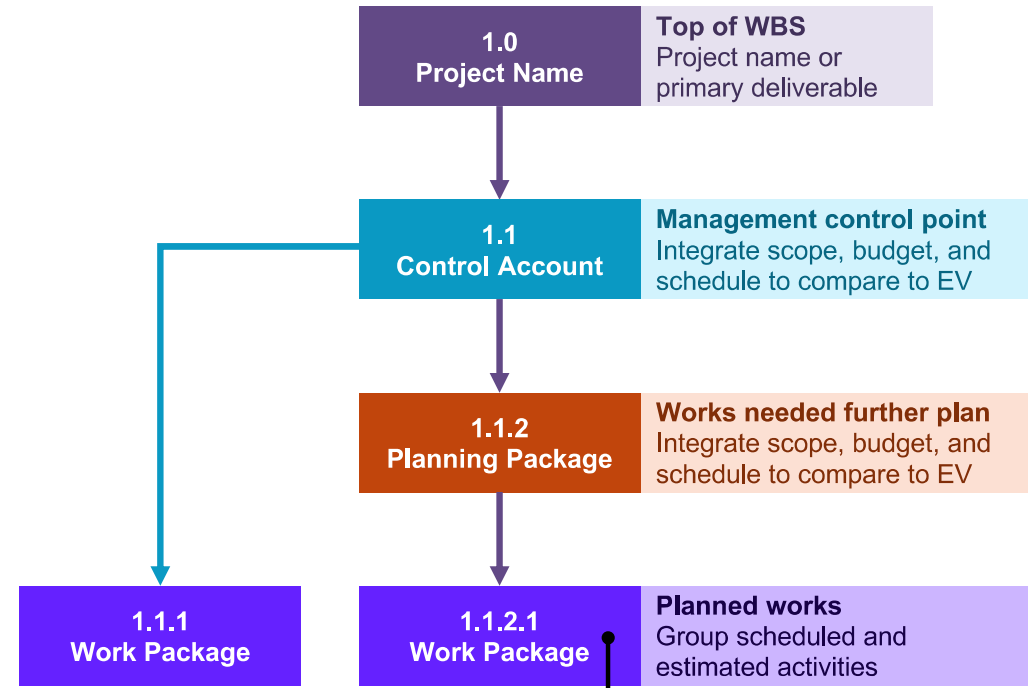

Tailor the amount of detail in activities to the project context to enable meaningful estimation and planning.

Code of accounts
(numbering system)

Activity Dependency Types



DEPENDENCY TYPES

	Meaning	Action by Project Manager
Mandatory	Contractually required or inherent in the nature of the work	Must schedule it — No way around this sequence
Discretionary	Established because of best practices or a specific sequence is desired	Can be modified as needed, if replaceable with a better sequence, or if schedule compression is required
External	Activities performed outside the project team's work	Limited or no control
Internal	In project work, contingent on inputs	Has control

ACTIVITY DEPENDENCY

A logical relationship between two project activities

DEPENDENCY TYPES

	Meaning	Action by Project Manager
Mandatory	Contractually required or inherent in the nature of the work	Must schedule it — No way around this sequence
Discretionary	Established because of best practices or a specific sequence is desired	Can be modified as needed, if replaceable with a better sequence, or if schedule compression is required
External	Activities performed outside the project team's work	Limited or no control
Internal	In project work, contingent on inputs	Has control

Precedence Relationships

- Activity dependencies determine precedence relationships (aka logical relationships) and the order in which activities are performed
- Show these using the **precedence diagramming method** (PDM)

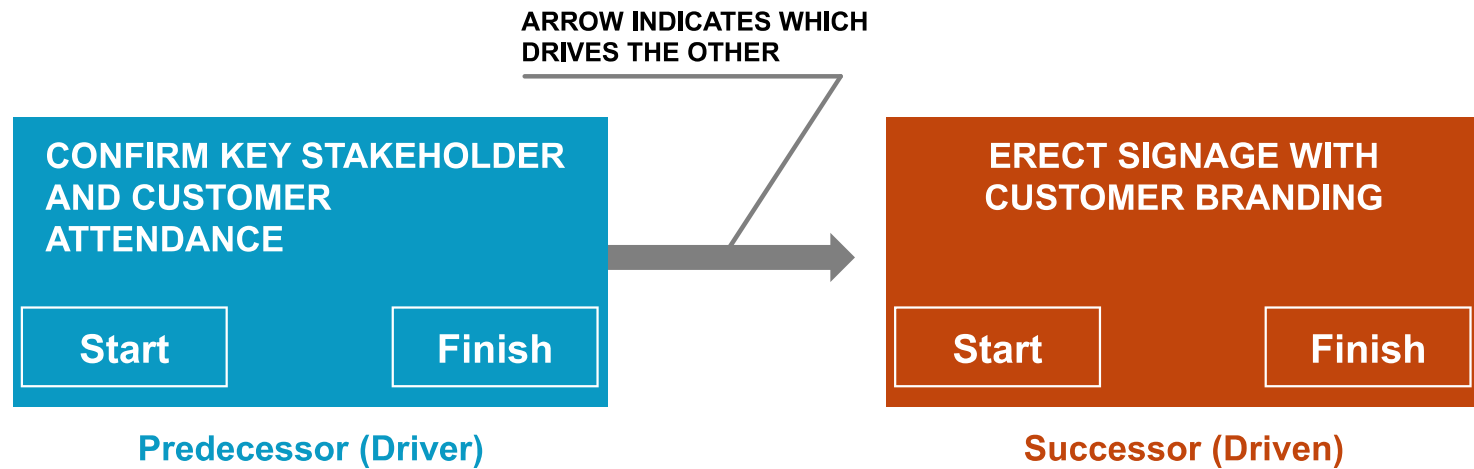

-
- Precedence indicates which activity drives the relationship
 - Predecessor usually occurs earlier in time than successor



PRECEDENCE DIAGRAMMING METHOD

A technique used to create the network diagram. It constructs a schedule model in which activities are represented by nodes and are graphically linked by one or more logical relationships to show the sequence in which the activities are to be performed.

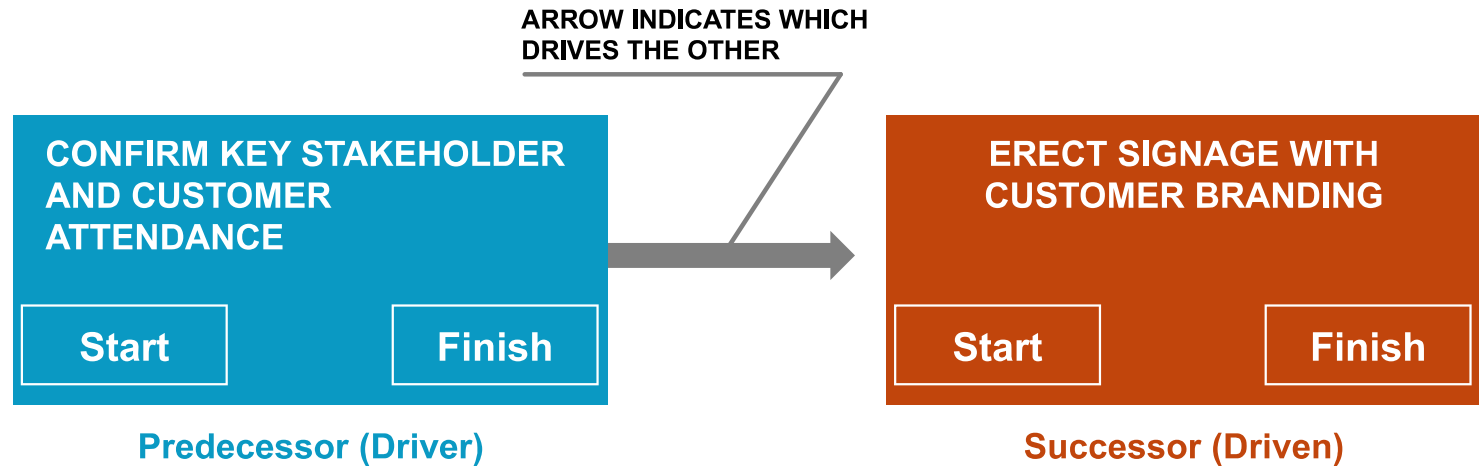

- Precedence indicates which activity drives the relationship
- Predecessor usually occurs earlier in time than successor

Types of Precedence Relationships

- A. Obtain occupancy permit from Oasestown building department
- B. Confirm tour guide
- C. Confirm key stakeholder and customer attendance
- D. Complete landscaping and decoration
- E. Identify finished spaces for the tour
- F. Erect signage with customer branding

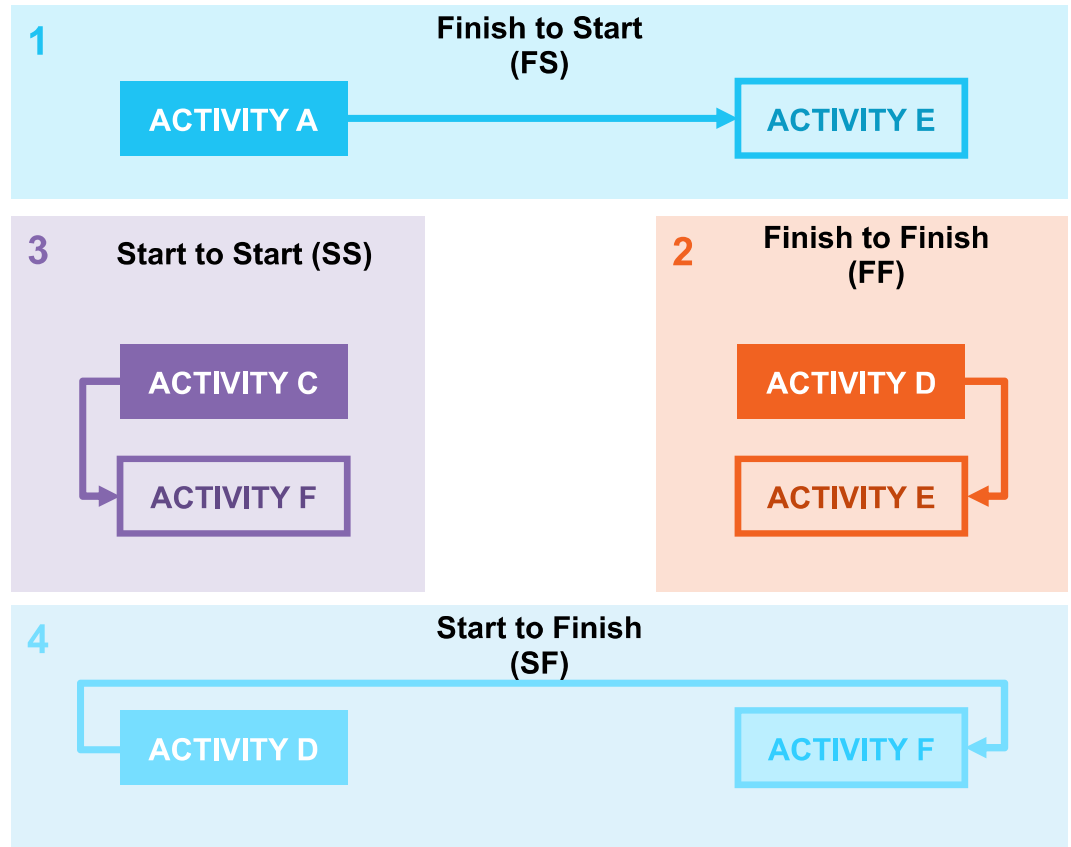

Lags and Leads in Precedence Relationships

Add **lead** and **lag** times of up to 2 weeks to activities

Document activities and related assumptions

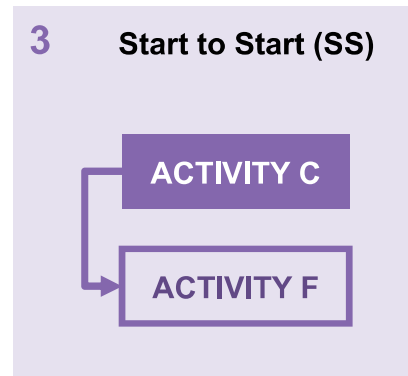
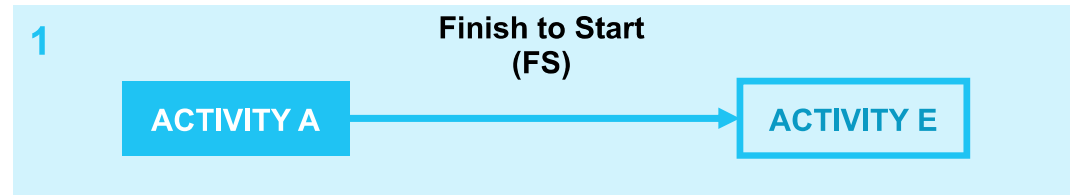

- A. Obtain occupancy permit from Oasestown building department
- B. Confirm tour guide
- C. Confirm key stakeholder and customer attendance
- D. Complete landscaping and decoration
- E. Identify finished spaces for the tour
- F. Erect signage with customer branding



Leads and lags do not have a value, so do not include them in duration estimates.

Leads in Precedence Relationships

LEAD

The amount of time a successor activity can be advanced with respect to a predecessor activity.

LAG

The amount of time a successor activity will be delayed with respect to a predecessor activity.

g times of up to ties

ies and related

and lags do not have a value, so do not include them in duration estimates.

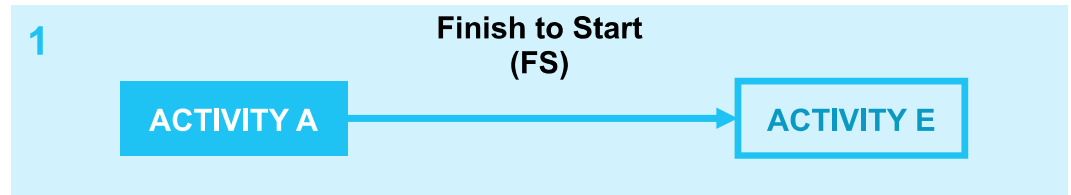

- A. Obtain occupancy permit from Oasestown building department
- B. Confirm tour guide
- C. Confirm key stakeholder and customer attendance
- D. Complete landscaping and decoration
- E. Identify finished spaces for the tour
- F. Erect signage with customer branding

Activity Duration Estimate Terminology



Activity Duration Estimate

- The quantitative assessment of the likely number of time periods required to complete an activity

Elapsed time

- The actual calendar time required for an activity from start to finish

Effort

- The number of labor units required to complete a scheduled activity or WBS component, often expressed in hours, days, or weeks; contrast with duration

Estimating Techniques



Analogous	<ul style="list-style-type: none"> • Uses historical data from a similar activity or project to estimate duration (or cost) • aka “top-down estimating.” 	<ul style="list-style-type: none"> • Less costly and time consuming • Used when project information is limited 	<ul style="list-style-type: none"> • May be inaccurate, depending on quality of historical information
Parametric	<ul style="list-style-type: none"> • Uses an algorithm to calculate duration (or cost) based on historical data and project parameters. • Durations can be quantitatively determined — multiply quantity of work to be performed by the number of labor hours per unit of work 	<ul style="list-style-type: none"> • Can produce higher levels of accuracy depending on sophistication of data from model • Scalable and linear 	<ul style="list-style-type: none"> • Does not account for a learning curve — i.e., work gets easier as team becomes more expert • Uniform units of work are not typical in projects
Three-Point	<ul style="list-style-type: none"> • Defines an approximate range of an activity’s duration, using most likely, optimistic, and pessimistic estimates • Used when historical data is insufficient, or subjective 	<ul style="list-style-type: none"> • May improve accuracy of single-point estimations by including risk and uncertainty factors 	<ul style="list-style-type: none"> • Requires detailed resource information • Requires expert knowledge to estimate tasks
Bottom-up	<ul style="list-style-type: none"> • Uses aggregates of the estimates of the lower level components of the WBS 	<ul style="list-style-type: none"> • Very accurate and gives lower-level managers more responsibility 	<ul style="list-style-type: none"> • May be very time consuming • Can be used only after the WBS has been well defined

Three-Point Estimation Examples

Triangular Distribution (average)

FORMULA

$$E = (O + M + P) / 3$$

- Optimistic = 3 weeks
- Most Likely = 5 weeks
- Pessimistic = 10 weeks

EQUATION

$$(3 + 5 + 10) / 3 = 6 \text{ weeks}$$



PERT is based on a probability distribution; therefore, we can calculate a standard deviation:

$$(P - O) / 6 = \text{PERT Standard Deviation}$$

Beta Distribution (PERT average)

FORMULA

$$E = (O + 4M + P) / 6$$

- Optimistic estimate = 3 weeks
- **Weighted** most likely estimate = 5 weeks
- Pessimistic estimate = 10 weeks

EQUATION

$$[3 + 4 (5) + 10] / 6 = 5.5 \text{ weeks}$$

Critical Path* Method

Sequence mandatory **critical path activities** to find the longest path through a project and to determine the **shortest possible project duration** and the amount of **flexibility** in the schedule

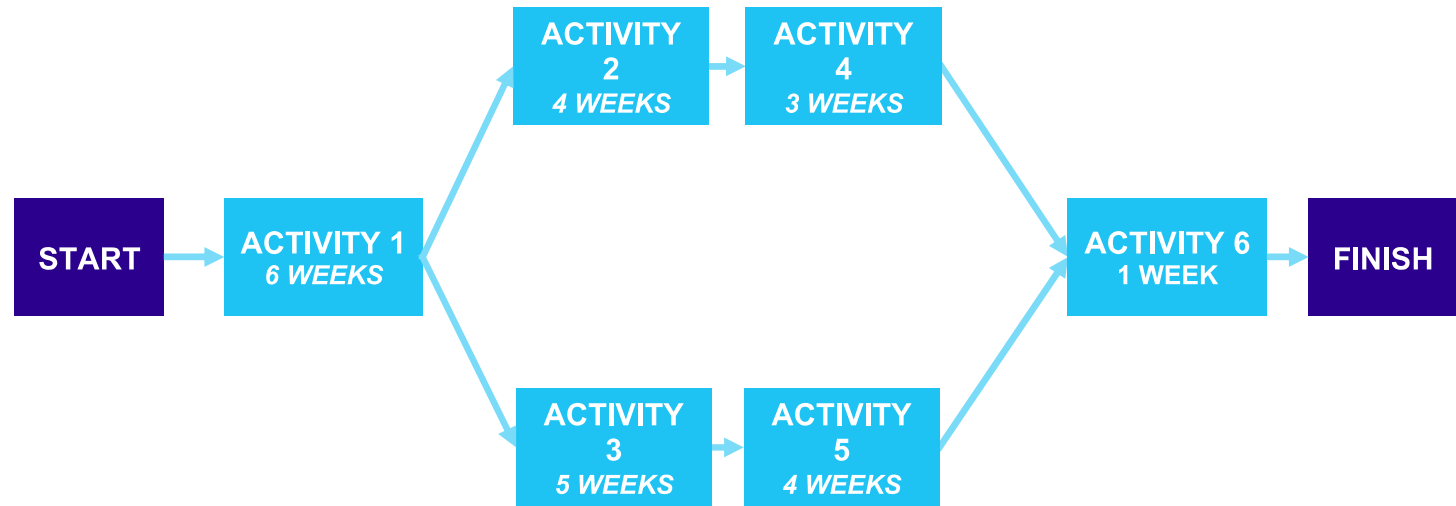

$$1[6w] + 2[4w] + 4[3w] + 6[1w] = 14\text{-weeks}$$

$$1[6w] + 3[5w] + 5[4w] + 6[1w] = 16\text{-week critical path}$$



CRITICAL PATH METHOD

A technique of schedule analysis in which the schedule activities are evaluated to determine the float or slack for each activity and the overall schedule. To calculate critical path, use the forward and backward pass along with float analysis to identify all network paths, including critical.

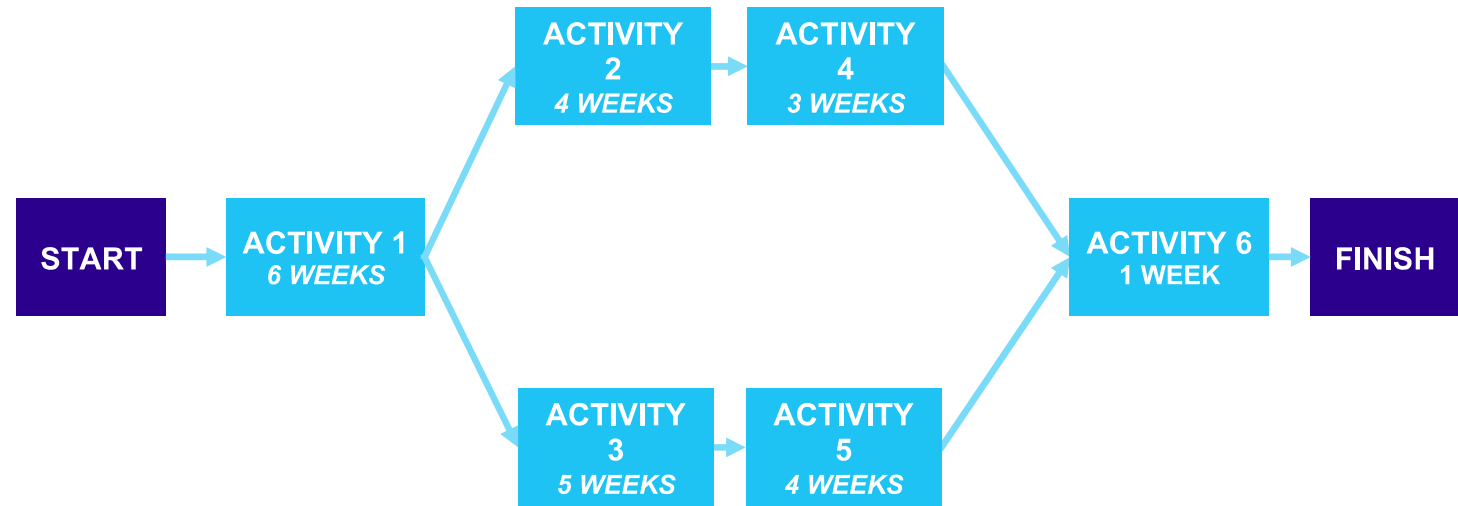

$$1[6w] + 2[4w] + 4[3w] + 6[1w] = 14\text{-weeks}$$

$$1[6w] + 3[5w] + 5[4w] + 6[1w] = 16\text{-week critical path}$$

Working with the Critical Path



Working with the Critical Path

Spotlight Series

In this presentation, the spotlight is focused on Working with the Critical Path!



Network Diagram with Date and Dependencies

Calculate:

- Critical path
- Forward pass
- Backward pass
- Float

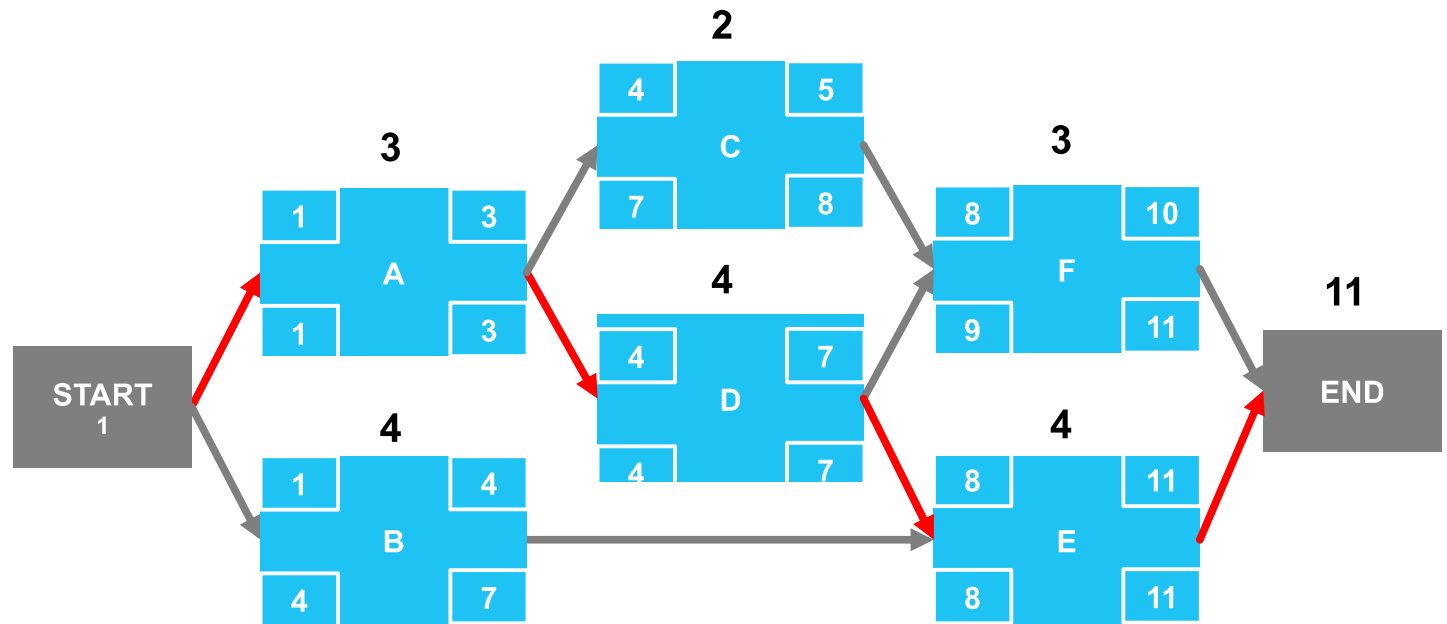

KEY

ES	DUR	EF
ACTIVITY		
LS	FLT	LF

FLOAT

The difference between the early and late dates

Total float is within an activity; **free float** is between two activities.

Total float is the amount of time that a schedule activity can be delayed or extended from its early start date without delaying the project finish date or violating a schedule constraint.

Free float is the amount of time that a scheduled activity can be delayed without impacting the early start date of any subsequent scheduled activity.

Use **early start (ES)**; **early finish (EF)**; **late start (LS)**; and **late finish (LF)** dates for all activities.

EARLY FINISH DATE (EF)

The earliest possible point in time when the uncompleted portions of a schedule activity can finish based on the schedule network logic, the data date, and any schedule constraints.

EARLY START DATE (ES)

The earliest possible point in time when the uncompleted portions of a schedule activity can start based on the schedule network logic, the data date, and any schedule constraints.

LATE FINISH DATE (LF)

The latest possible point in time when the uncompleted portions of a schedule activity can finish based on the schedule network logic, the project completion date, and any schedule constraints.

LATE START DATE (LS)

The latest possible point in time when the uncompleted portions of a schedule activity can start based on the schedule network logic, the project completion date, and any schedule constraints.

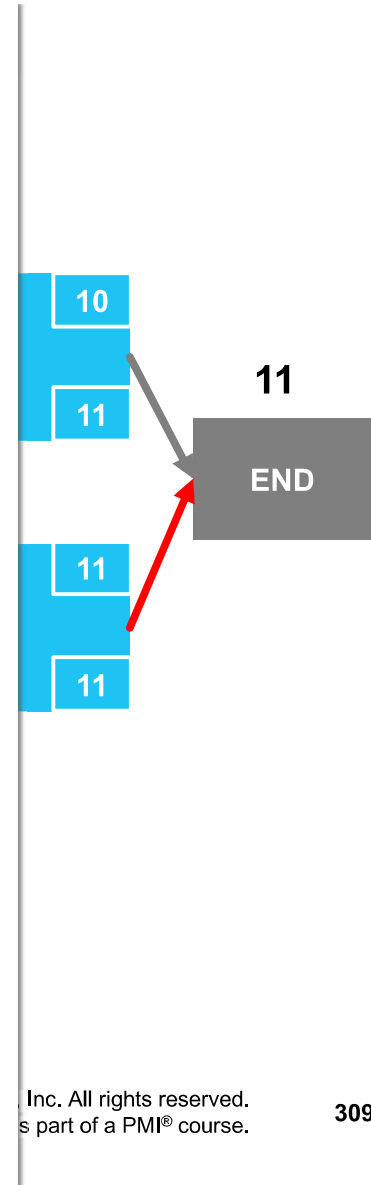

The Project Schedule



-
- Includes start and finish activities
 - Uses specific dates and in a certain sequence
 - Sets dates for project milestones
 - Coordinates activities to ensure on-time project completion
 - Tracks project progress based on schedule performance and provides visibility of project status to upper management and project stakeholders

Schedule Presentation Formats

Select the type of schedule to suit your project!

- Roadmap
- Gantt Chart
- Milestone Chart
- Project Schedule Network Diagram



Do you remember the name of the tool we used for scheduling activities in a project plan?

Hint: *The output is a project schedule network diagram.*

Gantt Chart

Visualize and Track the Project Over a Time Line

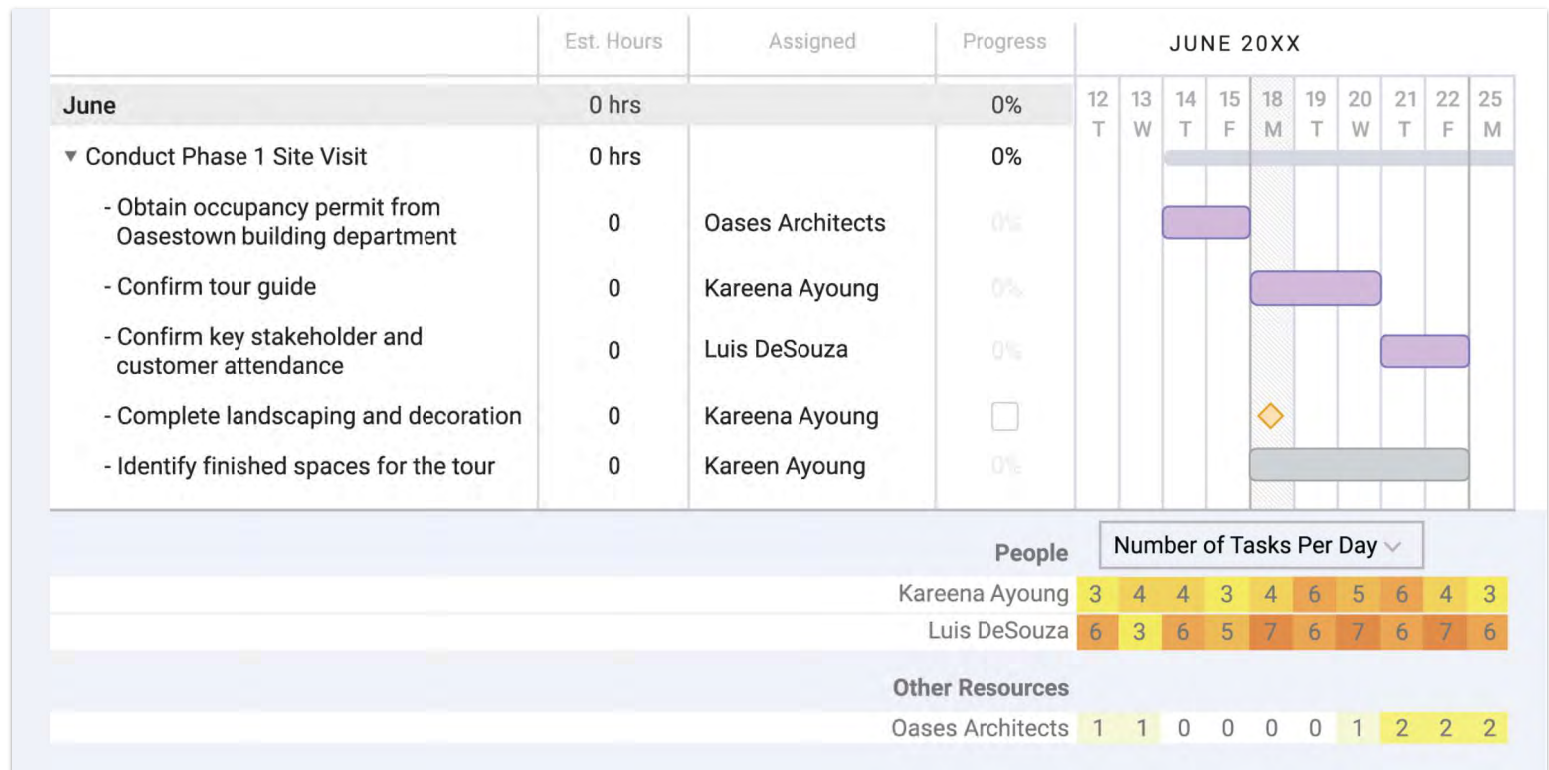

Milestone Schedule

Present Milestones with Planned Dates

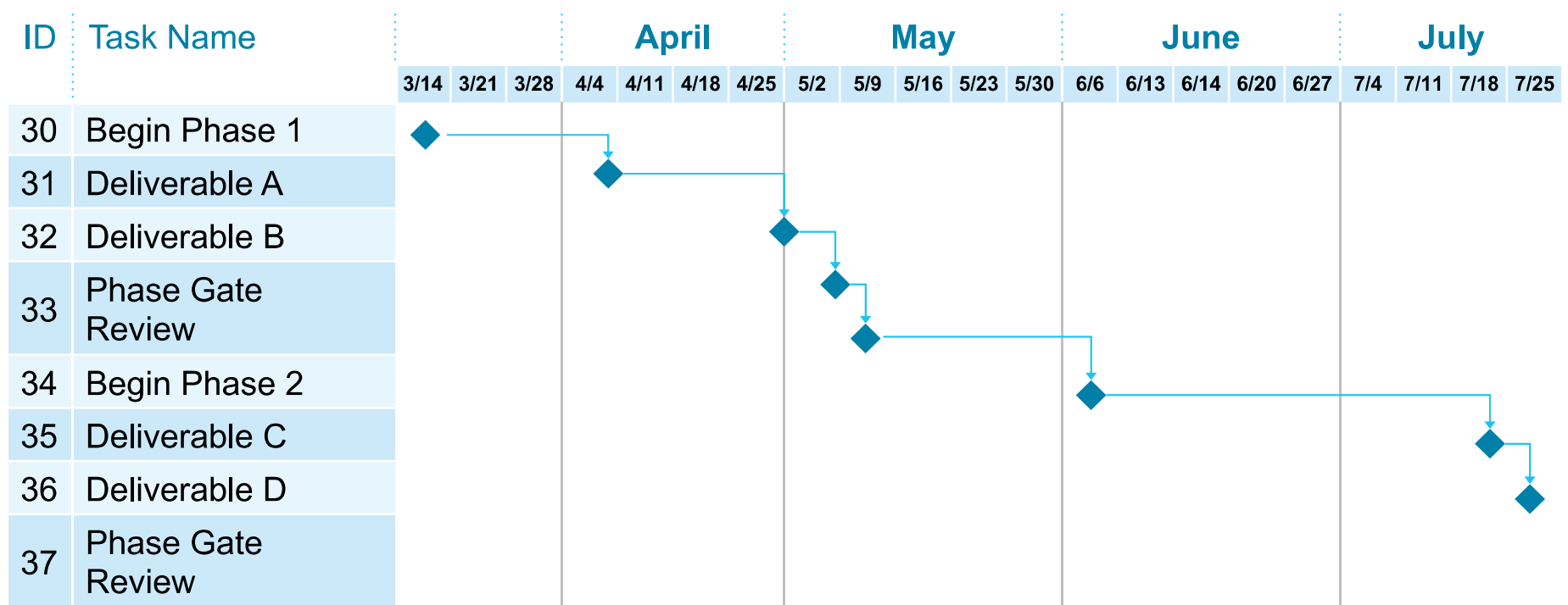

Remember that milestones have zero duration

Project Schedule Network Diagram

Visualize Interrelationships of Activities

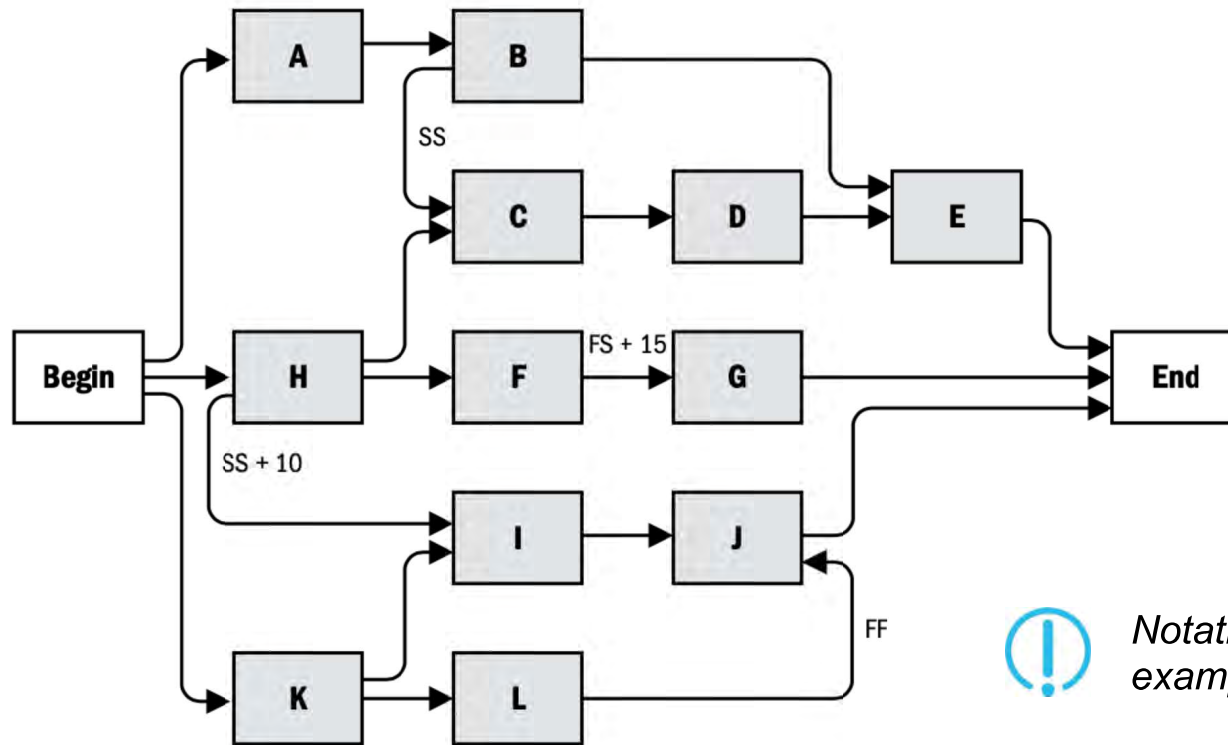

Notations are for graphical example only!

Resource Optimization

Smoothing

- Adjusts the activities within predefined resource limits and within free and total floats
- Does not change the critical path nor delay the completion date
- Method may not be able to optimize all resources

Levelling

- Adjusts start and finish dates based on resource constraints
- Goal is to balance demand for resources with available supply
- Use when shared or critically required resources have limited availability or are over-allocated
- Can change the critical path



RESOURCE SMOOTHING

A resource optimization technique in which free and total float are used without affecting the critical path. See also “Resource Levelling” and “Resource Optimization Technique”.

RESOURCE LEVELLING

A resource optimization technique in which adjustments are made to the project schedule to optimize the allocation of resources and which may affect the critical path.

Smoothing

- Adjusts the activities within predefined resource limits and within free and total floats
- Does not change the critical path nor delay the completion date
- Method may not be able to optimize all resources

Levelling

- Adjusts start and finish dates based on resource constraints
- Goal is to balance demand for resources with available supply
- Use when shared or critically required resources have limited availability or are over-allocated
- Can change the critical path

Schedule Compression Techniques

Fast tracking

- Perform activities in parallel to reduce time
- May result in rework, increased risk and increased cost

Crashing

- Shortens schedule duration for the least incremental cost by adding resources – e.g., overtime, additional resources
- Works only for activities on the critical path
- Does not always produce a viable alternative and may result in increased risk and/or cost

FAST TRACKING

A schedule compression technique in which activities or phases normally done in sequence are performed in parallel for at least a portion of their duration.

CRASHING

Applying additional resources to one or more tasks/activities to complete the work more quickly. Crashing usually increases costs more than risks. In comparison, fast-tracking increases risks.

Fast tracking

- Perform activities in parallel to reduce time
- May result in rework, increased risk and increased cost

Crashing

- Shortens schedule duration for the least incremental cost by adding resources – e.g., overtime, additional resources
- Works only for activities on the critical path
- Does not always produce a viable alternative and may result in increased risk and/or cost

Schedule Baseline*

- Complete schedule planning activities
- Add the schedule baseline to the **project management plan**



Ideally, this happens before the project starts.

- Compare actual progress to the baseline while the team works
- Use the formal change control process to make changes to the baseline

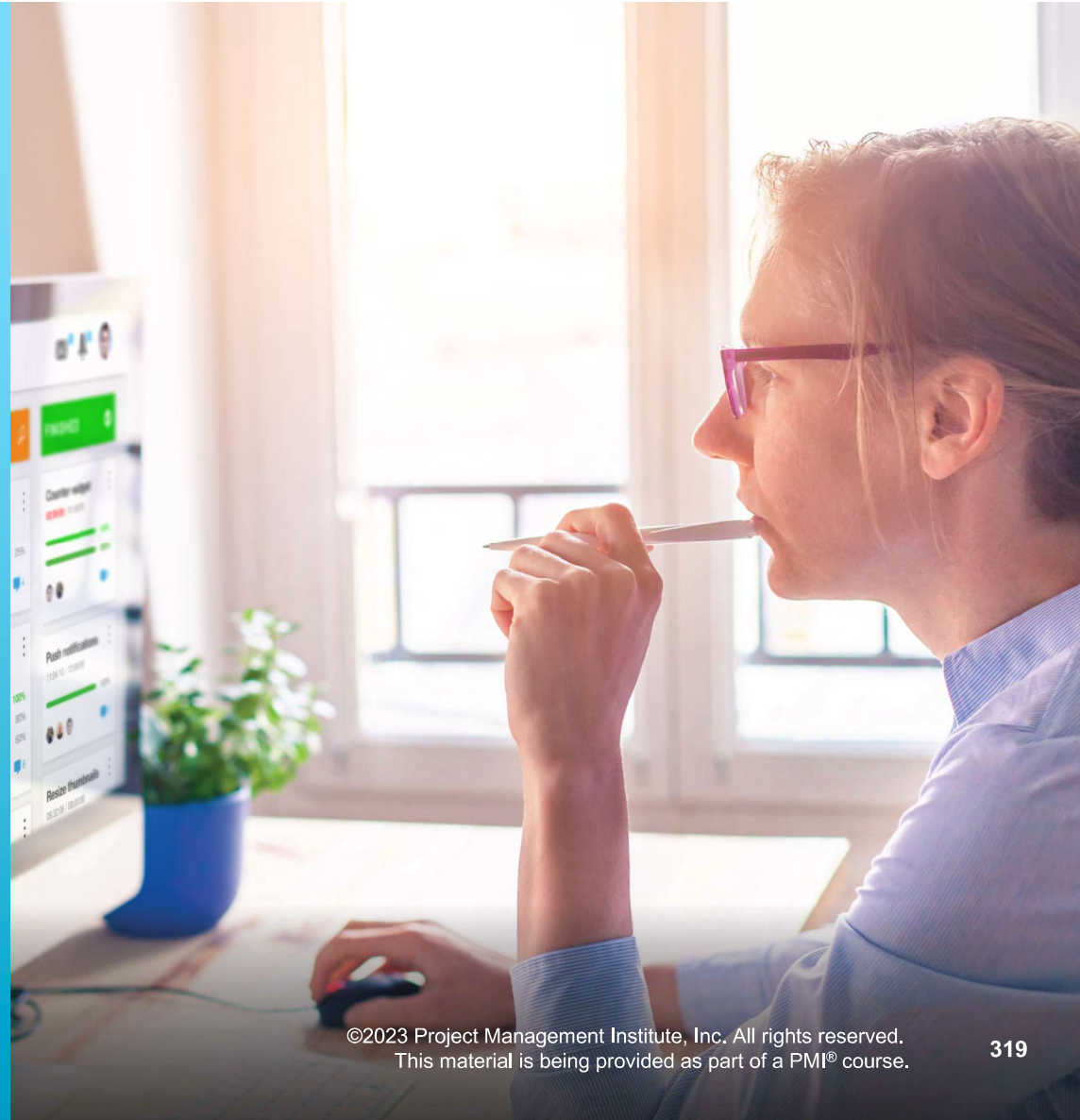

SCHEDULE BASELINE

The approved version of a schedule model that can be changed using formal change control procedures and is used as the basis of comparison to actual results. It is one of the main project documents that should be created before the project starts.

e*

activities

the **project**

ore the project

he baseline while

l process to make

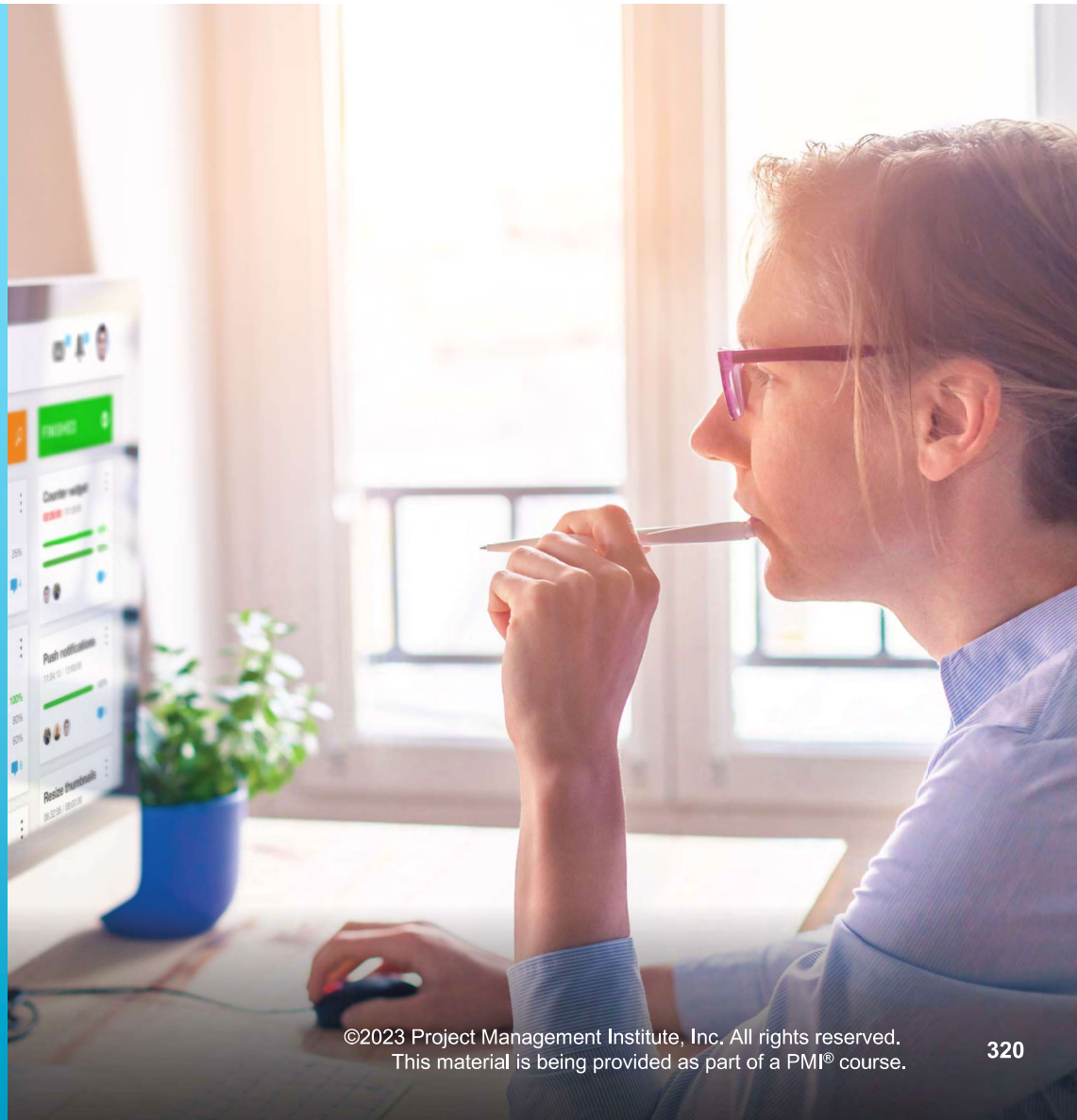

Special Intervals



What are special intervals known as in your projects?



Negotiate how and when required scheduled “down” time intervals will take place

Black-out times - deliverables are handed over for implementation:

- Suspends changes
- Reduces risks as the solution is released to customers

“Go Live” - at the end of the project timeline



Negotiate black-out times as project approaches release

Iteration H or **hardening sprint** – conducted prior to final release

HARDENING ITERATION / ITERATION H

Specialized increment/
iteration/sprint dedicated
to stabilizing the code
base so that it is robust
enough for release. No
new functionality is added.
Primarily used for
refactoring and/or
technical debt.



Negotiate how and when required scheduled “down” time intervals will take place

Black-out times - deliverables are handed over for implementation:

- Suspends changes
- Reduces risks as the solution is released to customers

“Go Live” - at the end of the project timeline



Negotiate black-out times as project approaches release

Iteration H or **hardening sprint** – conducted prior to final release

Schedule Management in Adaptive Environments Guidelines



-
- Depends on team composition and life cycle
 - Project team works with the product owner to decide
 - Develop the roadmap to show release functionality and timeframes
 - Choose an approach:
 - Timeboxed scheduling with backlog
 - On-demand, continuous scheduling
 - Project team selects activities for delivery within an iteration (or sprint)
 - Teams produce increments of value for delivery and feedback

Adaptive Scheduling Approaches

Comparative View

On-Demand (Kanban/Lean-based)

- Allows individual requests to be addressed
- Levels out work of team members
- Best when activities are divided equally



Does not work well in projects with complex dependency relationships

Timeboxed/Iterative

- Uses progressive elaboration (rolling wave) to schedule activities
- Uses a specific work interval — e.g., two weeks
- Allows changes at any time during project

Prioritize requests to determine start sequence then sequence stories individually through completion

Define requirements with user stories then prioritize stories

Team pulls work from queue

Select work based on priority and time box; add remaining stories to backlog; reintroduce stories later, based on priority

Provides incremental business value

Delivers business value early and incrementally

Adaptive Planning Overview

A release schedule usually lasts from 3-6 months.

Timeboxed iterations or sprints typically last 1 - 4 weeks.

Assign story points to tasks to determine the amount of work

Velocity – the capacity of the team to complete work

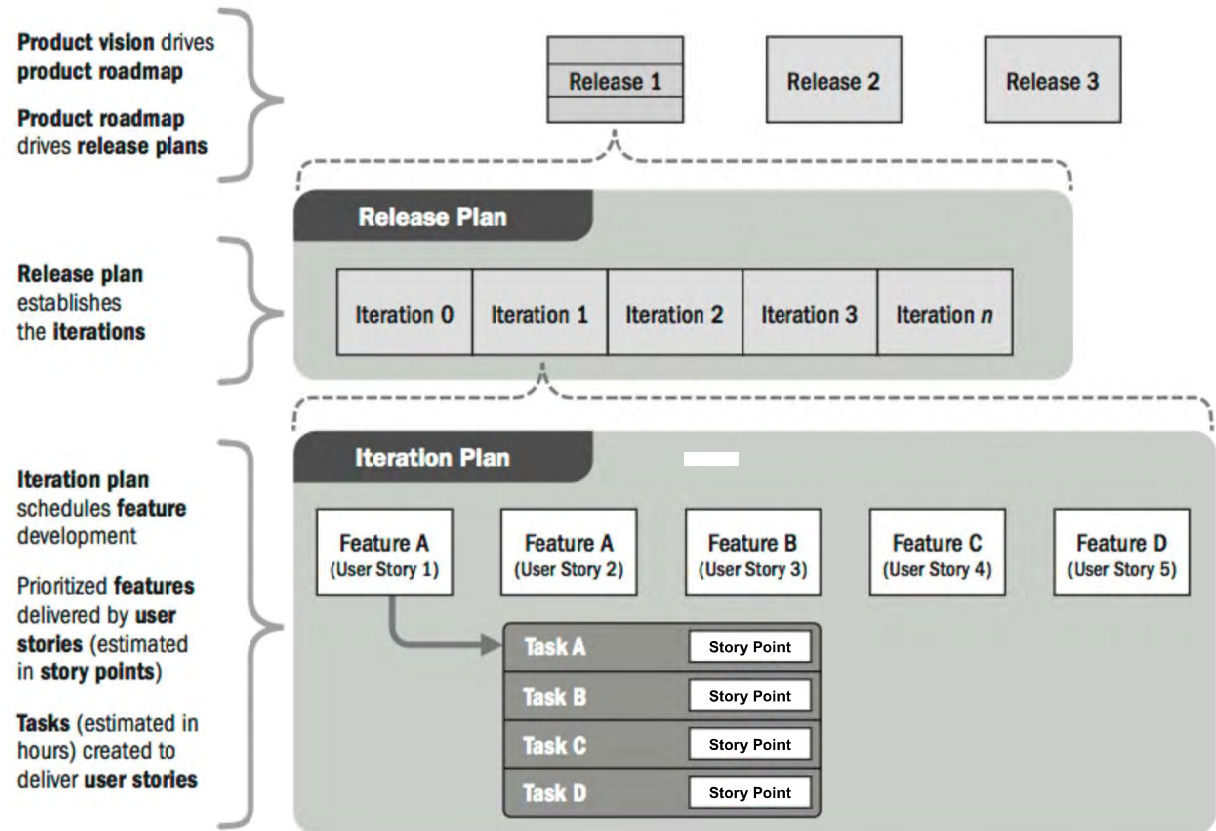

Planning Overview

SPRINT VELOCITY

A descriptive metric used by agile and hybrid teams. It describes the volume of work that a team performs during a sprint. Use this metric to understand the rate of your team's work during an average sprint.

e usually
ths.
ns or
t 1 - 4
s to
the
acity of
ete work

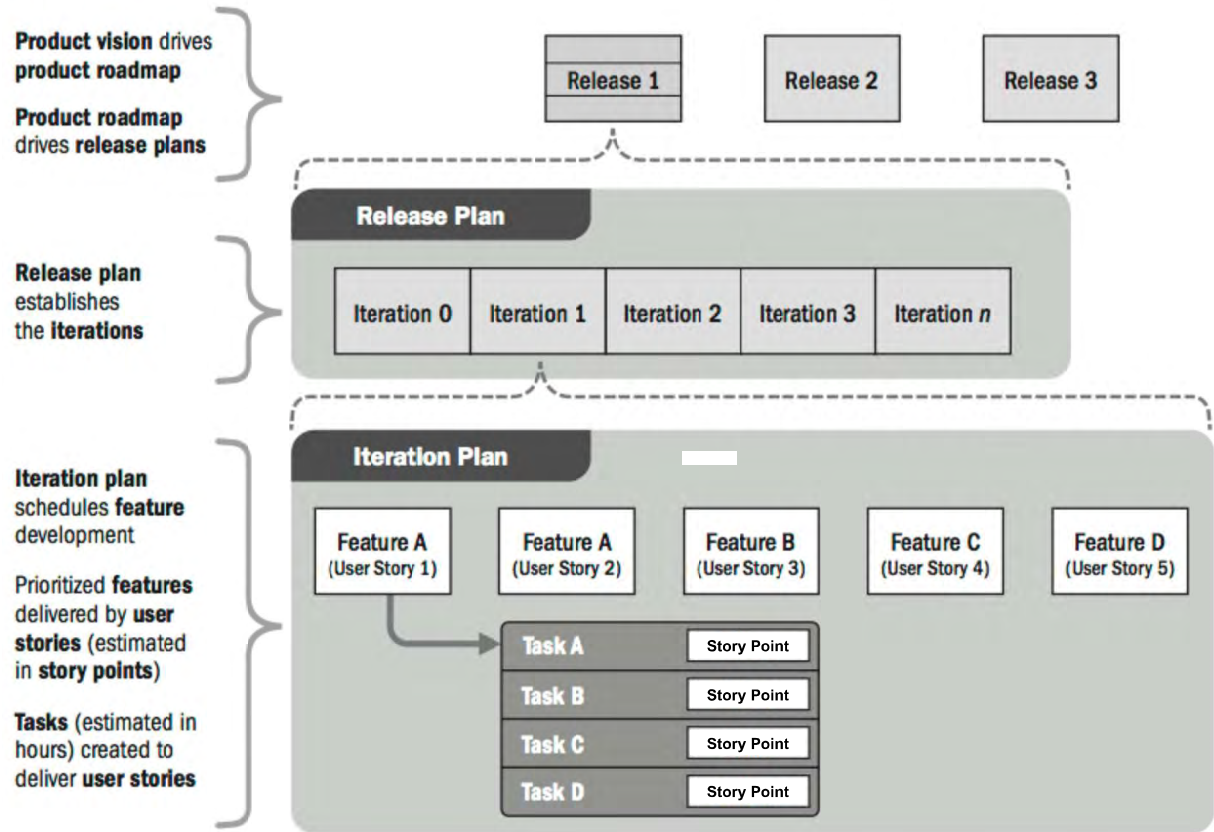

Working with Features

Scheduling aligned to features ensures associated work is coordinated.

Associating features with the **product roadmap** offers visibility of when blocks of functionality can be released to the business and end users.



Agile Release Planning

Story Mapping

- Group stories by **sequence** and **priority**
- Sequence **features** and functions for the release
- Prioritize user stories in the **release backlog** and associate them with features and functions



Sequence of features needed in release

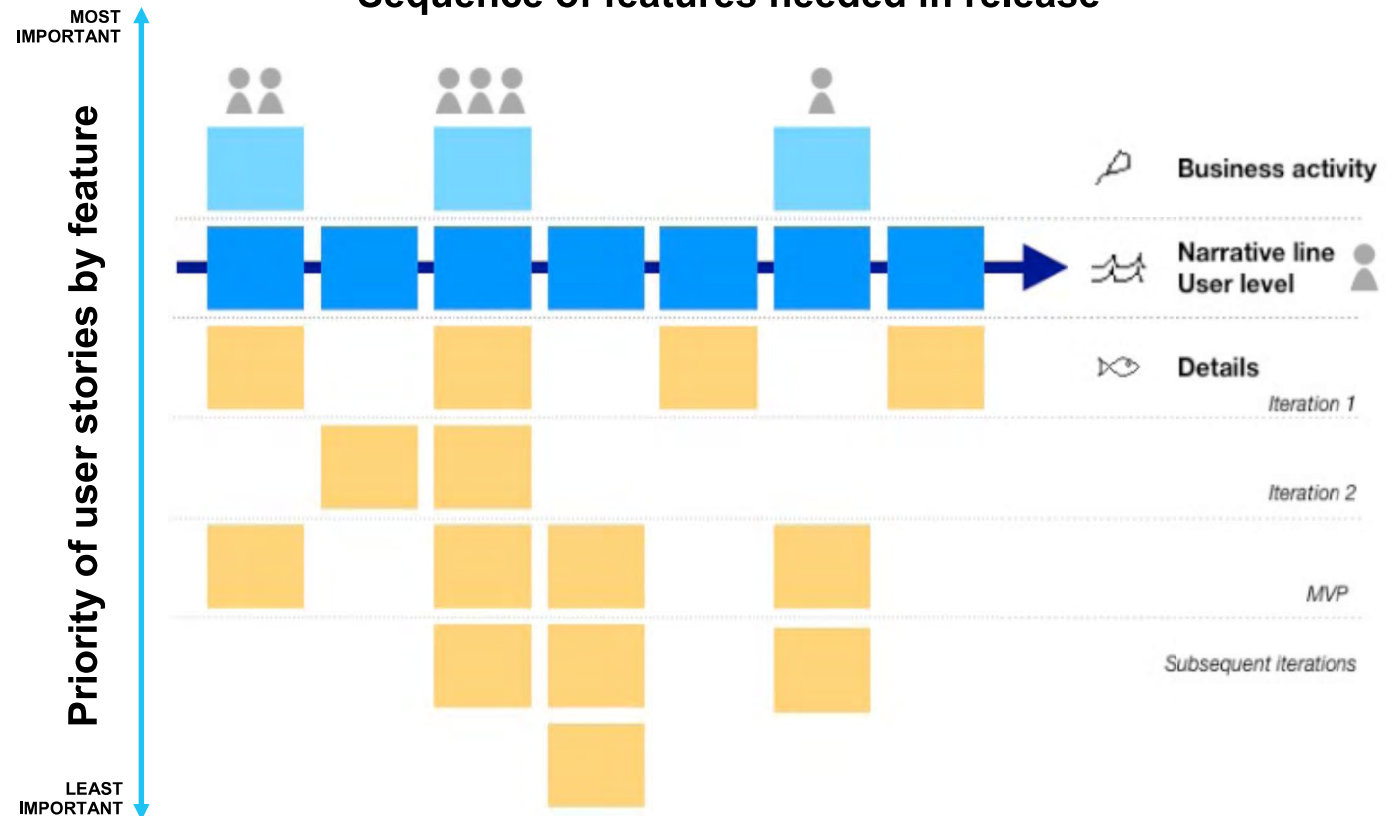

Measure Effort, Not Time

Relative sizing

- Compares effort of multiple user stories through assignment of values (XS, S, M, L, XL)



*Use common **t-shirt sizes** to assign values to user stories.*

Story points

- Uses a relative measure – e.g., numbers in the **Fibonacci sequence** – to identify the level of difficulty or complexity of a user story or task

Planning poker

- Estimates effort or relative size of development effort
- Uses a deck of cards with modified Fibonacci numbers to vote on user stories



Planning Poker



Planning Poker

Spotlight Series

Let's shine a spotlight on
Planning Poker!

Definition of Ready (DoR)* and Definition of Done (DoD)*



Agile teams need to know when they can be “ready” to do the work and when that work is “done.”

DoR - What needs to be in place so the team can begin work?

- Depends on the environment’s complexity and lessons learned from past iterations.
- Use DoR checklist to communicate and collaborate with stakeholders about readiness for work or progress.

DoD describes the goal or desired state. It must be informed by the DoR.



*DoD is similar to **acceptance criteria** in predictive projects.*

DEFINITION OF READY (DOR)

A team's checklist for a user-centric requirement that has all the information the team needs to be able to begin working on it.

DEFINITION OF DONE (DOD)

A team's checklist of all the criteria required to be met so that a deliverable can be considered ready for customer use.

Agile teams need to know when they can be “ready” to do the work and when that work is “done.”

DoR - What needs to be in place so the team can begin work?

- Depends on the environment's complexity and lessons learned from past iterations.
- Use DoR checklist to communicate and collaborate with stakeholders about readiness for work or progress.

DoD describes the goal or desired state. It must be informed by the DoR.



*DoD is similar to **acceptance criteria** in predictive projects.*

Reprioritize Sprint / Iteration Backlog*



The product owner and team collaborate to move work items from a release backlog to an **iteration/sprint backlog** for the upcoming sprint.

Team holds a sprint planning meeting before each sprint, which typically lasts 2 weeks.

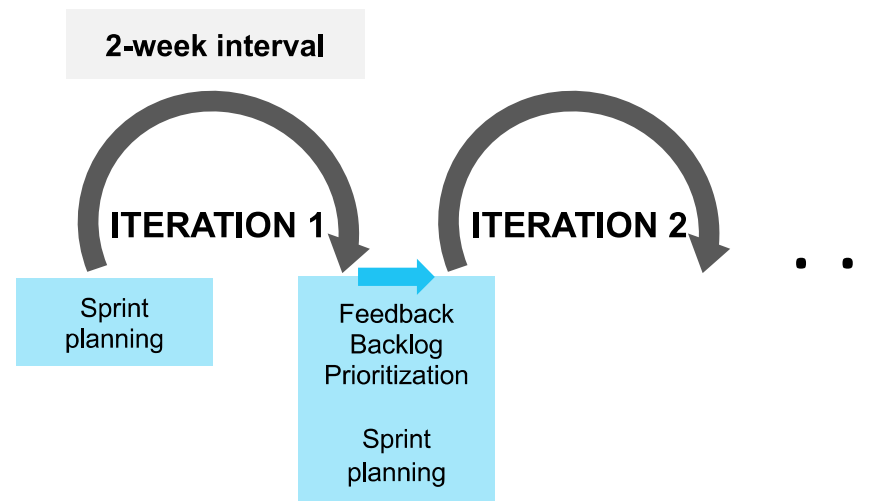

ITERATION BACKLOG

The work that is committed to be performed during a given iteration and is expected to burn down the duration. The work does not carry over to the next iteration.

The product owner and team collaborate to move work items from a release backlog to an **iteration/sprint backlog** for the upcoming sprint.

Team holds a sprint planning meeting before each sprint, which typically lasts 2 weeks.

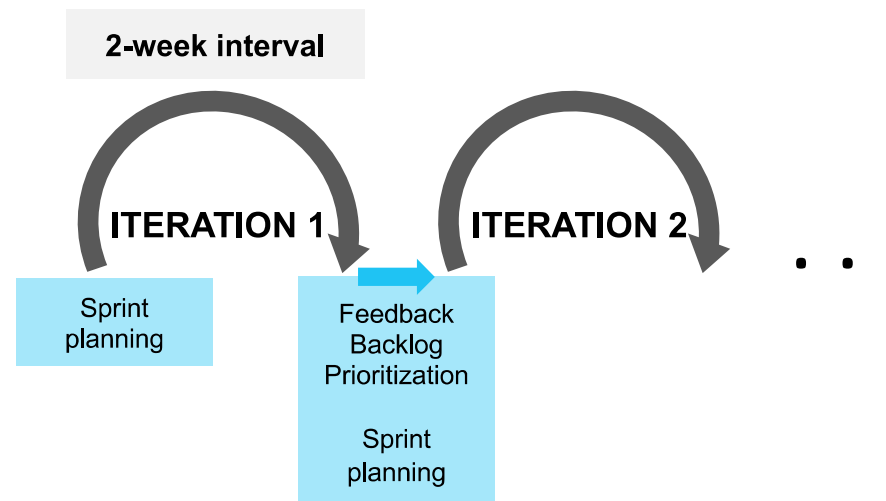

Hybrid Scheduling Models

Example



Can you identify which aspects of this scheduling model are predictive and which are adaptive?

Can you identify who does each of the tasks listed?

Project manager plans high-level project phases and milestones; scrum master runs sprints using agile processes

- Identify project work types and try to break them down
- Create a prioritized work backlog which fulfills project phase or achieves milestone
- Work in iterations/sprints of 2 - 4 weeks (use shorter sprints for less experienced team to facilitate alignment)
- Plan work before every iteration using prioritized backlog items
- Estimate every task to decide how many can fit in a single sprint
- Hold a retrospective at the end of every sprint; capture metrics to adjust timing and task estimate for next sprint

ECO Coverage

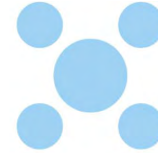

2.6 Plan and manage schedule

- Predictive vs adaptive approach for schedule
- Estimate project tasks (milestones, dependencies, story points) (2.6.1)
- Utilize benchmarks and historical data (2.6.2)
- Prepare schedule based on methodology (2.6.3)

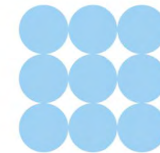
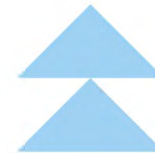



Resources

TOPIC D

Resources

People and Equipment

- Value and empower internal human resources, yet
- Leverage external sources to ensure you have the best team and equipment possible!



Resource Management Plan*



- **Identify resources** - People and equipment
- **How to acquire them**
- **Peoples' roles and responsibilities**
 - Role – A person's function in a project
 - Authority - Rights to use resources, make decisions, accept deliverables.
 - Responsibility - Assigned duty
 - Competencies and skills required
- **Project Organization Chart** – (Visual with resource categories and reporting relationships)
- **Project team resource management** – Guidance on how to define, select, manage and release resources
- **Training** - Strategies and requirements
- **Team development methods**
- **Resource controls** - Methods for ensuring non-human-resources are available as needed
- **Recognition plan**

RESOURCE MANAGEMENT PLAN

A component of the project management plan that describes how project resources are acquired, allocated, monitored, and controlled.

- **Identify resources** - People and equipment
- **How to acquire them**
- **Peoples' roles and responsibilities**
 - Role – A person's function in a project
 - Authority - Rights to use resources, make decisions, accept deliverables.
 - Responsibility - Assigned duty
 - Competencies and skills required
- **Project Organization Chart** – (Visual with resource categories and reporting relationships)
- **Project team resource management** – Guidance on how to define, select, manage and release resources
- **Training** - Strategies and requirements
- **Team development methods**
- **Resource controls** - Methods for ensuring non-human-resources are available as needed
- **Recognition plan**

Assign Resources and Allocate Responsibilities



-
- Assign team members to project
 - Decide roles and responsibilities
 - Create team directory, organization chart and the schedule



Project schedules, resource assignments and budgets are all interrelated and can be created at the same time.

- Tailor responsibilities according to team, needs and project approach
- Consider technical and “soft” skills:
 - Experience, knowledge, skills
 - Attitude
 - Global/regional factors

Use Resource Calendars*

- Document resource availability (people, equipment, material, etc.) during a planned activity period.
- Use when estimating project activities and understanding dependencies
- Specifies when, and for how long, identified team and physical resources will be available during the project
- Progressively elaborate and update it throughout the project



Resource calendars can be used in any kind of project!



RESOURCE CALENDAR

A calendar that identifies the working days and shifts for which each specific resource is available.

-
- Document resource availability (people, equipment, material, etc.) during a planned activity period.
 - Use when estimating project activities and understanding dependencies
 - Specifies when, and for how long, identified team and physical resources will be available during the project
 - Progressively elaborate and update it throughout the project



Resource calendars can be used in any kind of project!

Responsibility Assignment Tools



Responsibility assignment matrix (RAM) or **RACI** chart:

- Designates types of accountabilities assigned to resources or stakeholders
- Keeps information visible



RESPONSIBLE

A team member

- Performs work to complete the task or create the deliverable
- Every task has at least one responsible person

ACCOUNTABLE

*On the team
(leadership/
management)*

- Delegates and reviews the work involved in a project
- Ensures the responsible person/team knows project expectations and completes work on time
- Each task has only one accountable person

CONSULTED

Stakeholders

- Provides input and feedback on project work
- Not every task or milestone needs a consulted party



Consider all stakeholders, but invite only necessary input

INFORMED

*Usually not project
decision makers*

- Needs to be informed of project progress because their work might be affected, but don't need details

RACI CHART

Stands for Responsible, Accountable, Consulted, and Informed. A common type of responsibility assignment matrix (RAM) that uses responsible, accountable, consult, and inform statuses to define the involvement of stakeholders in project activities.

RESPONSIBLE

A team member

- Performs work to complete the task or create the deliverable
- Every task has at least one responsible person

ACCOUNTABLE

*On the team
(leadership/
management)*

- Delegates and reviews the work involved in a project
- Ensures the responsible person/team knows project expectations and completes work on time
- Each task has only one accountable person

CONSULTED

Stakeholders

- Provides input and feedback on project work
- Not every task or milestone needs a consulted party



Consider all stakeholders, but invite only necessary input

INFORMED

*Usually not project
decision makers*

- Needs to be informed of project progress because their work might be affected, but don't need details

RACI Chart Creation



RACI Chart Creation

Spotlight Series

Now let's turn our spotlight on RACI Chart Creation!



Adaptive Resource Planning

Quiz



Which of these are true? (Choose several)

- Teams self-organize to distribute work.
- Adaptive teams never have a leader.
- Team members are a mix of generalists and specialists.
- Team members should be T-shaped.

Adaptive Resource Planning

Quiz



Which of these are true? (Choose several)

-
- Teams self-organize to distribute work. **TRUE**
 - Adaptive teams never have a leader. **FALSE**
 - Team members are a mix of generalists and specialists. **TRUE**
 - Team members should be T-shaped. **TRUE**

Filling Resource Needs

Make or Buy? Borrow?

External sourcing considerations:

- What is the impact on cost, time or quality?
- Is there an ongoing need for the specific skill set?
- How steep is the learning curve?
- Are required resources available within the organization?
- Would outsourcing allow the team to focus?

Use a **make-or-buy analysis** to make the best decision for your team.

Make-or-buy decisions are part of a procurement strategy.

MAKE-OR-BUY ANALYSIS

The process of gathering and organizing data about product/service requirements and analyzing data against available alternatives including the purchase or internal manufacture of the project.

MAKE-OR-BUY DECISIONS

Decisions made regarding the external purchase versus internal manufacture of a product.

External sourcing considerations:

- What is the impact on cost, time or quality?
- Is there an ongoing need for the specific skill set?
- How steep is the learning curve?
- Are required resources available within the organization?
- Would outsourcing allow the team to focus?

Use a **make-or-buy analysis** to make the best decision for your team.

Make-or-buy decisions are part of a procurement strategy.

Plan the Procurement Strategy

- Prerequisite OPAs
- Acquisition method
- Contract types
- Procurement phases

-
- Work with organization's finance or procurement department
 - Use pre-approved vendors before requesting a new vendor
 - Observe purchase amount limits per signatory — i.e. contracts valued over a certain threshold must be co-signed
 - Use defined bidding process and templates
 - Require RFPs for contracts valued over a certain threshold
 - Follow escalation procedures for approval of spending limits
 - Pay contracts at a defined time – e.g., upon completion of work or at the end of a project, with net payment terms

Procurement Management Plan*

-
- Specifies the types of contracts that will be used
 - Describes the process for obtaining and evaluating bids
 - Mandates standardized **procurement documents**
 - Describes how providers will be managed



Your organization's procurement function will be involved in developing this plan. Work with them closely and use the correct procurement documents to avoid problems.



PROCUREMENT MANAGEMENT PLAN

A component of the project or program management plan that describes how a project team will acquire goods and services from outside the executing organization.

PROCUREMENT DOCUMENTS

Documents used in bid and proposal activities, which include the buyer's invitation for bid, expression of interest (EOI); invitation for negotiations; request for information (RFI); request for quotation (RFQ); request for proposal (RFP); and seller's responses.

-
- Specifies the types of contracts that will be used
 - Describes the process for obtaining and evaluating bids
 - Mandates standardized **procurement documents**
 - Describes how providers will be managed



Your organization's procurement function will be involved in developing this plan. Work with them closely and use the correct procurement documents to avoid problems.

Procurement Documents

Bid and Proposal Activities

-
- **Statement of Work (SOW):** Details of work required
 - **Request for quotation (RFQ):** Bid/tender or quotation, including only cost
 - **Invitation for Bid (IFB):** Buyer requests expressions of interest in work
 - **Request for information (RFI):** Buyer requests more information from seller
 - **Request for proposal (RFP):** Buyer-issued statement of work required
 - **Expression of Interest (EOI):** Seller-issued expression of interest in work

STATEMENT OF WORK (SOW)

A narrative description of products, services, or results to be delivered.

REQUEST FOR PROPOSAL (RFP)

A type of procurement document used to request proposals from prospective sellers of products or services. In some application areas, it may have a narrower or more specific meaning.

-
- **Statement of Work (SOW):** Details of work required
 - **Request for quotation (RFQ):** Bid/tender or quotation, including only cost
 - **Invitation for Bid (IFB):** Buyer requests expressions of interest in work
 - **Request for information (RFI):** Buyer requests more information from seller
 - **Request for proposal (RFP):** Buyer-issued statement of work required
 - **Expression of Interest (EOI):** Seller-issued expression of interest in work

Formal Procurement Processes

RFPs, Bidder Conferences

Organizations in highly regulated industries or government

Or, if a project needs specialist work or wants to find the best quality available.

Use RFPs, **bidder conferences**, and formal processes to ensure **all prospective vendors have a clear and common understanding of the procurement**

Work closely with the procurement officer or department

BIDDER CONFERENCES

The meetings with prospective sellers prior to the preparation of a bid or proposal to ensure all prospective vendors have a clear and common understanding of the procurement. Also called vendor conferences, pre-bid conferences, or contractor conferences.

Organizations in highly regulated industries or government

Or, if a project needs specialist work or wants to find the best quality available.

Use RFPs, **bidder conferences**, and formal processes to ensure **all prospective vendors have a clear and common understanding of the procurement**

Work closely with the procurement officer or department

Source Selection Criteria*

Work with external resources whose values, skills and attributes are aligned with your project's.



-
- Overall or life-cycle cost
 - Understanding of need
 - Technical capability
 - Management approach
 - Technical approach
 - Warranty
 - Financial capacity
 - Production capacity and interest
 - Business size and type
 - Past performance of sellers
 - References
 - Intellectual property rights
 - Proprietary rights

SOURCE SELECTION CRITERIA

A set of attributes, desired by the buyer, which a seller is required to meet or exceed to be selected for a contract.

-
- Overall or life-cycle cost
 - Understanding of need
 - Technical capability
 - Management approach
 - Technical approach
 - Warranty
 - Financial capacity
 - Production capacity and interest
 - Business size and type
 - Past performance of sellers
 - References
 - Intellectual property rights
 - Proprietary rights

Qualified Vendors

-
- Are pre-approved by the organization
 - Have a history of work with the organization
 - Are often “preferred” because they are proven, and their accounts are already set up



Look in the lessons learned repository to find historical data about vendors.

Contracts*

Negotiate Productive Relationships

Contracts:

- Legalize working agreements
- Give structure to working relationships
- Further collaboration with partners
- Consider risks associated with contract types
- Deliver benefits to the buyer - different benefits by type
- Can be tailored for the partnership

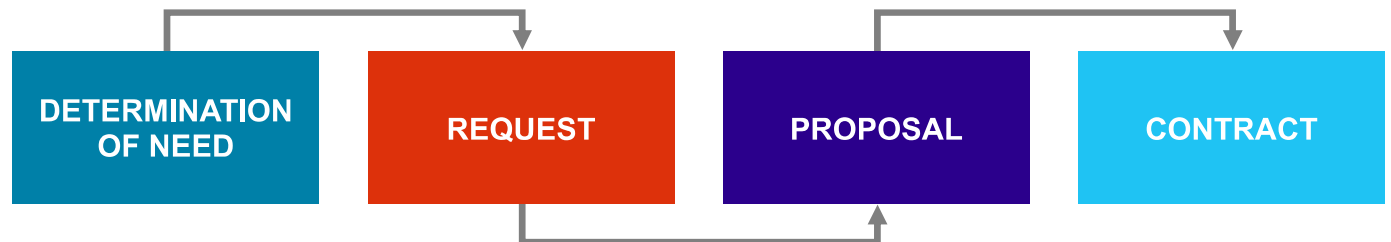

CONTRACT

A mutually binding agreement that obligates the seller (supplier) to provide the specified project or service or result and obligates the buyer to pay for it.

Contracts:

- Legalize working agreements
- Give structure to working relationships
- Further collaboration with partners
- Consider risks associated with contract types
- Deliver benefits to the buyer - different benefits by type
- Can be tailored for the partnership

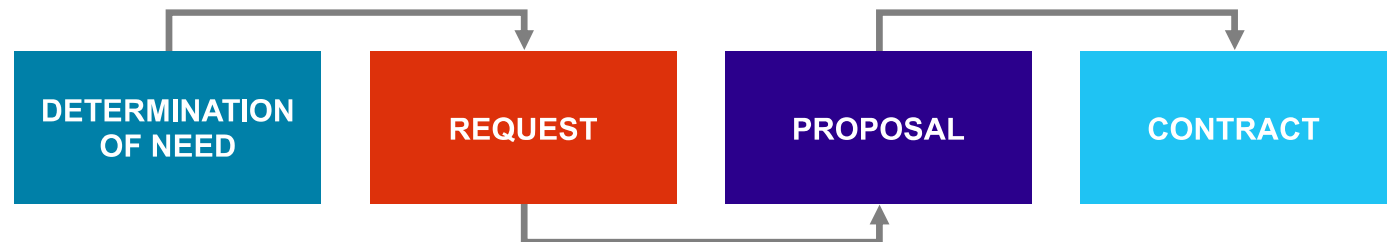

Contract Types (1 of 3)

Cost-reimbursable contracts - *For projects with expected, significant scope changes*

Involves payments (cost reimbursements) to the seller for all legitimate actual costs incurred for completed work, plus a fee (seller profit)

Cost plus fixed fee (CPFF)

- Reimburses seller for all allowable costs for performing contract work; fixed-fee payment calculated as a percentage of the initial estimated project costs.
- Fee amounts do not change unless the project scope changes.

Cost plus incentive fee (CPIF)

- Reimburses seller for all allowable costs for performing contract work; predetermined incentive fee based for achieving contract-specified performance objectives.
- Shares costs between buyer and seller if final costs are less or greater than the original estimated costs
- Bases cost sharing on a pre-negotiated cost-sharing formula — e.g., an 80/20 split over/under goal costs

Cost plus award fee (CPAF)

- Reimburses seller for all legitimate costs
- Bases majority of fee on satisfying subjective performance criteria defined and incorporated into the contract
- Determines fee based on buyer's assessment of seller performance and not subject to appeals

Contract Types (2 of 3)

Fixed-price contracts – sets a fixed total price for a defined product, service, or result; used when requirements are well defined and no significant scope changes are expected.

Firm fixed price (FFP)

Price of goods set at beginning; won't change unless scope changes

Fixed price incentive fee (FPIF)

- Gives buyer and seller flexibility
- Allows for deviation from performance — i.e., financial incentives tied to achieving agreed-upon metrics (cost, schedule, awesomeness)
- Sets price ceiling; any further costs charged to seller

Fixed price with economic price adjustments (FPEPA)

- Allows for special provisions for predefined final adjustments to the contract price — e.g., inflation, cost increases (or decreases) for specific commodities

Pre-approved vendors or international payments

Contract Types (3 of 3)

Time and materials contracts

- Also called “time and means”
- Combine aspects of both cost-reimbursable and fixed-price contracts
- Used when a precise scope or statement of work is unavailable
- Used often for augmenting staff, acquiring experts or gaining external support

“Agile” Contract Types

Multi-tiered structure	<ul style="list-style-type: none"> • Create a master service agreement to capture fixed items - e.g., warranties, arbitration • List variable items in a schedule of services - e.g., service rates, product descriptions • Use a SOW to itemize dynamic items - e.g., scope, schedule, budget
Emphasize value delivered	<ul style="list-style-type: none"> • Structure milestone and payment terms based on value derived at milestones • Focus on the value of feedback in product development
Fixed-price increments	Decompose scope into smaller, fixed-price micro-deliverables (user stories), giving customer more control over how the money is spent and limiting the supplier’s financial risk.
Not-to-exceed time and materials	<ul style="list-style-type: none"> • Limit budget to fixed amount, allowing customer to add ideas by removing existing ones • Monitor work to avoid overage (or add contingency hours)
Graduated time and materials	<ul style="list-style-type: none"> • Connect quality and timely delivery of work (use DoD) to financial award – reward for early and reduce for late delivery
Early cancellation option	<ul style="list-style-type: none"> • Enable flexible delivery of scope, using DoD - e.g., if partial scope delivery satisfies customer, contract can be cancelled for a fee
Dynamic scope option	<ul style="list-style-type: none"> • Gives option to vary scope and fund innovation at specific points while limiting supplier risk • Vary scope at specific points to adjust features and innovate
Team augmentation	<ul style="list-style-type: none"> • Embed supplier’s services directly into the customer organization; fund team instead of scope

Components of Contracts

-
- Description of work - deliverables and scope
 - Delivery date and schedule information
 - Identification of authority, where appropriate
 - Responsibilities of both parties
 - Management of technical and business aspects
 - Price and payment terms
 - Provisions for termination
 - Applicable guarantees and warranties
 - Intellectual property
 - Security, confidentiality, data privacy

ECO Coverage

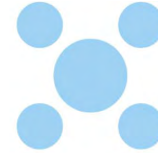

1.6 Build a team

- Deduce project resource requirements (1.6.2)

2.11 Plan and manage procurement (resources)

- Define resource requirements and needs (2.11.1)
- Communicate resource requirements (2.11.2)
- Manage suppliers/contracts (2.11.3)
- Plan and manage procurement strategy (2.11.4)
- Develop a delivery solution (2.11.5)

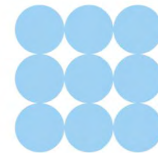
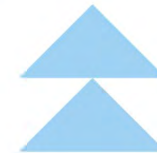



Budget

TOPIC E

Budget Planning Overview

Consider:

- Cost as well as value
- Organization and stakeholder attitudes towards budget and costs



Create budget in accordance with project life cycles:



Begin with fixed budget and amend with change control process



Hybrid approaches add adaptability around surety



Use *burn rate*



Agile teams collaborate with stakeholder partners and finance stakeholders to suggest incremental budgeting approaches (agile mindset)

BURN RATE

The rate at which the project consumes financial resources, representing negative cash flow. Burn rates are often used by agile projects to budget costs for planned iterations / sprints / increments.

Create budget in accordance with project life cycles:



Begin with fixed budget and amend with change control process



Hybrid approaches add adaptability around surety



Use *burn rate*



Agile teams collaborate with stakeholder partners and finance stakeholders to suggest incremental budgeting approaches (agile mindset)

Predictive Budget Planning

-
- Create a **cost management plan**
 - Employ **estimating techniques** to assign costs to activities
 - Tailor a **cost baseline**
 - Is used to monitor and measure cost performance throughout the project (compares with actual results)
 - Includes budget contingencies to address identified risks
 - Can be changed only through formal change control procedures

The **budget at completion (BAC)** is the highest point on the cost baseline. The BAC is the sum of all budgets established, or the value of total planned work.



COST MANAGEMENT PLAN

A component of a project or program management plan that describes how costs will be planned, structured, and controlled.

COST BASELINE

The approved version of the time-phased project budget, excluding any management reserves, which can be changed only through formal change control procedures and is used as a basis for comparison to actual results.

BUDGET AT COMPLETION (BAC)

The sum of all budgets established to provide financial support for the work to be performed.

-
- Create a **cost management plan**
 - Employ **estimating techniques** to assign costs to activities
 - Tailor a **cost baseline**
 - Is used to monitor and measure cost performance throughout the project (compares with actual results)
 - Includes budget contingencies to address identified risks
 - Can be changed only through formal change control procedures

The **budget at completion (BAC)** is the highest point on the cost baseline. The BAC is the sum of all budgets established, or the value of total planned work.

Check with Organization

Funding Limit Reconciliation

- Compare planned project expenditure against funding limits
- Align work/expenditures on the schedule to level the rate of expenditures

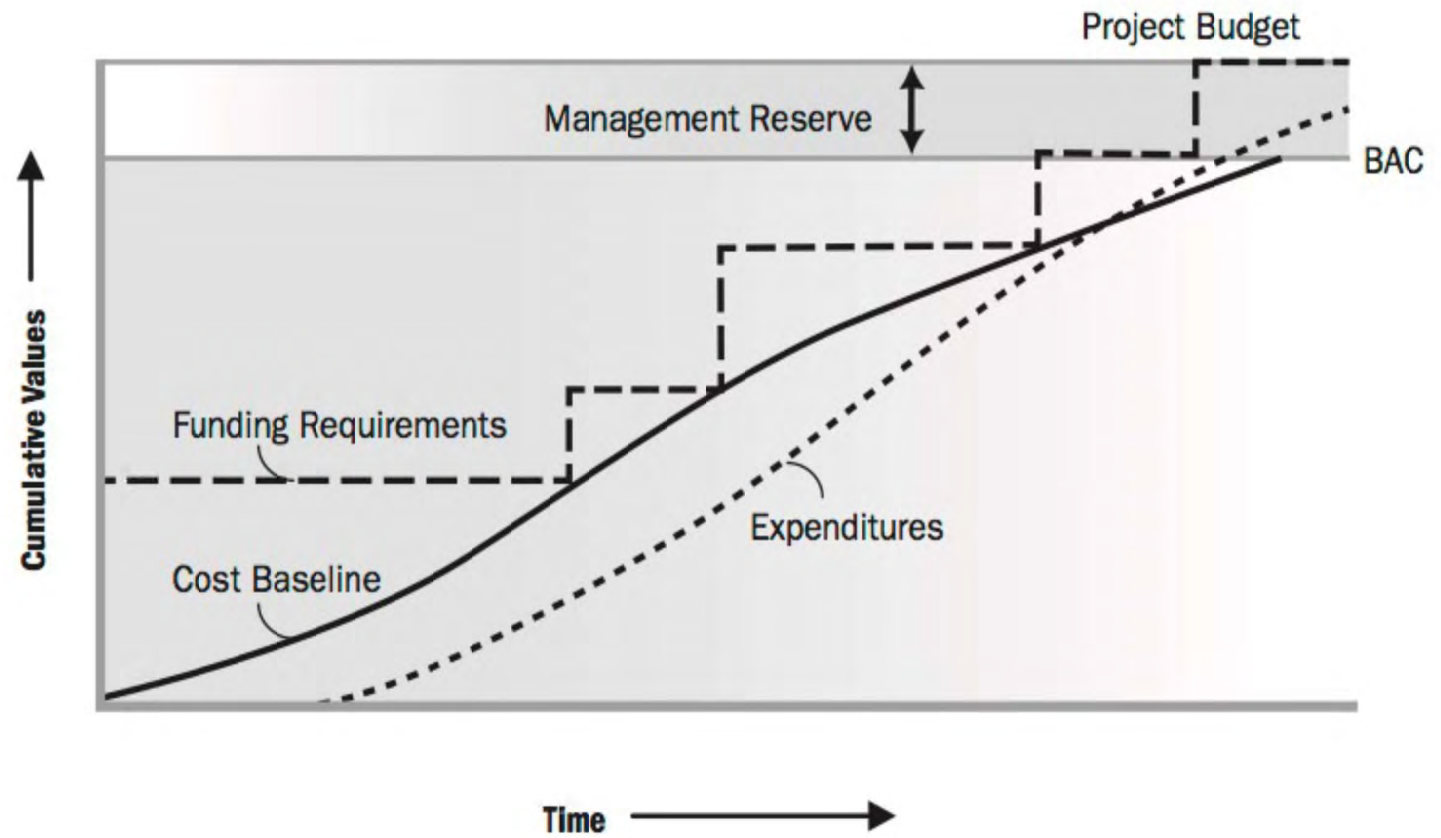

Historical Data

Start with What's Known

- Check lessons learned repository for budgets, estimates from previous, similar projects or data from the last iteration
- Look for valuable cost-estimating information - both successes and shortcomings
- Use analogous and estimating techniques, based on similar situations



Resource Costs



- Match project need to resource attributes (availability, experience, knowledge/skills, attitude)
- Create initial estimate based on average rate
- Modify as needed



- Assign a blended rate
- Estimate points (effort) using planning poker or affinity diagram to find the number of user stories that can be completed based on team velocity
- Use a simple formula to estimate the cost per point:
 - Σ (loaded team salaries for period n) / points completed in interval n
- Use a formula to estimate budget:
 - (Cost per point * total point value of items to be completed) + other expenses = forecast budget

Estimate Costs



Estimate the cost for each activity or work package in a project.

Cost estimates should include:

- Direct labor
- Materials
- Equipment
- Facilities
- Services
- Information technology
- **Contingency reserves**

Use:

- Rough order of magnitude (-25 to +75%)
- Definitive Estimate (-5 to +10%)
- Phased estimate



Expecting the scope to change?

Use lightweight estimation methods for high-level estimating.

Costs

the cost for each activity or work
in a project.

imates should include:

labor

ials

ment

ies

ces

ation technology

ngency reserves

n order of magnitude (-25 to +75%)

tive Estimate (-5 to +10%)

ed estimate



Expecting the scope to change?

Use lightweight estimation methods for
high-level estimating.

CONTINGENCY RESERVE

Time or money allocated in
the schedule or cost baseline
for known risks with active
response strategies.

Project Budget

- Use the bottom-up approach to aggregate activity costs, work package costs and cost baseline
- Include **contingencies** to support risk management

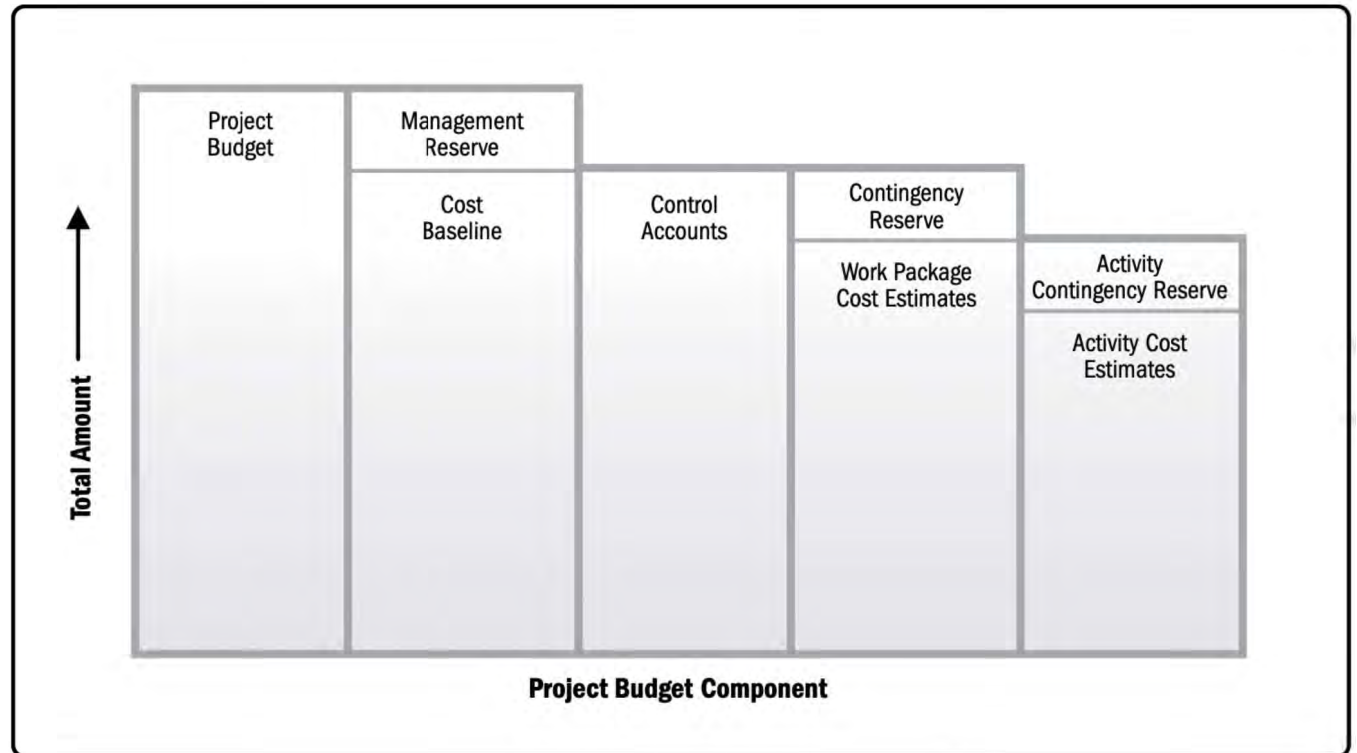

Adaptive and Hybrid Budget Planning

Guidelines/Example



- Focus on short-term budgeting and metrics versus long-term
- Set time periods for work and prioritize work within those time periods.
- Base cost on the resources used for that time period



Examples

- Estimate budget based on current data, plus a forecast algorithm that is based on historic data or expert guidance — e.g., lean or Kanban
- Use a “top-down” approach, using gross-level estimation techniques such as planning poker and affinity grouping on feature sets, then employing progressive elaboration and rolling-wave planning methods to drill down to the task level on a just-in-time basis (iteratively)
- Revise budget at sprint planning intervals

Budget Considerations



-
- Estimate budget based on the length of time of the project
 - Burn rate includes:
 - Number of team members
 - Blended or actual team member rates
 - Time of involvement
 - Assumption of full-time team involvement
 - If additional equipment or supplies are required, add them to the estimated cost



Product owner may control the budget, depending on team composition.

ECO Coverage

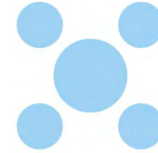

2.5 Plan and manage budget and resources

- Estimate budgetary needs based on the scope of the project and lessons learned from past projects (2.5.1)
- Anticipate future budget challenges (2.5.2)
- Plan and manage resources (2.5.4)

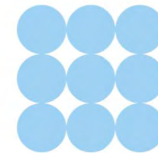
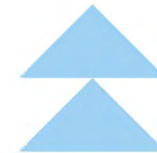



Risks

TOPIC F

Risk

Conditions of Uncertainty

-
- Risk originates from a wide range of known and unknown causes within and outside the business environment.
 - Risk development is indicated by a **trigger condition**.
 - Risks can be positive (**opportunities**) or negative (**threats**).
 - If a risk becomes an **issue**, you must act!

TRIGGER CONDITION

An event or situation that indicates that a risk is about to occur.

OPPORTUNITY

A risk that, if developed, would create a positive effect on one or more project objectives.

THREAT

A risk that would have a negative effect on one or more project objectives.

ISSUE

A current condition or situation that may have an impact on the project objectives.

-
- Risk originates from a wide range of known and unknown causes within and outside the business environment.
 - Risk development is indicated by a **trigger condition**.
 - Risks can be positive (**opportunities**) or negative (**threats**).
 - If a risk becomes an **issue**, you must act!

Project Risks

SLC Examples



Project Risks

- **Working with new vendors and building processes**
- **Supply chain issues for correct bricks**
- **Building code compliance**
- **Key stakeholder conflict**
- **Retail market changes – decline of in-store shopping**
- **Site survey shows risk of slippage from coastal erosion < 25 years**

Risk

Business Context



- *Likelihood of a risk event vs. the potential impact*
- *Opportunity vs. threat*



Business risks represent an opportunity for gain or loss.

Project risk management systematically maximizes the probability of positive events and minimizes the probability and consequences of negative events.



As project uncertainty increases, the risk of rework increases; adaptive life cycles use smaller increments of work to enable **feedback** and **progressive elaboration** of scope.

BUSINESS RISK

The inherent risk in any business endeavor that carries the potential for either profit or loss. Types of business risks are competitive, legislative, monetary, and operational.



Business risks represent an opportunity for gain or loss.

Project risk management systematically maximizes the probability of positive events and minimizes the probability and consequences of negative events.

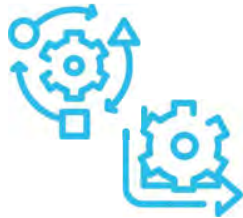

As project uncertainty increases, the risk of rework increases; adaptive life cycles use smaller increments of work to enable **feedback** and **progressive elaboration** of scope.

Create Risk Strategy

First, understand risk parameters for the organization and the project!



How would you describe the organization/ project's **risk appetite**?

- Risk-seeking?
- Risk-neutral?
- Risk-averse?

The **risk threshold** is tied to individual and organizational risk appetites. Do you know:

- Which are too high to accept?
- Which are low enough to just be accepted?



- What criteria determines inclusion in the **risk register**?

Management Guidelines

- *Use qualitative (high, medium, low, etc.) or quantitative (numerical) ratings*
- *Set a maximum risk exposure level that can be managed without escalation*

RISK APPETITE

The degree of uncertainty an organization or individual is willing to accept in anticipation of a reward.

RISK THRESHOLD

The level of risk exposure above which risks are addressed and below which risks may be accepted.

How would you describe the organization/ project's **risk appetite**?

- Risk-seeking?
- Risk-neutral?
- Risk-averse?

The **risk threshold** is tied to individual and organizational risk appetites. Do you know:

- Which are too high to accept?
- Which are low enough to just be accepted?



- What criteria determines inclusion in the **risk register**?

Management Guidelines

- *Use qualitative (high, medium, low, etc.) or quantitative (numerical) ratings*
- *Set a maximum risk exposure level that can be managed without escalation*

Define/Refine Risk Management Approach

Set initial risk strategy, then define and refine it!

Factor in project characteristics:

- Size
- Complexity
- Importance
- Development approach

Create a **risk management plan!**

In the plan:

- Risk strategy
- Methodology
- Roles and responsibilities
- Funding
- Timing
- Risk categories
- Stakeholder risk appetite
- Definition of risk probability and impact
- Probability and impact matrix
- Reporting formats
- Tracking documents



RISK MANAGEMENT PLAN

A component of the project, program, or portfolio management plan that describes how risk management activities will be structured and performed.

Set initial risk strategy, then define and refine it!

Factor in project characteristics:

- Size
- Complexity
- Importance
- Development approach

Create a **risk management plan!**

In the plan:

- Risk strategy
- Methodology
- Roles and responsibilities
- Funding
- Timing
- Risk categories
- Stakeholder risk appetite
- Definition of risk probability and impact
- Probability and impact matrix
- Reporting formats
- Tracking documents

Inherent Risk

- Agile projects include risks in user stories and as part of backlog work items
- Teams discuss risks at planning meetings, during the normal course of work
- Teams place risks in a **risk register**, use **information radiators** to ensure visibility and a **backlog refinement** process that includes constant risk assessment

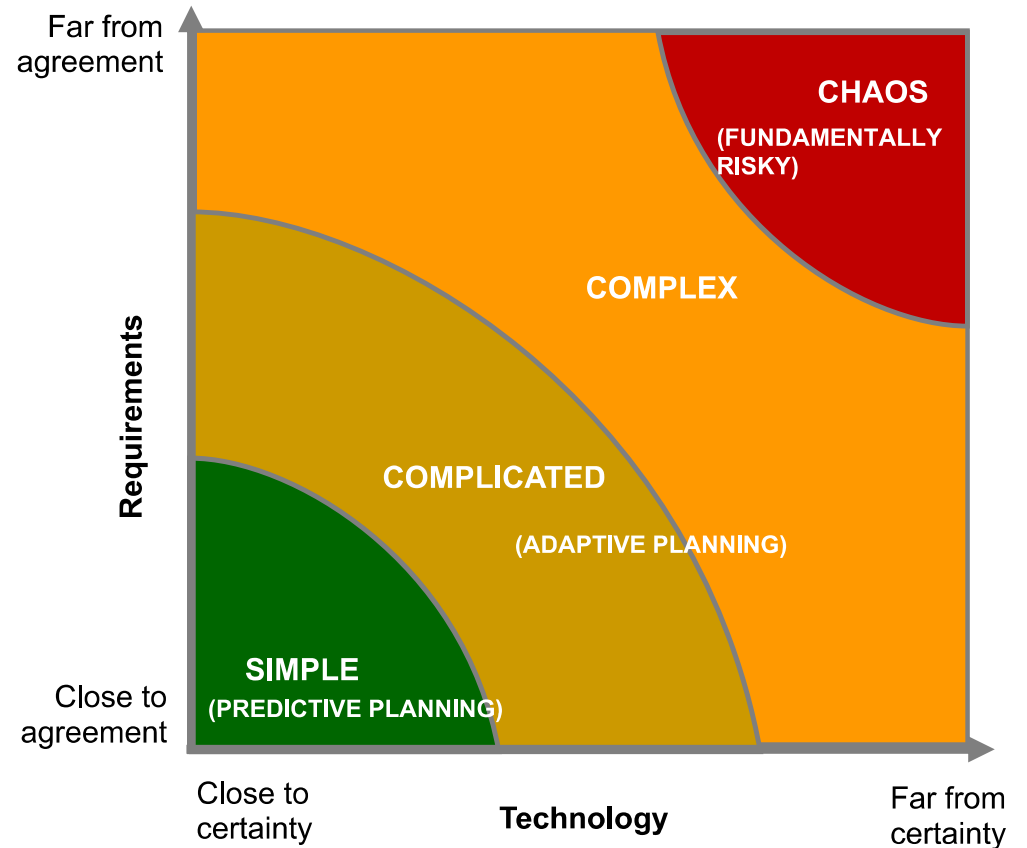

Risk Identification Techniques



Use a **prompt list** to evaluate the external environment for risks.

Data Gathering and Analysis

- Risk breakdown structure (RBS)
- Brainstorming
- Nominal group technique
- SWOT analysis
- Affinity diagram
- Assumption analysis
- Document review
- Delphi technique
- Monte Carlo simulation (larger organizations)

PROMPT LIST

A checklist for a specific category of risk. This tool is a simple series of broad risks, for example environmental or legal, rather than specific risks, such as flooding or regulatory changes. The idea is to push (prompt) the team to think and brainstorm the risks in groups and eventually prioritize the same.

RISK BREAKDOWN STRUCTURE (RBS)

A hierarchical representation of sources of risk.

AFFINITY DIAGRAM

A technique that allows large numbers of ideas to be classified into groups for review and analysis.

DELPHI TECHNIQUE

A form of gathering expert opinions in which members of a group are asked or polled anonymously.

Data Gathering and Analysis

structure

technique

- Assumption analysis
- Document review
- **Delphi technique**
- Monte Carlo simulation (larger organizations)

Identifying Project Risks



Identifying Project Risks

Spotlight Series



Let's beam our spotlight on Identifying Project Risks!

Risk Breakdown Structure

Uses typical categories, such as:

- Technical
- Management
- Commercial
- External



RBS Level 0	RBS Level 1	RBS Level 2
0. All Sources of Project Risk	1. Technical Risk	1.1 Scope definition
		1.2 Requirements definition
		1.3 Estimates, assumptions, and constraints
		1.4 Technical processes
		1.5 Technology
		1.6 Technical interfaces
	2. Management Risk	2.1 Project management
		2.2 Program/portfolio management
		2.3 Operations management
		2.4 Organization
		2.5 Resourcing
		2.6 Communication
	3. Commercial Risk	3.1 Contractual terms and conditions
		3.2 Internal procurement
		3.3 Suppliers and vendors
		3.4 Subcontracts
		3.5 Client/customer stability
		3.6 Partnerships and joint ventures
	4. External Risk	4.1 Legislation
		4.2 Exchange rates
		4.3 Site / facilities
		4.4 Environmental / weather
		4.5 Competition
		4.6 Regulatory

Example RBS

Assess Risks

Qualitative *then* Quantitative

Perform the subjective **qualitative assessment** first.

Prioritize risks for further analysis by assessing and combining their probability of occurrence and impact in a **probability/impact matrix**.

Then, if further support is required, use a **quantitative assessment**.



Not every risk needs quantitative assessment.

PROBABILITY AND IMPACT MATRIX

A grid for mapping the probability of occurrence of each risk and its impact on project objectives if that risk occurs.

Perform the subjective **qualitative assessment** first.

Prioritize risks for further analysis by assessing and combining their probability of occurrence and impact in a **probability/impact matrix**.

Then, if further support is required, use a **quantitative assessment**.



Not every risk needs quantitative assessment.

Create Risk Probability and Impact Definitions

Example

+ / - IMPACT ON PROJECT OBJECTIVES

SCALE	PROBABILITY	TIME	COST	QUALITY
VERY HIGH	>70%	>6 months	>\$5m	Very significant impact on overall functionality
HIGH	51-70%	3-6 months	\$1m-\$5m	Significant impact on overall functionality
MEDIUM	31-50%	1-3 months	\$501k - \$1m	Some impact in key functional areas
LOW	11-30%	1-4 weeks	\$100k-\$500k	Minor impact on overall functionality
VERY LOW	1-10%	1 week	<\$100k	Minor impact on secondary functions
NIL	<1%	No change	No change	No change in functionality

Probability and Impact Matrix

- Use numeric values and/or colors
- If using numbers, multiply them to give a probability impact score – this makes evaluating relative priority easier!



This is NOT a quantitative evaluation.

		IMPACT (SEVERITY)				
		1	2	3	4	5
PROBABILITY (LIKELIHOOD)	1	VERY LOW 1	2	3	4	5
	2	2	LOW 4	6	8	10
	3	3	6	MEDIUM 9	12	15
	4	4	8	12	HIGH 16	20
	5	5	10	15	20	VERY HIGH 25

Risk Register*



Risk Description	Impact Description	Impact Level Score	Probability Level Score	Risk Score <i>(probability and impact multiplied)</i>	Trigger Condition	Planned Response	Owner
	<i>What will happen if the risk is not mitigated or eliminated</i>	<i>Rate 1 (LOW) to 5 (HIGH)</i>	<i>Rate 1 (LOW) to 5 (HIGH)</i>	<i>(IMPACT X PROBABILITY) Address highest first.</i>	<i>What indicates the risk will occur.</i>	<i>Action plan</i>	<i>Who's responsible</i>
Supply chain issues for correct bricks		5	1	5	Supplier notification		L. De Souza
Building code compliance		5	2	10	Pre-checks fail		K. Ayong
Working with new vendors and building processes		3	3	9	Delays or conflict		K. Ayong



RISK REGISTER

A repository in which outputs of risk management processes are recorded. As the central planning document for project risk analysis and control, the risk register contains a list of the most important risks to the project's completion. For each risk, it identifies the likelihood of occurrence, the impact to the project, the priority, and the applicable response plans.

Item	Impact Level Score	Probability Level Score	Risk Score (probability and impact multiplied)	Trigger Condition	Planned Response	Owner
	Rate 1 (LOW) to 5 (HIGH)	Rate 1 (LOW) to 5 (HIGH)	(IMPACT X PROBABILITY) Address highest first.	What indicates the risk will occur.	Action plan	Who's responsible
	5	1	5	Supplier notification		L. De Souza
	5	2	10	Pre-checks fail		K. Ayoung
	3	3	9	Delays or conflict		K. Ayoung

Risk List



Risk	Probability (1-10)	Impact (1-10)	Magnitude
• Working with new vendors and building processes	5	6	30
• Supply chain issues for correct bricks	5	10	50
• Building code noncompliance	5	10	50
• Key stakeholder conflict (Josie Bynoe)	4	6	24
• Retail market declining	8	10	80
• Site survey shows risk of slippage from coastal erosion < 25 years	5	3	15

Teams can add (tailor) columns for:

- Owner
- Status
- Date identified
- Date resolved
- Days active
- Resolution strategy



In addition to a risk list or a risk register, teams use information radiators and a backlog refinement process with risks added, which are discussed at various planning meetings.

Quantitative Risk Analysis Methods

(1 of 2)

- Simulations
- Sensitivity analysis
- Decision tree analysis
- Influence diagrams
- Expected monetary value (EMV)



- **Simulations** - Use computer models to determine risk factors
- **Monte Carlo simulations** produce a quantitative risk analysis model by using schedule and/or cost inputs to produce an integrated quantitative cost-schedule risk analysis

- **Sensitivity analysis -**

- Output is the **Tornado diagram**, a horizontal bar chart comparing relative importance of various risks, highest on top

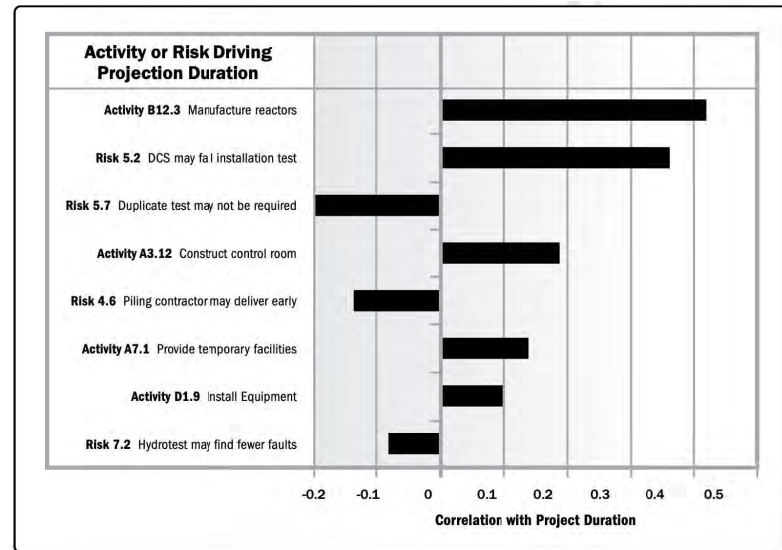

SIMULATION

An analytical technique that models the combined effect of uncertainties to evaluate their potential impact on objectives.

MONTE CARLO SIMULATION (RISK ANALYSIS)

A risk management technique, which project managers use to estimate the impacts of various risks on the project cost and project timeline. Using this method, one can easily find out what will happen to the project schedule and cost in case any risk occurs. It is used at various times during the project life cycle to get the idea on a range of probable outcomes during various scenarios.

SENSITIVITY ANALYSIS

An analysis technique to determine which individual project risks or other sources of uncertainty have the most potential impact on project outcomes, by correlating variations in project outcomes with variations in elements of a quantitative risk analysis model.

Use computer models to determine risk factors

Simulations produce a quantitative risk analysis model include and/or cost inputs to produce an integrated cost-schedule risk analysis

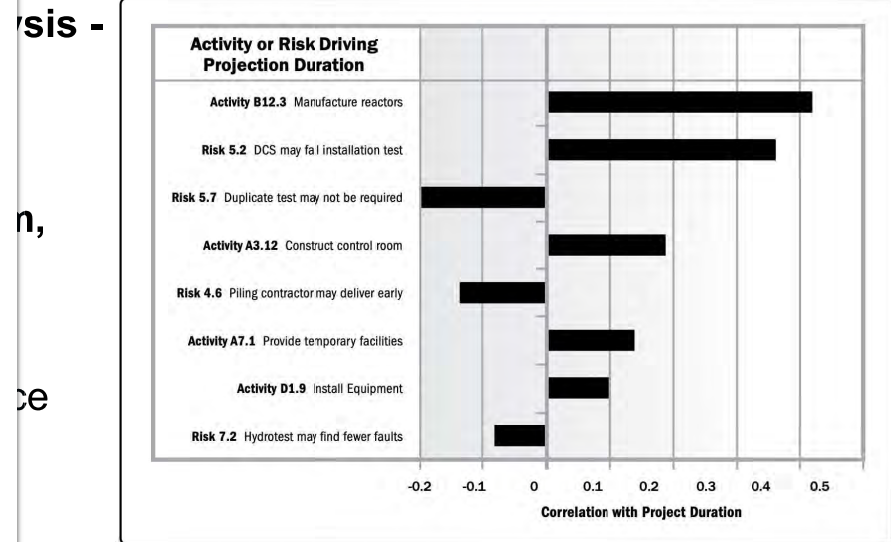

Quantitative Risk Analysis Methods

(2 of 2)

- Simulations
- Sensitivity analysis
- Decision tree analysis
- Influence diagrams
- Expected monetary value (EMV)

Decision tree analysis

- Branches represent decisions or events, each with associated costs and risks
- The end-points of branches represent the outcome (negative or positive)

Influence diagrams

- Quality management graphical aid
- Shows elements of uncertainty caused by risks using ranges or probability distributions



Used when decision trees are too complex.

Expected Monetary Value (EMV)

- Multiply the monetary value of a possible outcome with its probability of occurrence to calculate the EMV of each branch
- Select the optimal one

DECISION TREE ANALYSIS

A diagramming and calculation technique for evaluating the implications of a chain of multiple options in the presence of uncertainty.

INFLUENCE DIAGRAM

Used in quality management decisions. A graphical representation of situations showing causal influences, time ordering of events, and other relationships among variables and outcomes.

EXPECTED MONETARY VALUE (EMV)

A quantitative method of calculating the average outcome when the future is uncertain. The calculation of EMV is a component of decision tree analysis. Opportunities will have positive values and threats will have negative values.

Decision tree analysis

Nodes represent decisions or events, each with associated costs and risks
End-points of branches represent the outcome (negative or positive)

Influence diagrams

Quality management graphical aid
Identifies elements of uncertainty caused by risks using ranges or probability distributions

Used when decision trees are too complex.

Expected Monetary Value (EMV)

Used to determine the monetary value of a possible outcome with its probability of occurrence to calculate the EMV of each branch and select the optimal one

Risks

Time, Cost and Life Cycle



“Predictive projects are most often affected by the impact of cost-related risks, whereas adaptive projects are affected by the impact of time-related risks.”

 *Do you agree or disagree?
Why?*



*Do you think each of these typical risks is more typical of predictive or adaptive project?
Can you explain why?*

Typical Risks

- Delivery date slips
- Stretched resources
- Lack of clarity
- Scope creep

Risk Response

Good Practice

Risk responses should be:

- Appropriate for the significance of the risk
- Cost effective
- Realistic within the project context
- Agreed to by relevant stakeholders
- Owned by a responsible person



Plan Risk Response

Guidelines and Terminology



-
- A trigger condition signals a risk can develop
 - Team implements a risk response
 - A **secondary risk** can arise as a direct result of the risk response implementation
 - **Residual risk** can remain after risk responses have been implemented
 - Have a **contingency (fallback) plan** ready in case the primary risk response fails
 - The **contingency reserve (or allowance)** is the budget within the cost baseline that is allocated for identified risks and their response strategies

SECONDARY RISK

A risk that arises as a direct result of implementing a risk response.

RESIDUAL RISK

The risk that remains after risk responses have been implemented.

CONTINGENCY PLAN

A risk response strategy developed in advance, before risks occur; it is meant to be used if and when identified risks become reality.

CONTINGENCY RESERVE

Time or money allocated in the schedule or cost baseline for known risks with active response strategies.

- A trigger condition signals a risk can develop
- Team implements a risk response
- A **secondary risk** can arise as a direct result of the risk response implementation
- **Residual risk** can remain after risk responses have been implemented
- Have a **contingency (fallback) plan** ready in case the primary risk response fails
- The **contingency reserve (or allowance)** is the budget within the cost baseline that is allocated for identified risks and their response strategies

Risk Response Strategies

Prepare strategies for threats (negative) as well as opportunities (positive) and for individual project risks and overall project risk.



THREAT

OPPORTUNITY

ESCALATE

ESCALATE

AVOID

EXPLOIT

TRANSFER

SHARE

MITIGATE

ENHANCE

ACCEPT

ACCEPT

ECO Coverage

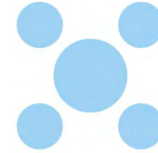

2.3 Assess and manage risks

- Determine risk management options (2.3.1)
- Iteratively assess and prioritize risks (2.3.2)

3.1 Plan and manage project compliance

- Determine necessary approach and action to address compliance needs (risk, legal) (3.1.6)
- Determine potential threats to compliance (3.1.3)

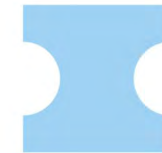
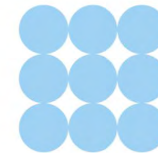



Quality

TOPIC G

Quality

The degree to which a set of inherent characteristics fulfill requirements.

Include:

- Stakeholder expectations and end-user satisfaction
- Compliance with standards and regulations
- Continuous improvement



Cost of Quality

(CoQ)

Money spent during project to avoid failure

- **Prevention costs (Build a quality product)**
 - Training
 - Document processes
 - Equipment
 - Time to do work “right” – resources, infrastructure expenses
- **Appraisal (quality assessment)**
 - Testing
 - Inspections

Money spent during/after project because of failures

- **Internal failure costs**
 - Rework
 - Scrap
- **External failure costs**
 - Liabilities
 - Warranty work
 - Lost business

Stakeholder and Customer Expectations of Quality

PRODUCT/DELIVERABLE

Identify quality requirements during requirements elicitation; create **quality management plan**.

PROCESSES

Ongoing observation and checking of processes stated in quality management plan; overseen by a **quality policy**.



*Your organization should have a **quality policy** which applies to all projects. If your organization does not have a quality policy, then your project needs to create one.*



QUALITY MANAGEMENT PLAN

A component of the project or program management plan that describes how applicable policies, procedures, and guidelines will be implemented to achieve the quality objectives.

QUALITY POLICY

The basic principles that should govern the organization's actions as it implements its system for quality management.

PRODUCT/DELIVERABLE

Identify quality requirements during requirements elicitation; create **quality management plan**.

PROCESSES

Ongoing observation and checking of processes stated in quality management plan; overseen by a **quality policy**.



*Your organization should have a **quality policy** which applies to all projects. If your organization does not have a quality policy, then your project needs to create one.*

Quality Management Plan

- Activities and resources that achieve the quality objectives
- Formal or informal, detailed or broadly framed
- Reviewed throughout the project
- Benefits:
 - Sharper focus on the project's value proposition
 - Cost reductions
 - Mitigated schedule overruns from rework

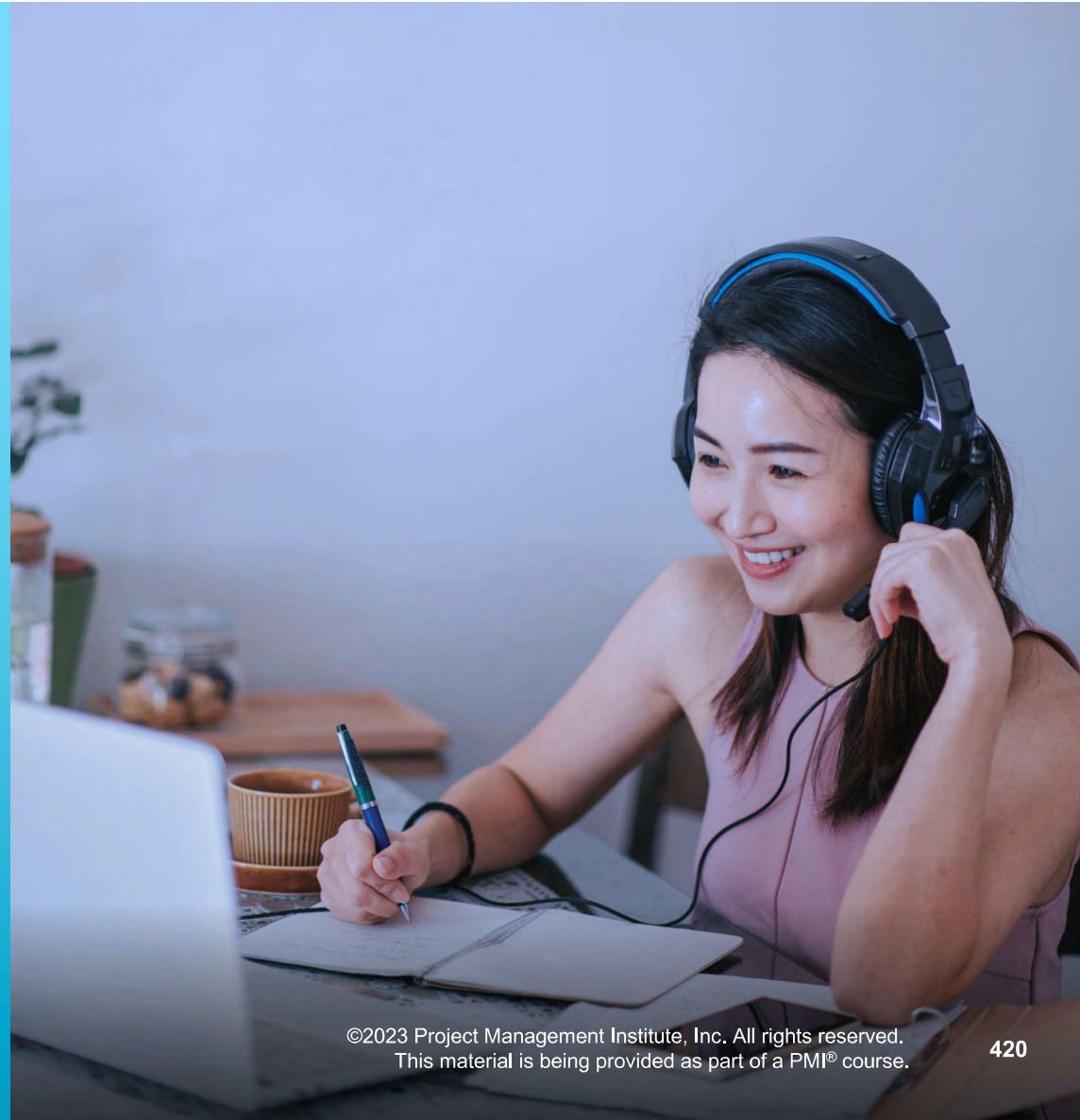

Compliance Requirements

Internal and external standards, such as:

- Appropriate government regulations
- Organizational policies
- Product and project quality requirements
- Project risk

Compliance actions:

- Classify compliance categories
- Determine potential threats to compliance
- Analyze the consequences of noncompliance
- Determine necessary approach and action to address compliance needs



Quality Standards and Regulations

		Example
Standards	Documents established as a model by an authority, custom, or by general consent.	Dictionary
Regulations	Requirements that can establish product, process, or service characteristics, including applicable administrative provisions with government-mandated compliance.	Language rules
De facto standards or regulations	Widely accepted and adopted through use, but not yet. . .	Words are used widely in groups, like slang or jargon.
De jure standards or regulations	Mandated by law or approved by a recognized body of experts.	Word enters dictionary and becomes a defined word.



A number of international institutes are devoted to quality, including:

- *American Society for Quality (ASQ) - ISO 9000 Series*
- *The Chartered Quality Institute (CQI)*
- *ASTM International*

Discussion

Quality Standards and Regulations

What standards and regulations are relevant in your industry?



Quality Metrics, Checklists, and Processes



Metrics measure desired quality attributes for your product or project through testing, use of tools, processes.

Include a tolerance level that factors in what the customer will accept and describe the desired quality level in the acceptance criteria and DoD.

Include **checklists**, **templates** and **quality artifacts** in the quality management plan.

Adaptive teams use retrospectives and small batch cycles to ensure quality.

Quality Methods for Continuous Improvement

Six Sigma (aka Lean Six Sigma) – DMAIC framework (Define, Measure, Analyze, Improve, Control) – focus on removing waste

Kaizen – “change for better/improve”

(PDCA) Plan – Do – Check – Act – Shewhart/Deming

Agile methods - Scrum, Kanban, Crystal Methods (software), etc.

ECO Coverage

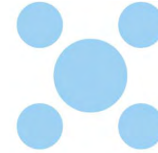

2.7 Plan and manage quality of products / deliverables

- Determine quality standard required for project deliverables (2.7.1)

3.1 Plan and manage project compliance

- Use methods to support compliance (3.1.4)
- Measure the extent to which the project is in compliance (3.1.7)

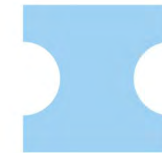
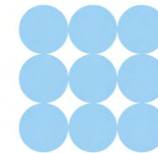



Integrate Plans

TOPIC H

Integrating Plans

An Important Step



Overall, the scope, schedule, budget, resources, quality and risk plans must support desired outcomes.

An integrated view of all plans can:

- Identify and correct gaps or discrepancies
- Align efforts and highlight how they depend on each other — so your team works better!
- Help assess and coordinate the project during its life cycle



*The result of this step is an **integrated project management plan!***

Integrate Plans



At the end of the planning stage, combine all planning results from knowledge areas.



Specific to project manager role, this task cannot be delegated.



Reframe the approach to “plan integration” and figure out a way forward to work with the various planning elements – adapt it while working!



Adaptive processes and agile ceremonies provide a structure to continuously integrate plans or aspects of a project.

Change Control

Use a **change management plan** to set a process and assigned roles for change



Questions about Change

Typical Answers

Who can propose a change?	Roles are assigned
What exactly constitutes a change?	A change is proposed or an event changes one of the project baselines or measures
What is the impact of the change on project objectives?	Recommend evaluation method
What are steps to evaluate a change request before approving or rejecting it?	Required steps per quality policy
Who has the authority to approve various types and levels of change?	Change control board, other approvals
When a change request is approved, what project documents will record the next steps (actions)?	Change log
How will you monitor these actions to confirm completion and quality?	Quality metrics, RAM/RACI charts, information radiators

CHANGE MANAGEMENT PLAN

A component of the project management plan that establishes the Change Control Board, documents the extent of its authority, and describes how the change control system will be implemented.

CHANGE REQUEST (CR)

Request for change sent to upper management or the Change Control Board (CCB) for its evaluation and approval.

Questions about Change

Typical Answers

Who can propose a change?	Roles are assigned
What exactly constitutes a change?	A change is proposed or an event changes one of the project baselines or measures
What is the impact of the change on project objectives?	Recommend evaluation method
What are steps to evaluate a change request before approving or rejecting it?	Required steps per quality policy
Who has the authority to approve various types and levels of change?	Change control board, other approvals
When a change request is approved, what project documents will record the next steps (actions)?	Change log
How will you monitor these actions to confirm completion and quality?	Quality metrics, RAM/RACI charts, information radiators

Plan for Complexity and Change

- Organization's system
- Human behavior
- Uncertainty or ambiguity



Systems-based

- **Decoupling:** Disconnect parts of the system to simplify it and reduce the number of connected variables
- **Simulation:** Use similar, unrelated scenarios to try to understand the complexity

Reframe the Problem

- **Diversity:** View the system from different perspectives
- **Balance:** Reconsider the type of data used

Process-Based

- **Iterate:** Plan iteratively or incrementally; add features one at a time
- **Engage:** Really engage with stakeholders
- **Fail safe:** Plan for failure

How to Approach Complex Plans

Fail Fast and Self-Correct!

Instead of planning, rely on **tailoring**,
adaptability and **resilience**

Adopt mindsets and frameworks that
prioritize **collaboration** over instruction
and control



ECO Coverage

2.9 Integrate project planning activities

- Consolidate the project/phase plans (2.9.1)
- Assess consolidated project plans for dependencies, gaps, and continued business value (2.9.2)
- Analyze the data collected (2.9.3)
- Collect and analyze data to make informed project decisions (2.9.4)
- Determine critical information requirements (2.9.5)

2.10 Manage project changes

- Determine strategy to handle change (2.10.2)

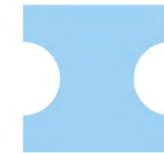
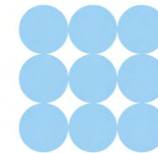
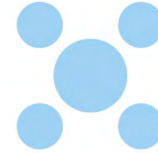

End of Lesson 3

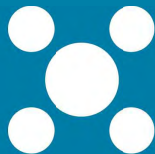

LESSON 4

LEAD THE PROJECT TEAM

- Craft Your Leadership Skills
- Create a Collaborative Project Team Environment
- Empower the Team
- Support Team Member Performance
- Communicate and Collaborate with Stakeholders
- Training, Coaching and Mentoring
- Manage Conflict

Version 3.2 | 2023 Release



Learning Objectives

- Discuss the guidelines for developing leadership competencies and skills.
 - Address leadership styles, and the components of leading a successful team, either in person or virtually.
- Describe artifacts and the strategies for their use.
- Identify the characteristics and core functions of empowered teams.
- Explain strategies and forms of communication for collaborating in a project team environment.
- Learn the value of training, coaching and mentoring for a team.
- Explain the importance of conflict management.
- Discuss the causes and levels of conflict and their outcomes.

Leading Without Authority



Leading Without Authority

Spotlight Series

In this presentation, the spotlight is on
Leading Without Authority!



Project Life Cycle Check-In

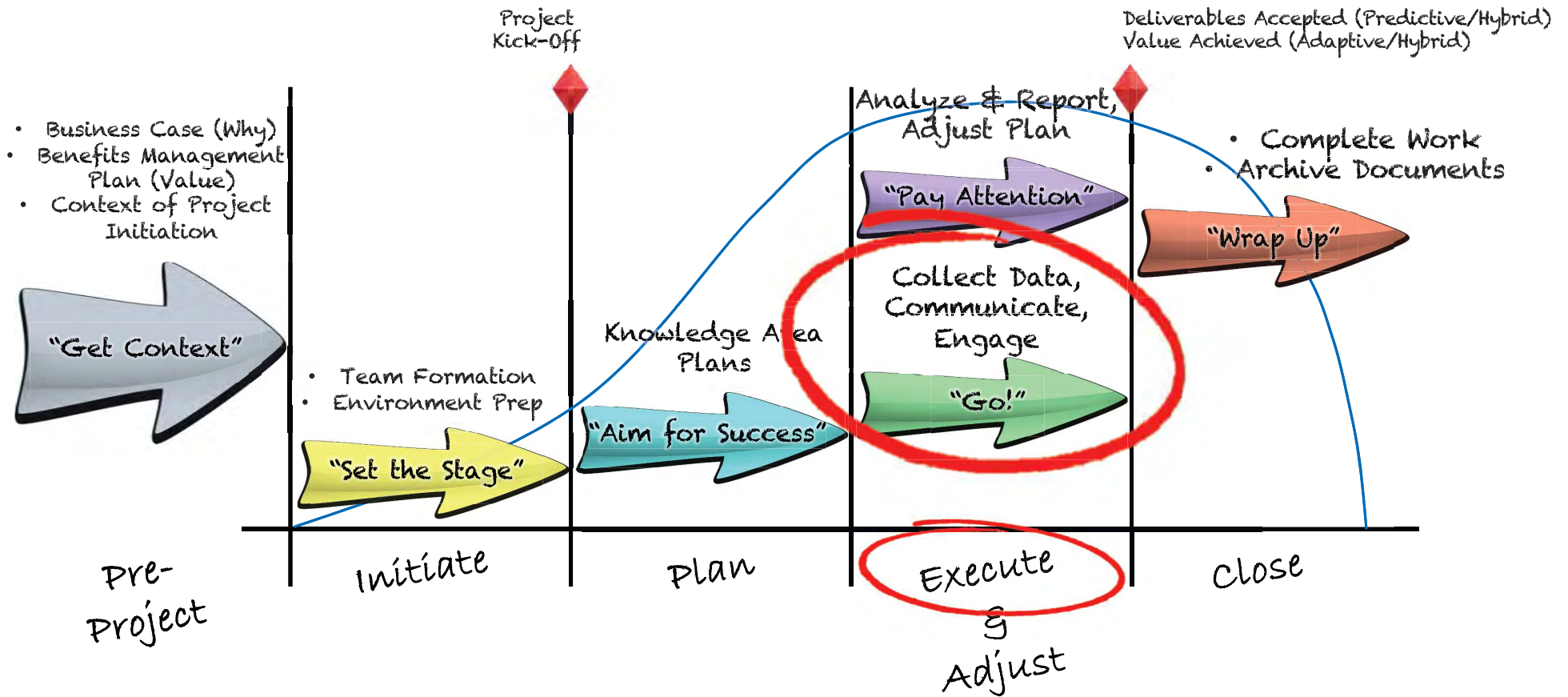



Craft Your Leadership Skills

TOPIC A

Power Skills

Project professionals use interpersonal “power skills,” including collaborative leadership, communication, an innovative mindset, for-purpose orientation and empathy.

Teams with these skills can maintain influence with a variety of stakeholders — a critical component for making change.



Guidelines for Developing Inclusive Leadership Competencies

-
- Tailor your **leadership approach and style**
 - Lead with **empathy**
 - Understand that **motivations and working styles** vary
 - Maintain **transparency** and **openness** to build trust
 - Ensure **external resources** are included

Leadership Skills & Competencies

- Communication
- Conflict management
- Critical thinking
- Cultural awareness
- Decision-making
- Emotional Intelligence Technique (EQ or EI)
- Ethical approach (PMI Code of Ethics and Professional Conduct)
- Expert judgment
- Facilitation
- Meeting management
- Negotiation
- Networking
- Team-building



Interpersonal and Team Skills

- **Active listening**
- **Communications styles assessment**
- Emotional intelligence
- Influencing
- Motivation
- Nominal group technique
- Political awareness
- Transparency



ACTIVE LISTENING

A communication technique that involves acknowledging the speaker's message and the recipient clarifying the message to confirm that what was heard matches the message that the sender intended.

COMMUNICATION STYLES ASSESSMENT

A technique to identify the preferred communication method, format, and content for stakeholders for planned communication activities.

Team

assessment



Leadership Styles

Tailoring Considerations

- Experience with project type
- Team member maturity
- Organizational governance structures
- Distributed project teams

Style	Characteristic
Direct	Hierarchical, with project manager making all decisions
Consultative	Leader factors in opinions, but makes the decisions
Servant Leadership	Leader models desired behaviors
Consensus/ Collaborative	Team operates autonomously
Situational	Style changes to fit context and maturity/experience of team

Leadership ≠ Management

Leadership - Guiding the team by using discussion and an exchange of ideas

Management - Directing actions using a prescribed set of behaviors

- Adapt leadership style to situations and stakeholders
- Be aware of individual and team aims and working relationships
- Use political awareness and emotional intelligence

Servant Leadership*

- Facilitate rather than manage
- Provide coaching and training
- Remove work impediments
- Focus on accomplishments
- Encourage every team member to be a servant leader



hip*

SERVANT LEADERSHIP

A leadership style used in agile and other types of projects which encourages the self-definition, self-discovery, and self-awareness of team members by listening, coaching, and providing an environment that allows them to grow.

age
ning
ts
ts
ember to be a



Adopt a Growth Mindset*

- Let past experiences and processes provide guidance for, but not dictate, your actions
- Commit to continuously improve and innovate, to find new ideas and perspectives
- Discover the best approach through discussion and introspection
- Avoid complacency and blind acceptance



GROWTH MINDSET

A growth mindset, as conceived by Stanford psychologist Carol Dweck and colleagues, is the belief that a person's capacities and talents can be improved over time.

processes
not dictate,

improve and
s and

ch through
ion

lind



Team-Building

- Cohesion and solidarity help teams perform better.
- Good leadership facilitates bonding between project team members.
- Team-building activities build unity, trust, empathy and focus on the team over the individual. They can be:
 - Formal or informal
 - Brief or extended
 - Facilitated by yourself or a professional facilitator



Can you share an example of a positive team-building experience?

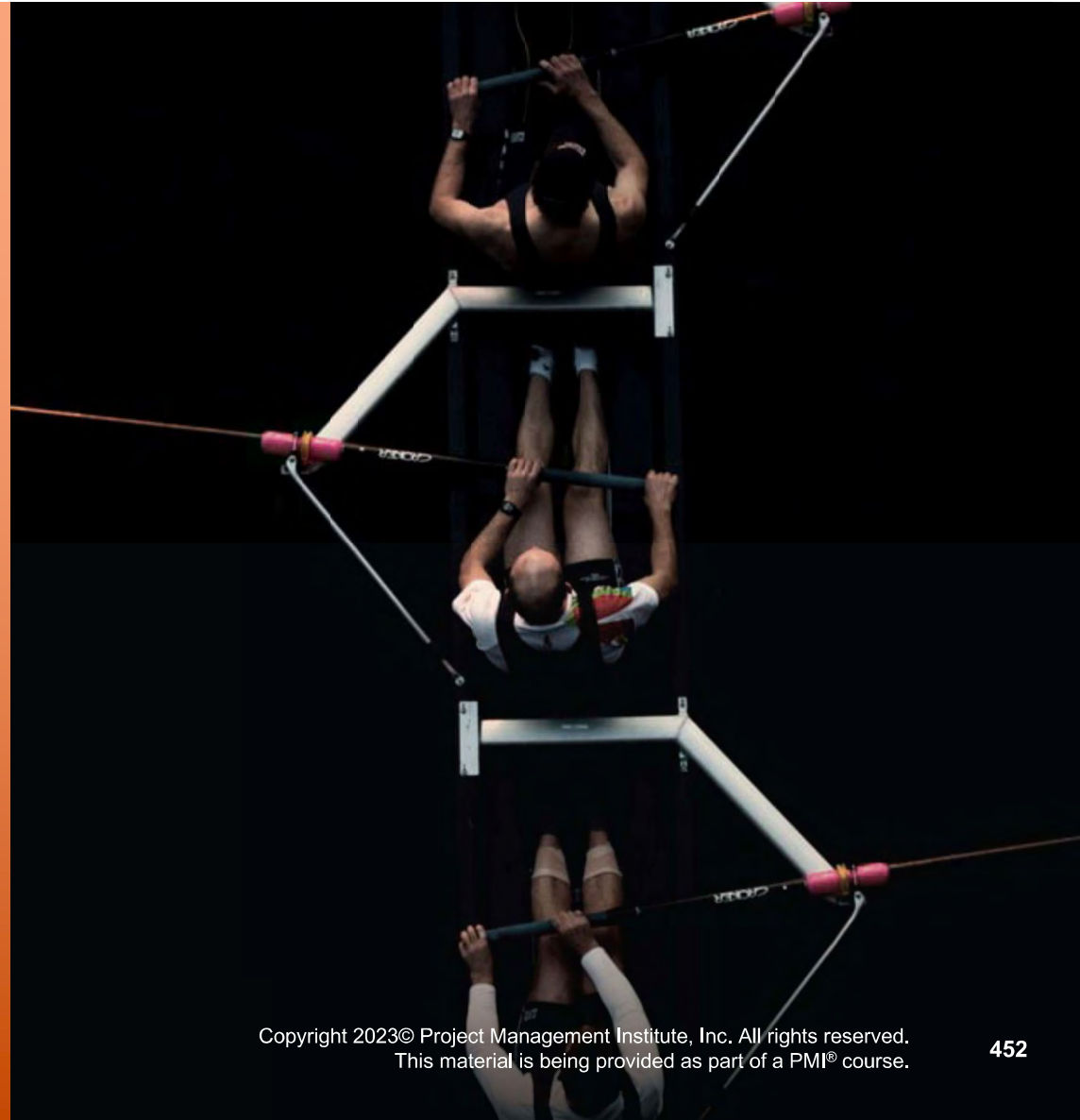

Tuckman Stages of Team Development

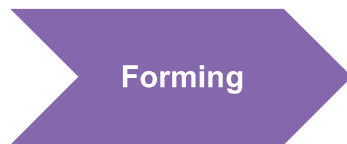

Forming

Team members meet and begin to trust one another.

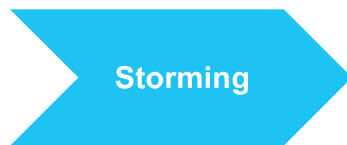

Storming

Team members begin to assert themselves and take control of emerging issues.



Norming

Team begins to work productively, without worrying about personal acceptance or control issues.



Performing

Team is working at optimum productivity and is collaborating easily, communicating freely, and solving its own conflicts.



Adjourning

Team members complete their assigned work and shift to the next project or assigned task.

Source: Dr Bruce Tuckman

Balance Team Tone with Sense of Urgency



TONE

- Use **fluid communication** and engagement
- Promote **positive interactions**

URGENCY

- Emphasize the project's vision and value
- Commit to and be accountable for delivering value
- Envision team as active participant in delivering the organization's strategic vision

Virtual Team Member Engagement

- Manage engagement by focusing on:
 - Team dynamics
 - Transparency
 - Accountability
 - Attention to effective communication
- Use and adapt videoconferencing tools
- Check for active participation, assess body language and tone
- Enable visibility of work and work status with tools (e.g., Kanban-style boards)



Virtual Team Best Practices

- Manage risk of “feeling isolated”
- Focus on shared commitments and team goals vs. individual accomplishments
- Instill a sense of shared commitment

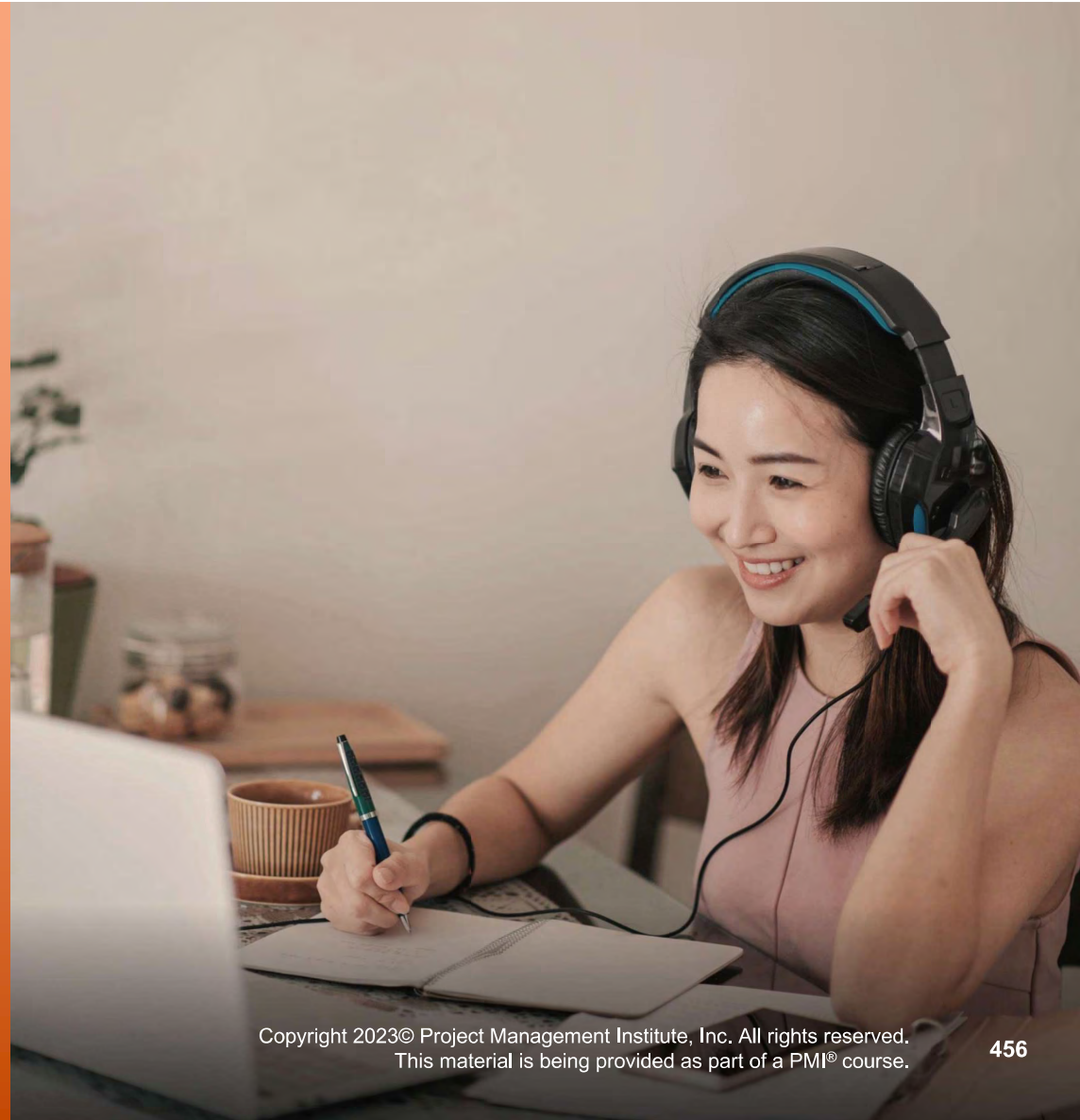

ECO Coverage

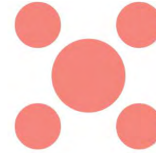

1.2 Lead a team

- Value servant leadership (e.g., relate the tenets of servant leadership to the team) (1.2.3)
- Determine an appropriate leadership style (e.g., directive, collaborative) (1.2.4)
- Distinguish various options to lead various team members and stakeholders (1.2.7)

1.11 Engage and support virtual teams

- Implement options for virtual team member engagement (1.11.3)

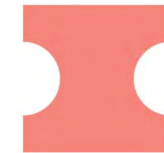
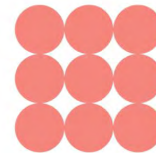
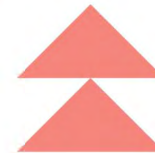



Create a Collaborative Project Team Environment

TOPIC B

Where and How the Team Works

- **Colocation**, if possible, is best!
- Factor in **environment and location** to team performance
- Foster **meaningful interaction** to support autonomy
- Respect agreed team working hours and practices (**ground rules**)



“Agile” Space for Hybrid Teams

Create a team space that encourages colocation, collaboration, communication, **transparency** and visibility



Ensure private spaces for those who need to work in solitude.



TRANSPARENCY

One of the three pillars of empirical process (transparency, inspection, and adaptability) that promotes real-time, accurate progress on every aspect of the project. See also “Visibility”.

Create a team space that encourages colocation, collaboration, communication, **transparency** and visibility



Ensure private spaces for those who need to work in solitude.

Work Information Management Systems

Project Management Information System (PMIS)

- Gather, integrate and share project data
- Ensure consistency in collection and reporting

Microsoft Project or similar



Artifacts Management Systems

Store and maintain project artifacts

- *Microsoft SharePoint or Teams*
- *Google Drive*

Importance of Artifacts



Artifacts enable reconstruction of the history of the project and to benefit other projects.



Project teams create and maintain many artifacts during the life of the project.

Information Storage and Distribution Good Practices

- Select an accessible location
- Use information radiators to make work visible
- The storage and distribution system should match the complexity of the project
- Use cloud-based systems for larger projects, especially if team members are geographically distributed



Standardize Artifacts

What to Include

- A simple way to produce and control documents
- Standardized formats and templates
- A structured process for the review and approval of documents
- Version control and security
- Timely distribution of documents



Tailor Artifacts



These lists are typical, not exclusive or prescriptive.

Tailor the artifact type and use to your project.



- Project management plan
- Project charter
- Change requests
- Scope baseline
- Schedule baseline
- Cost baseline
- Subsidiary project management plans



- Project management plan
- Product roadmap
- Task boards
- Experiments
- Product backlog
- Sprint backlog

Maintain Artifacts

Configuration management plan

- Project management plan component
- States how project information (and which items) will be recorded and updated
- Facilitates consistency of the product, service or result of the project and/or operability

Configuration management system - How a project manager tracks project artifacts and monitors, and controls changes to them

CONFIGURATION MANAGEMENT PLAN:

A component of the project management plan that describes how to identify and account for project artifacts under configuration control, and how to record and report changes to them.

CONFIGURATION MANAGEMENT SYSTEM:

A collection of procedures used to track project artifacts and monitor and control changes to these artifacts.

Configuration management plan

- Project management plan component
- States how project information (and which items) will be recorded and updated
- Facilitates consistency of the product, service or result of the project and/or operability

Configuration management system - How a project manager tracks project artifacts and monitors, and controls changes to them

Version Control*

This is a subset of configuration management related to documents and digital record keeping.

For each update, include:

- A new **version number**
- A **date/time stamp**
- **Name** of user who made the changes



Apply version control to all artifacts, especially important ones, like the project management plan.

VERSION CONTROL:

A system that records changes to a file, in a way that allows users to retrieve previous changes made to it.

This is a subset of configuration management related to documents and digital record keeping.

For each update, include:

- A new **version number**
- A **date/time stamp**
- **Name** of user who made the changes



Apply version control to all artifacts, especially important ones, like the project management plan.

ECO Coverage

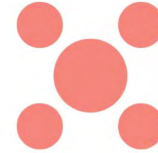

2.12 Manage project artifacts

- Determine the requirements (what, when, where, who) for managing the project artifacts (2.12.1)
- Validate that the project information is kept up to date (i.e., version control) and accessible to all stakeholders (2.12.2)

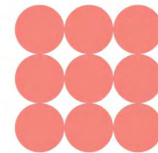
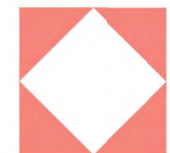
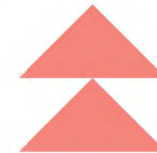



Empower the Team

TOPIC C

Empower Teams with EI and Fluid Communication

In 2016, “After years of analysing interviews and data from more than 100 teams, [Google researchers] found that the drivers of effective team performance are the group’s average level of emotional intelligence and a high degree of communication between members.”



Empowerment, Unity, Autonomy

- Empower teams to feel a sense of ownership of work, make decisions collaboratively and share responsibility
- Prioritize team unity over individual contributions
- Grant autonomy to teams to show trust, inspire and boost productivity

Goal - Team recognizes their power and influence. As an empowered, cohesive unit, they depend on each other to make decisions and solve problems to deliver desired value quickly.



©2023 Project Management Institute, Inc. All rights reserved.
This material is being provided as part of a PMI® course.

Support Diversity, Equity & Inclusion (DE&I)

- Empower teams as a cohesive unit, but respect individuals
- Create an environment that acknowledges diversity in a positive way and builds mutual trust by:
 - Following organizational or other relevant standards for DE&I
 - Supporting trust- and morale-building initiatives
 - Fostering a collaborative culture
 - Acting and leading with empathy



Create Psychological Safety and Embrace Diversity

Psychological safety is a psychosocial condition, required for high-performing project teams.

Team members should be comfortable being themselves at work.

Healthy work settings:

- Embrace **diversity**
- Are built on **trust** and **mutual respect**
- Ensure **ethical decision-making**

PSYCHOLOGICAL SAFETY

Being able to show and employ oneself without fear of negative consequences of status, career, or self-worth—we should be comfortable being ourselves in our work setting.

Psychological safety is a psychosocial condition, required for high-performing project teams.

Team members should be comfortable being themselves at work.

Healthy work settings:

- Embrace **diversity**
- Are built on **trust** and **mutual respect**
- Ensure **ethical decision-making**

Motivational Theories/ Approaches

- Maslow's Hierarchy of Needs
- Herzberg's Motivation-Hygiene Theory
- McGregor's Theory X and Y
- McClelland's Achievement Motivation Theory

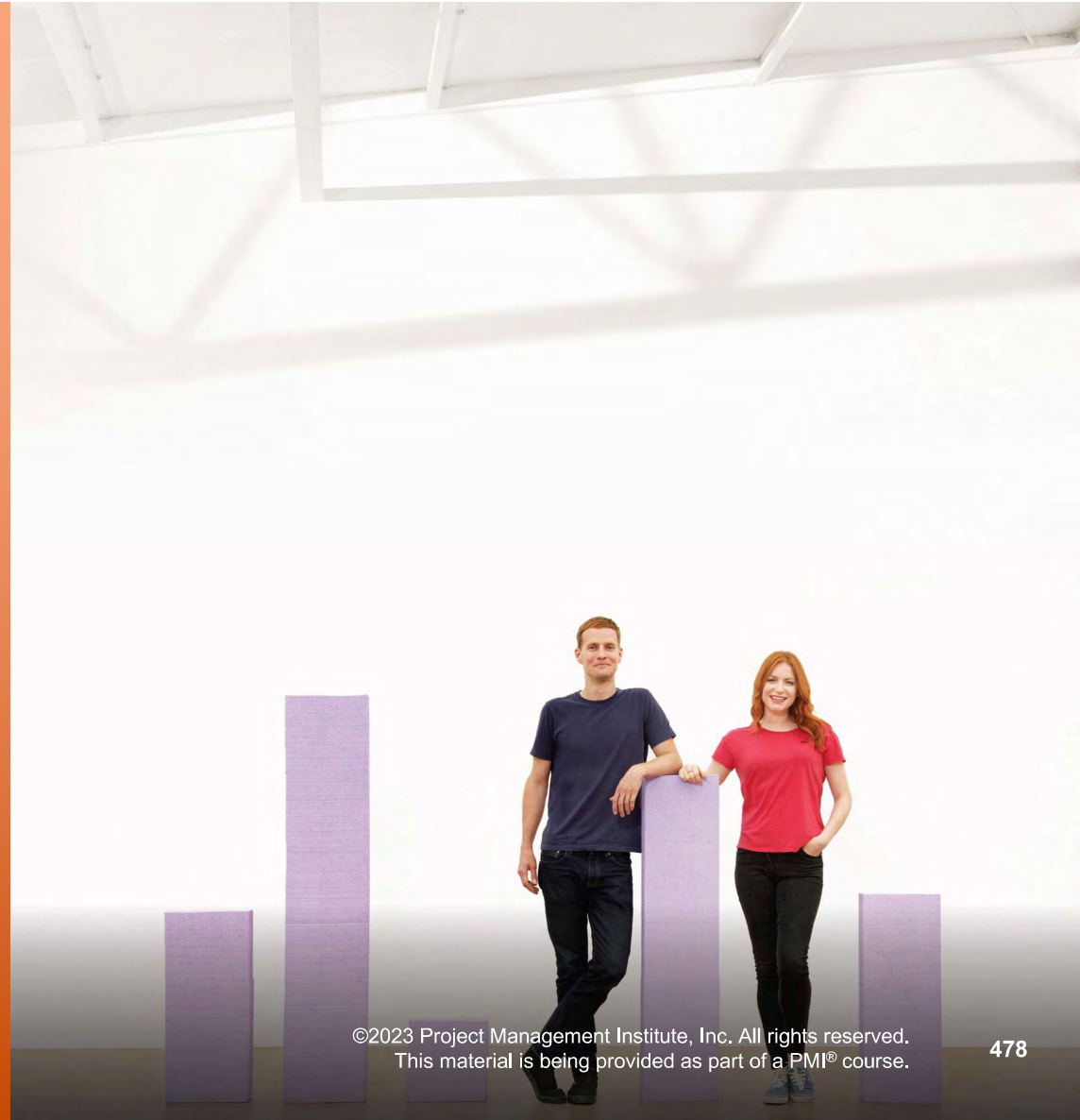

©2023 Project Management Institute, Inc. All rights reserved.
This material is being provided as part of a PMI® course.

Maslow's Hierarchy of Needs

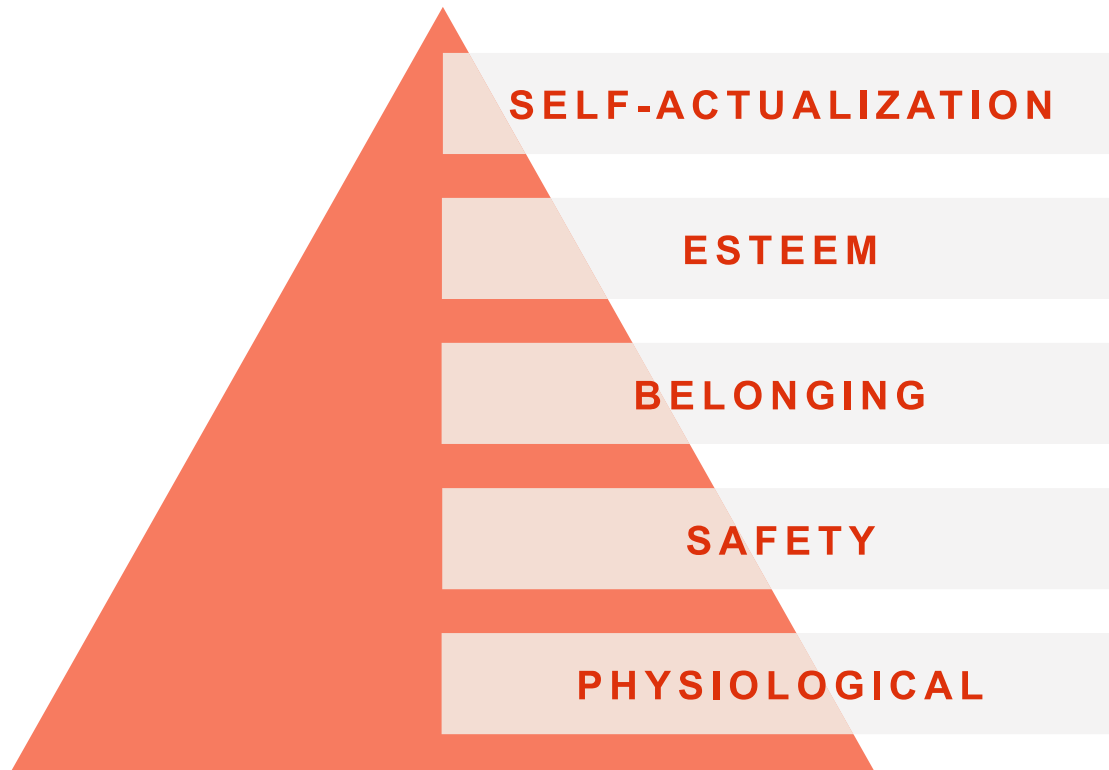

Herzberg's Motivation-Hygiene Theory

aka Two-Factor Theory

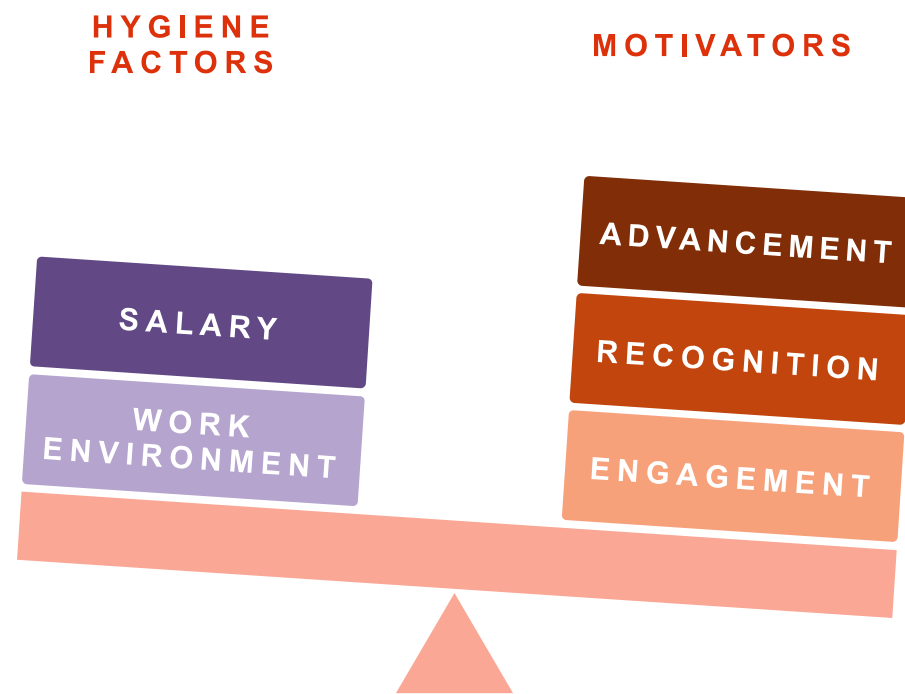

McGregor's Theory X and Theory Y



Theory X managers are often called “old-fashioned,” but can you think of a modern context in which this management style is helpful?

Theory X (authoritarian)

- Workers dislike and avoid work
- People avoid increased responsibility
- People need to be directed

Theory Y (participative)

- People want to be active
- Workers seek job satisfaction
- They do not require direction

McClelland's Achievement Motivation Theory

An individual's needs are shaped by life experiences in three areas; one becomes dominant:

- Use this information to influence goal setting, feedback and motivation/reward systems
- Design or craft roles around team member strengths
- Identify need for balance to create T-shaped people and high-performing project teams

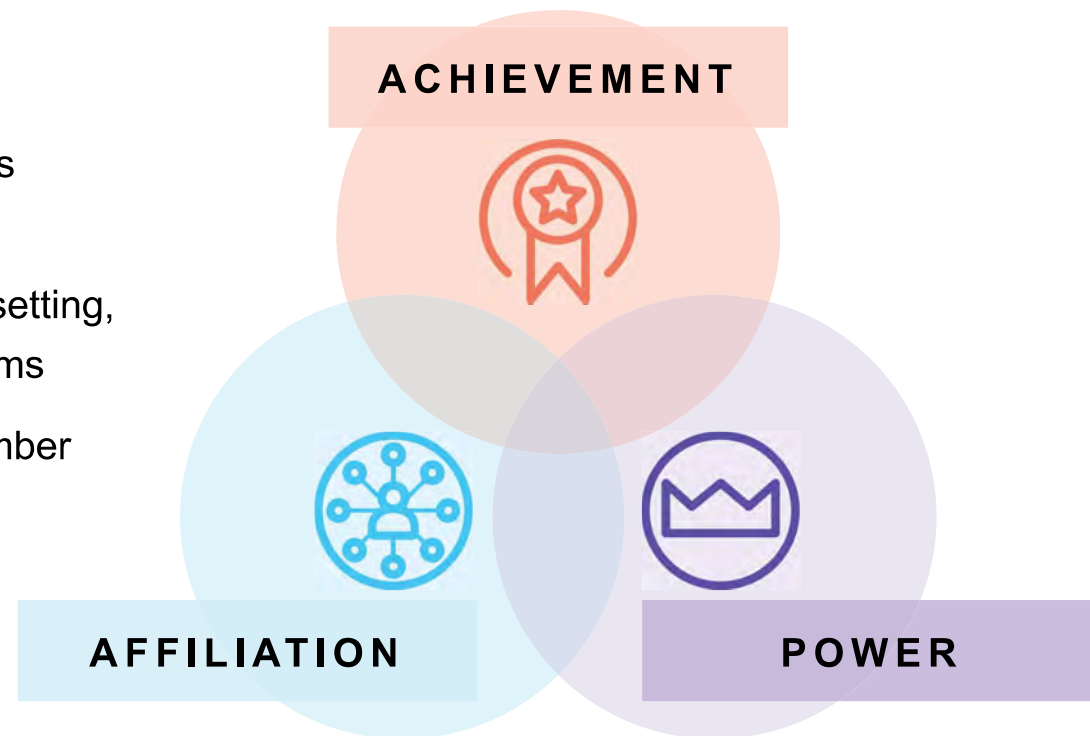

Uphold Team Charter and Ground Rules

CHECKLIST

- Are the rules visible?
- Do any rules need updating because of changing circumstances?
- Are new team members inducted properly?



Team goes through the “forming” stage after any change

- Has a ground rule been violated or broken?
 - Ensure the appropriate response
 - Remind about mutual agreement
 - Coach team members
 - Use servant leadership
 - Save harsh disciplinary action for severe violations

Use Rewards and Recognition

REWARDS

- Tangible, consumable items
- For a specific outcome or achievement
- Use to motivate toward a specific outcome
- Never reward without recognition!

RECOGNITION

- Intangible, experiential event
- Acknowledge person's behavior rather than an outcome
- Use to increase recipient's feeling of appreciation
- Can be given without a reward



Be transparent and judicious when using rewards and recognition. Monitor for any negative effects resulting from misplaced competitiveness or animosity.

Decision-Making

Empower the Team to Act

- Team charter identifies decision-making and conflict resolution criteria
- Teams establish their own norms or Way of Working (WoW) for making decisions and conflict resolution
- Teams always try to achieve **consensus**



to Act

CONSENSUS

Group decision technique in which the group agrees to support an outcome even if the individuals do not agree with the decision.

Decision-making
Criteria

Norms or Way
of Making Decisions

Have **consensus**



Decision-Making:

Opportunities to Empower the Team



Can you think of other challenges that can be addressed by team decision-making?

Activities

- Clarify and prioritize requirements or user stories
- Split requirements into tasks
- Estimate effort

Risks

- Classification
- Response/action

Decision-Making Methods

Voting

Consensus-driven, based on data

- Collective decision-making and assessment
- Determines several alternatives, with future actions as the expected outcome
- Use to generate, classify, and prioritize product requirements

Multicriteria decision analysis

Data-driven

- Method - Establish criteria in decision matrix – *e.g. risk levels, uncertainty and valuation*
- Uses a systematic, analytical approach
- Evaluate and rank many ideas

Autocratic decision making

Leadership-driven, based on data

One team member decides for the group.

Decision-Making Methods

Voting

UNANIMITY

Everyone agrees on a single course of action. Useful in project teams with great cohesion.

Example: Delphi technique

MAJORITY

Decision reached with > 50% of group support

Create groups of an uneven number of participants to ensure decisions are made and avoid tie votes/draws!

PLURALITY

Decision reached with largest block in a group deciding, even if majority is not achieved. Use this method when more than two options are nominated.



Voting methods to reach consensus

- Fist of Five
- Planning poker
- Dot voting
- Roman voting (thumbs)
- Polling

Display Task Accountability



Keep work and progress visible to demonstrate transparency of work completed.

- WBS dictionaries and work package descriptions document tasks and the assignee
- **RACI charts** display roles and responsibilities



Encourage team members to self-organize continuously in determining accountability standards.

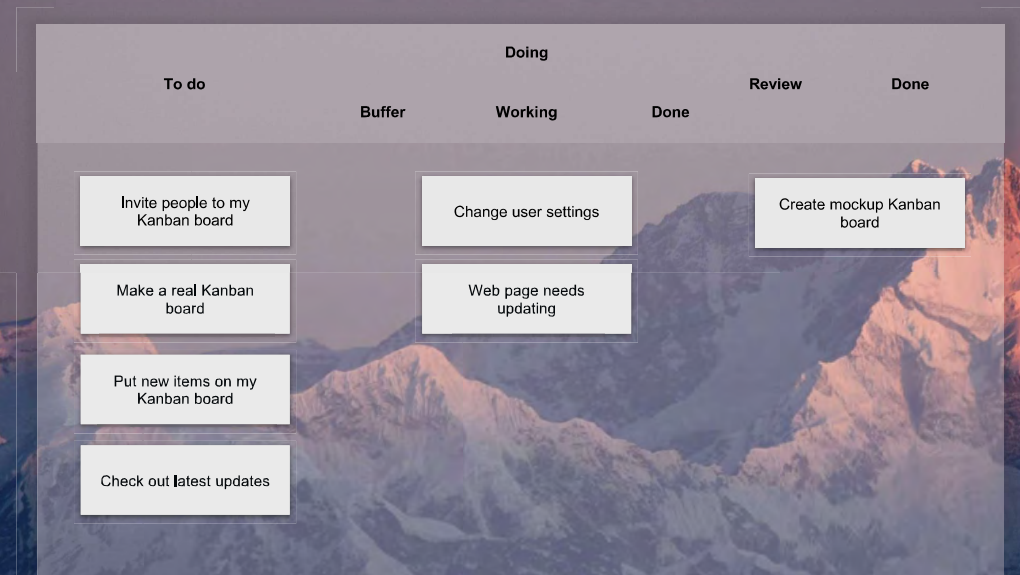

**Kanban board mockup*

ECO Coverage

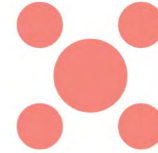

1.2 Lead a team

- Support diversity and inclusion (e.g., behavior types, thought process) (1.2.2)
- Inspire, motivate, and influence team members/stakeholders (e.g., team contract, social contract, reward system) (1.2.5)

1.4 Empower team members and stakeholders

- Determine and bestow level(s) of decision-making authority (1.4.4)

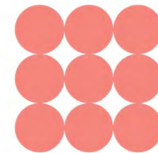
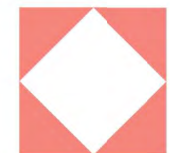
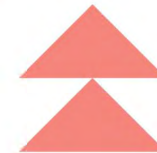



Support Team Member Performance

TOPIC D

Manage and Lead

Management by Objectives

- Uses clear objectives to guide productivity and encourage aspiration
- Set objectives collaboratively with team members
- Create challenging, yet attainable, objectives
 - At the start of a project or phase
 - Throughout the project life cycle, as in an iteration planning session

Servant Leadership

Three steps:

1. Define vision
2. Align people to that vision
3. Motivate people to pursue the vision

Assess Team Member Performance to...

- Identify **strengths, weaknesses, aspirations** and **preferences**
- Discover opportunities for **improvement**



-
- Use formal and informal assessment methods
 - Conduct assessments when team members join and then monitor progress



-
- Self-organized agile teams in psychologically safe environments assess and regulate their own performance.
 - The focus is the team, rather than individuals.

Performance Assessment Tasks

- Compare performance to goals
- Reclarify roles and responsibilities
- Deliver positive as well as negative feedback
- Discover unknown or unresolved issues
- Create and monitor individual training plans
- Establish future goals

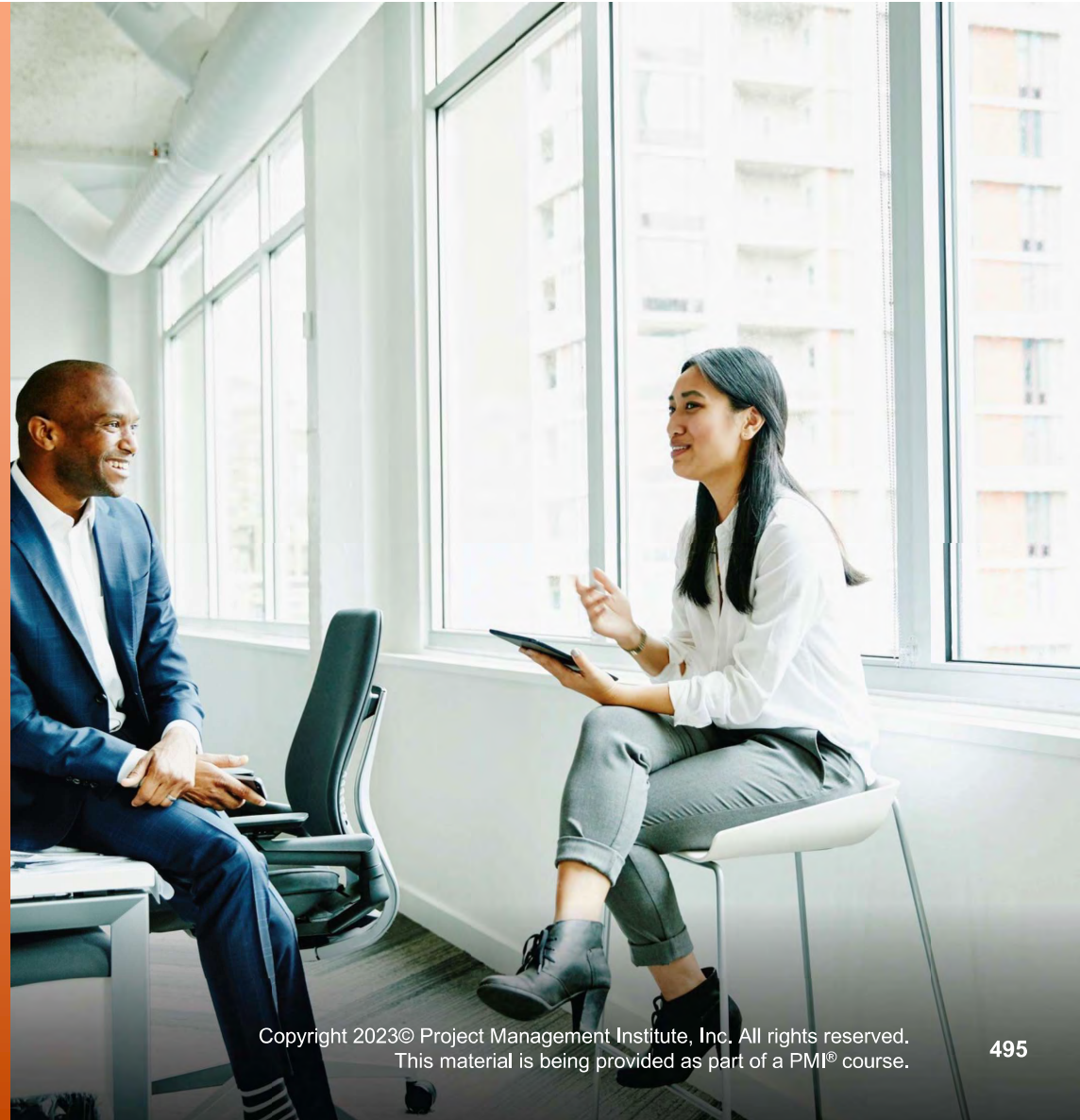

Personality Indicators

Look Beyond Introvert / Extrovert



Commonly used Measurement Tools

- Big Five Personality Model (OCEAN)
- Myers-Briggs Type Indicator
- DISC

DO

- Use the exercise as an ice-breaker or team-building activity
- Use results as predictors, not absolutes
- Always seek permission and explain use

DON'T

- Make fixed assumptions or judgments based on results
- Share anyone's personal information without permission

Use Personality Research to Coach Team Members



(Optional)

Using this list of psychological team roles, which types of project tasks or process roles would you associate them with?

Personality can affect:

- What role you have within the team
- How you interact with the rest of the team
- Whether your values (core beliefs) align with the team's

Psychological team roles:

- Results-oriented
- Relationship-focused
- Innovative and disruptive thinkers
- Process and rule-followers
- Pragmatic

Emotional Intelligence

Five main components:



Emotional self-awareness



Self-regulation



Motivation



Empathy



Social skills

Emotional Intelligence: Overview

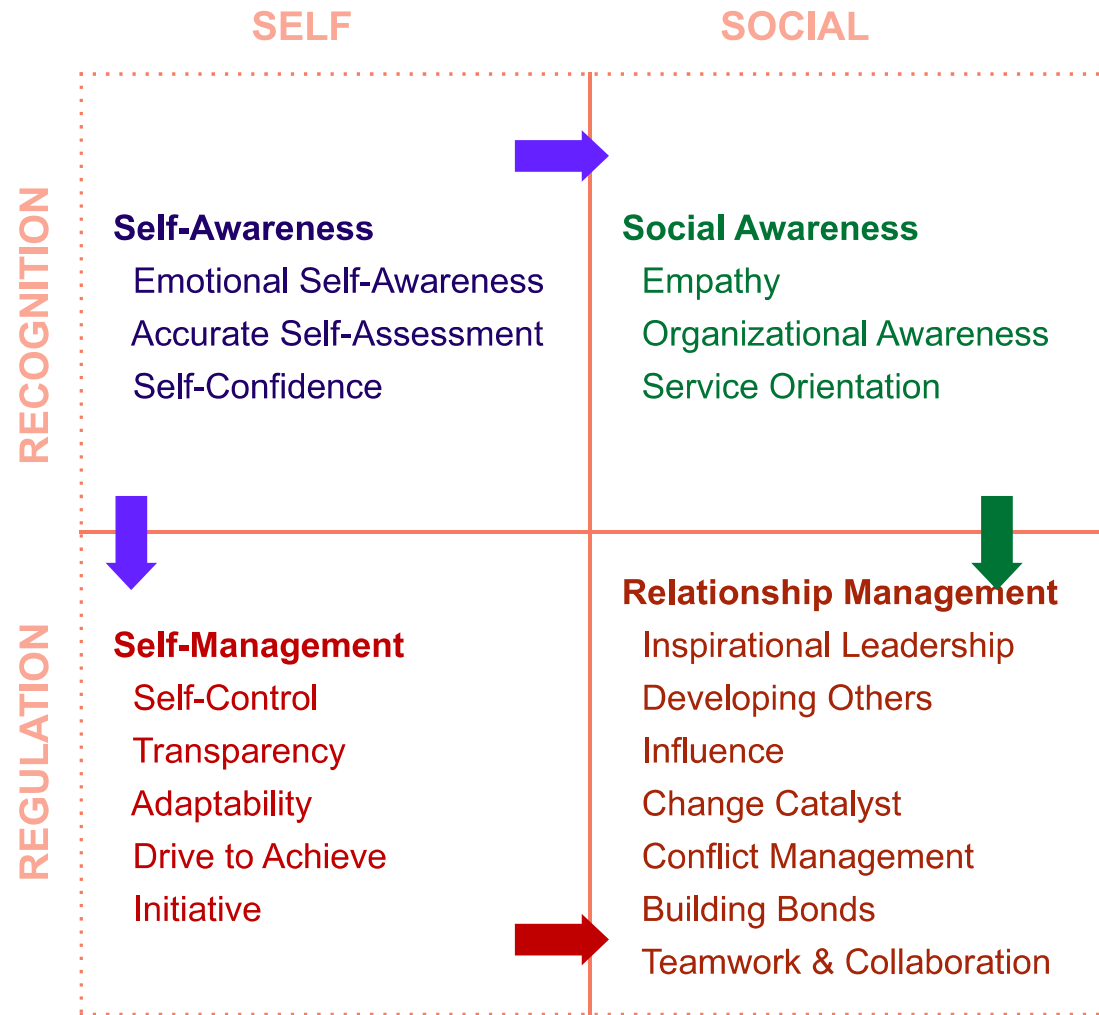

Empathy*

Provides a foundation for understanding the motivations of other people.

Empathetic traits that make individuals more able to contribute to collaborative, high-performing teams:

Inward (helps individuals)

- Understanding of others
- Service orientation

Outward (helps teams)

- Develop others
- Leverage diversity
- Have political awareness



Copyright 2023© Project Management Institute, Inc. All rights reserved.
This material is being provided as part of a PMI® course.

EMPATHY

Part of emotional intelligence (EQ or EI). The ability to understand others' viewpoints and be a team player. It enables us to connect with others and understand what moves them.

Understanding the

Individuals more
e, high-

d
(teams)

Help others
Encourage diversity
political
ness



Social Skills

High-performing team members are adept at:

- Communicating
- Building bonds
- Collaboration and cooperation
- Catalyzing change
- Managing conflict
- Influencing
- Leadership



Copyright 2023© Project Management Institute, Inc. All rights reserved.
This material is being provided as part of a PMI® course.

Motivation Elements



Achievement/Drive

- Set tough goals, take chances
- Strive for success
- Discover how to upskill
- Minimize uncertainty



Commitment

- Make decisions based on team core principles
- Realize benefits of holistic participation
- Sacrifice to fulfill company goal
- Search for opportunities to achieve team mission



Initiative

- Work hard toward goals
- Inspire others through extraordinary feats
- Seize opportunities



Optimism

- Hope to succeed; don't fear failure
- Perceive reversals as under your control
- Work toward goals regardless of barriers

ECO Coverage

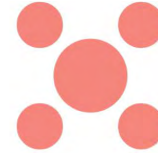

1.3 Support team performance

- Appraise team member performance against key performance indicators (KPIs) (1.3.1)
- Support and recognize team member growth and development (1.3.2)
- Determine appropriate feedback approach (1.3.3)
- Verify performance improvements (1.3.4)

1.14 Promote team performance through the application of emotional intelligence

- Assess behavior through the use of personality indicators (1.14.1)
- Analyze personality indicators and adjust to the emotional needs of key project stakeholders (1.14.2)

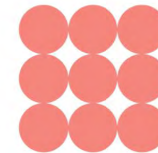
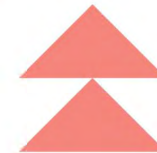



Communicate and Collaborate with Stakeholders

TOPIC E

“Communication is the real
work of leadership.”

- Nitin Nohria
*Dean of the Harvard Business
School, 2010-2020*

Monitor Stakeholders and Their Engagement

- Update grids at key intervals
- Use analysis and expert judgment
- Keep a record of the reasons for placement to enable needed change or improvement
- Tailor management strategies and actions to individuals, in addition to their place in the grid



Never use names on power/influence or power/interest grids.

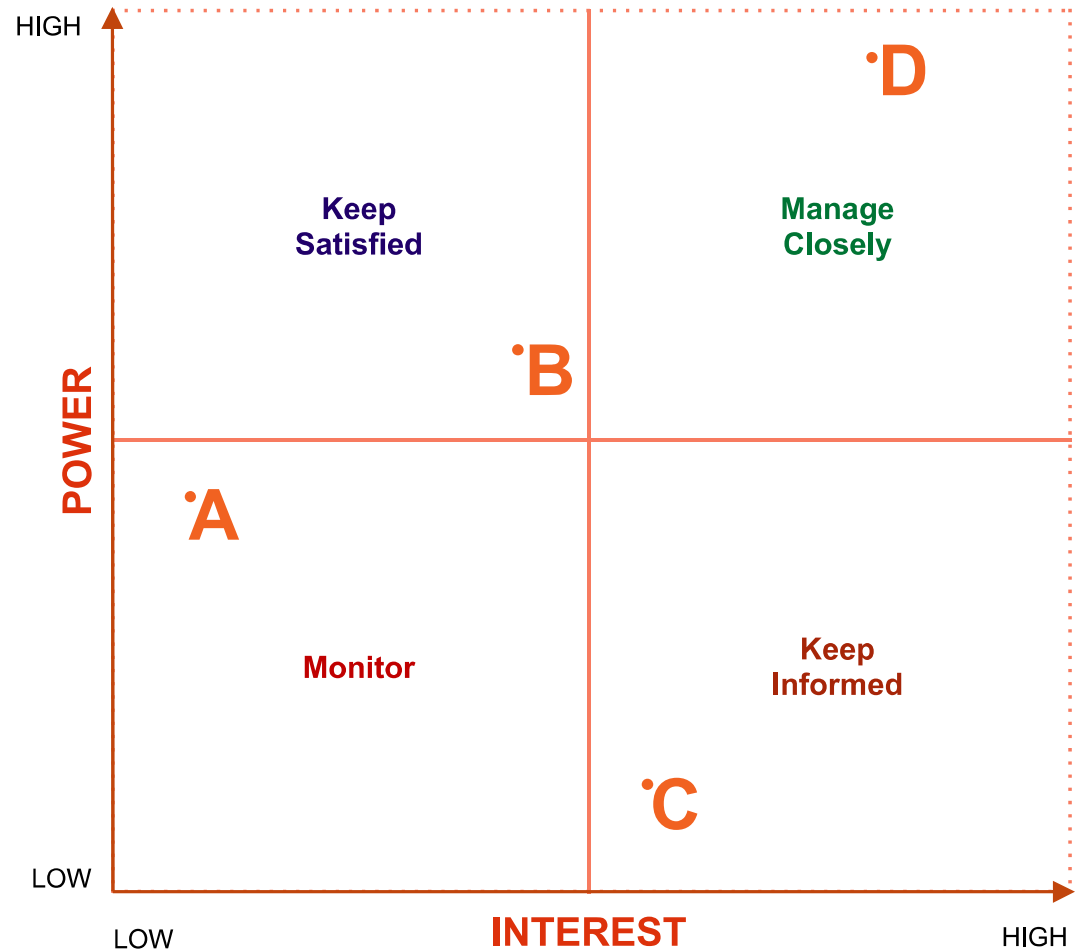

Communications Management Plan



- Identifies team members and stakeholders as:
 - Senders
 - Receivers
 - Authorizing person (confidential information)
- Lists stakeholders' communication requirements, including:
 - Type of information
 - Reason for communication
 - Language, format, content and level of detail
 - Time frame and frequency
 - Whether receipt/ acknowledgment or response is required
- Processes/guidance/templates for:
 - Escalation
 - Updating/refining the plan
 - Running project status meetings, project team meetings, sending emails, using website and PMIS
- Project information:
 - Communications methods/technologies to use
 - Allocated resources (time and budget)
 - Glossary
 - Flow charts, workflows, list of reports, meeting plans
 - Constraints

Managing Project Communications: Communications Matrix



Abbreviation of communications management plan that includes:

- Identified team members and stakeholders as:
 - Senders
 - Receivers
 - Authorizing person (confidential information)
- Stakeholder communication requirements:
 - Type of information
 - Reason for communication
 - Language, format, content and level of detail
 - Time frame and frequency
 - Whether receipt/ acknowledgment or response is required
- Processes/guidance/templates for **escalation**
- Project information - **Communications methods/technologies** to use

Communication: Two Ways

Active Listening

- Enables collaboration
- Requires listener to provide feedback about what they heard by:
 - Re-stating
 - Paraphrasing
 - Using body language such as nodding the head
- Confirms understanding and builds trust



- *Consider lack of feedback as an implicit acceptance of the message by the receiver.*
- *Communication failures are threats to projects, so discuss communications issues openly with team members directly, during team retrospectives. In the case of key stakeholders, you might need to escalate as appropriate.*

Effective feedback is:

- Clear, specific and offered in a timely manner
- Objective and critical
- Positive if received and understood as objective
- Negative if misunderstood or there is a lack of trust and psychological safety.

Reports and Formal Communication



Can you think of some examples?



Formal reporting at appropriate milestones is a proven way of maintaining continuous communication with stakeholders.

It's also needed to obtain “sign-off” or approval on work.

Recipients of reports and the desired frequency are noted on the **stakeholder engagement plan** and the **communications management plan**.

How to Collaborate

-
- Optimize understanding of aims and expectations through open dialogue and meaningful communication
 - Engage continuously
 - Accept that engagement levels may fluctuate
 - Keep discussions transparent
 - Ensure stakeholders are knowledgeable and expectations are set
 - Leverage communication and interpersonal skills, feedback and meeting management
 - Maximize the feedback loop – gain meaningful insights
 - Use effective tools – e.g., shared whiteboards

Handling Pressure from Outside Your Team



Handling Pressure from Outside Your Team

Spotlight Series

This presentation will spotlight Handling Pressure from Outside Your Team!



Use Information Radiators

Keep Information Visible

- Kanban boards
- White boards
- Wikis
- Fishbowl windows

Information radiators enable open communication and collaboration.

They can be electronic or physical, or both.

Secondary benefit is innovation — to provoke conversation and collaboration when stakeholders visit the workspace

Main benefit is accountability — promoting responsibility among team members

Radiators sible

INFORMATION RADIATOR

The generic term for visual displays placed in a visible location so everyone can quickly see the latest information. Also known as “Big Visible Chart” in agile.

Information radiators enable open communication and collaboration.

They can be electronic or physical, or both.

Secondary benefit is innovation — to provoke conversation and collaboration when stakeholders visit the workspace

Main benefit is accountability — promoting responsibility among team members

Collaboration Activities

-
- Daily stand-up meetings
 - Colocated or face-to-face working
 - Scheduled sessions — e.g., milestone reviews, backlog refinement sessions, project update meetings
 - Pairing or coaching, as in knowledge transfer
 - Negotiations

Communicate and Collaborate to Negotiate

- Think of **negotiations as conversations** with internal and external parties toward reaching agreements.
- Use **effective communication methods** to ensure collaboration with the other party is aimed at reaching consensus.
- Keep negotiations **positive** to increase the likelihood of success.



Copyright 2023© Project Management Institute, Inc. All rights reserved.
This material is being provided as part of a PMI® course.

Meetings

Everyone's time is **valuable**. Run and participate in meetings **efficiently**.

- Be **organized!** Provide a clear agenda with purpose and desired outcomes
- **Timebox** discussions
- Practice **active listening** and **feedback**
- Facilitate **collaboration**



Stakeholder Engagement Assessment Matrix (SEAM)



-
- Use **expert judgment, emotional intelligence, and interpersonal skills** to assess stakeholders
 - Update the SEAM regularly and often



Engage stakeholders by category to coach them and find solutions!

ECO Coverage

2.2 Manage communications

- Communicate project information and updates effectively (2.2.3)
- Confirm communication is understood and feedback is received (2.2.4)

1.2 Lead a team

- Analyze team members' and stakeholders' influence (1.2.6)

2.4 Engage stakeholders

- Engage stakeholders by category (2.4.3)

1.9 Collaborate with stakeholders

- Optimize alignment between stakeholder needs, expectations, and project objectives (1.9.2)
- Build trust and influence to accomplish project objectives (1.9.3)

3.2 Evaluate and deliver project benefits and value

- Appraise stakeholders of value gained by the project (3.2.5)

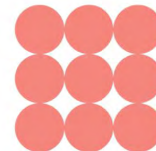
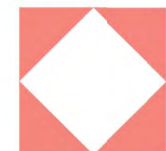
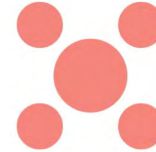



Training, Coaching and Mentoring

TOPIC F

Foster a Knowledge-Sharing Culture

Training, coaching, and mentoring are all forms of knowledge-sharing that advance projects and organizations.

- Team members learn from **and** teach others
- It's **for everyone**, including stakeholders, team members, and customers as part of project work and **continuous improvement** efforts
- Some **project roles** are dedicated to knowledge-sharing — e.g., **agile coaches** or scrum masters
- It's essential in **product delivery** and **transition planning!**

AGILE COACH

A process role on a project team that helps organizations achieve true agility by coaching teams across the enterprise on how to apply agile practices and choose their best way of working. See also “scrum master.”

Training, coaching, and mentoring are all forms of knowledge-sharing that advance projects and organizations.

- Team members learn from **and** teach others
- It’s **for everyone**, including stakeholders, team members, and customers as part of project work and **continuous improvement** efforts
- Some **project roles** are dedicated to knowledge-sharing — e.g., **agile coaches** or scrum masters
- It’s essential in **product delivery** and **transition planning!**

Training, Coaching and Mentoring

Descriptions

Training	Learn skills for use in the present	<ul style="list-style-type: none">• Individually or as a group• aka “upskilling”• On any topic
Coaching	Learn how to apply new skills or improve existing ones	<ul style="list-style-type: none">• Individually or as a group• Puts learning into practice
Mentoring	Development of personal and professional growth through long-term professional relationships.	<ul style="list-style-type: none">• Between a novice and a more experienced person• Internal or external to projects or organizations

How to Acquire Required Competencies

- Discover current skill sets and competencies
- Identify what's desired
- Take action!
 - Meet unique needs — e.g., topics, depth, schedule, format
 - Coach on the customer's business, culture, desired outcomes, and project context
 - Encourage mentorships



Use and update the SEAM to facilitate easier collaboration.

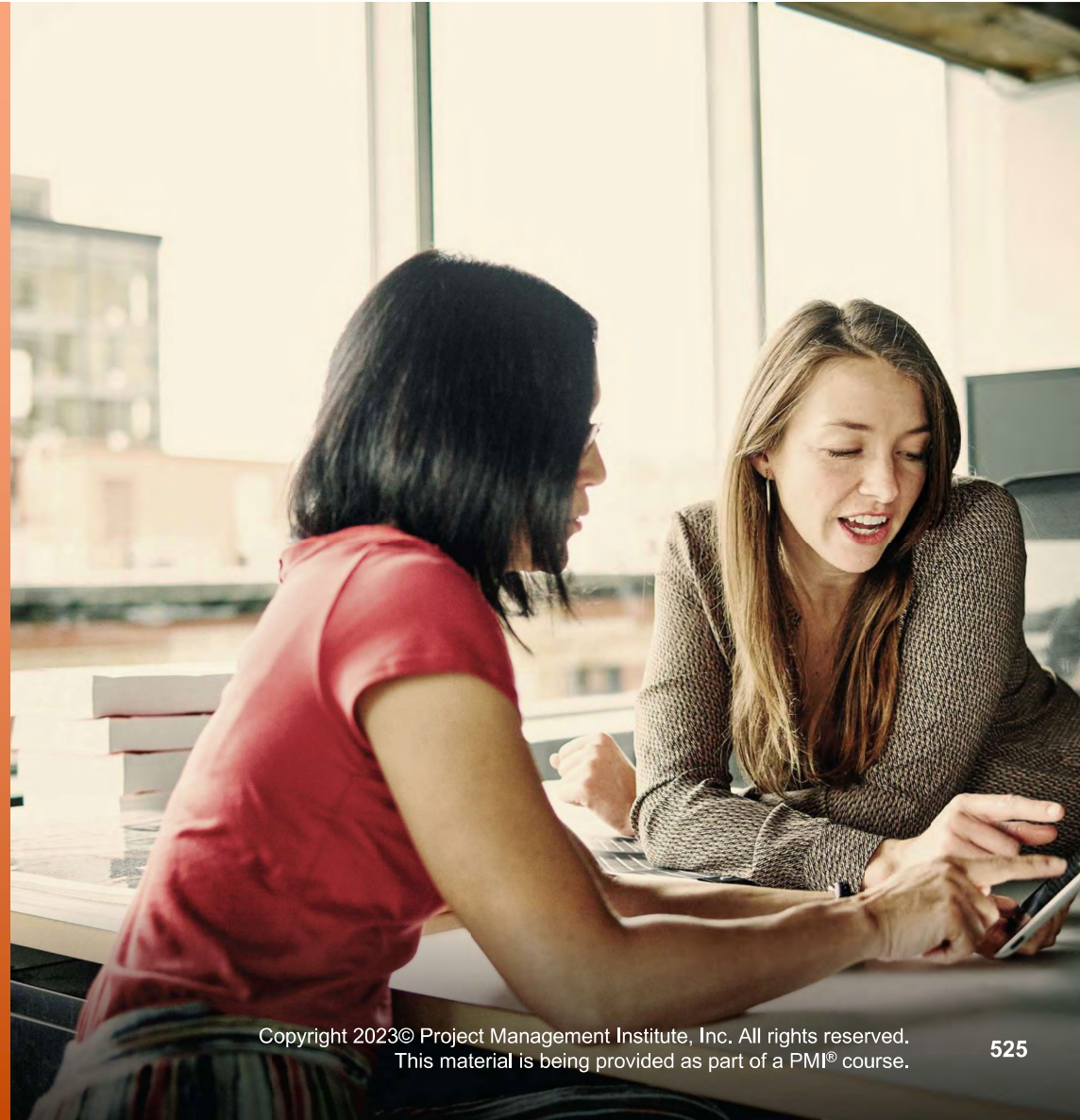

Plan for Training, Coaching and Mentoring



-
- Perform a **gap analysis** to identify required knowledge, skills, or attributes.
 - Plan for a suitable **diversity of training and coaching offerings**.
 - Soft skills
 - Technical skills
 - Part of team-building or fun/informal activity
 - **Schedule training** close to the time of solution implementation
 - Consider **upskilling or certification** for team members
 - Encourage valued stakeholders to become mentors

Know the Value of Training, Coaching and Mentoring

Treat knowledge as an asset!

- Conduct a **cost-benefit analysis** to determine the potential value in cost savings — e.g., replacing outsourced labor
- Help others or yourself to **improve skills and knowledge**
- Increase the team's ability to **increase quality, output, and value**
- **Build relationships and trust** with stakeholders and team members

Training, Coaching and Mentoring Discussion



Have you ever had a valuable trainer, coach or mentor?

- *Describe why they were effective.*

Would people think YOU are a valuable trainer, coach or mentor? Why?



Elements of Training

- Provided to teams, small groups or individuals
- Covers management, technical or administrative topics
- Delivery models:
 - Instructor-led classroom
 - Virtual classroom
 - Self-paced eLearning
 - Document reviews
 - Interactive simulations
 - On-the-job training



Coach Teams and Individuals in Project Management



Acknowledge informal opportunities that may already be happening:

- Delegate tasks, observe and provide feedback
- Encourage others to take the lead on activities
- Collaborate on a project management task

Introduce formal opportunities:

- Facilitate meetings and sessions
- Transfer skills by pairing individuals
- Model behaviors

Self-Organizing Teams Collaborate and Learn

- Encourage **self-organization** and **initiative** in daily work life
- Coach individuals on **how to contribute** to other project roles
- Coach an individual with **tacit knowledge**
- Use **servant leadership**
- Use **job shadowing, coaching** or **mentoring** during transitions to transfer knowledge and skills from project team to organization

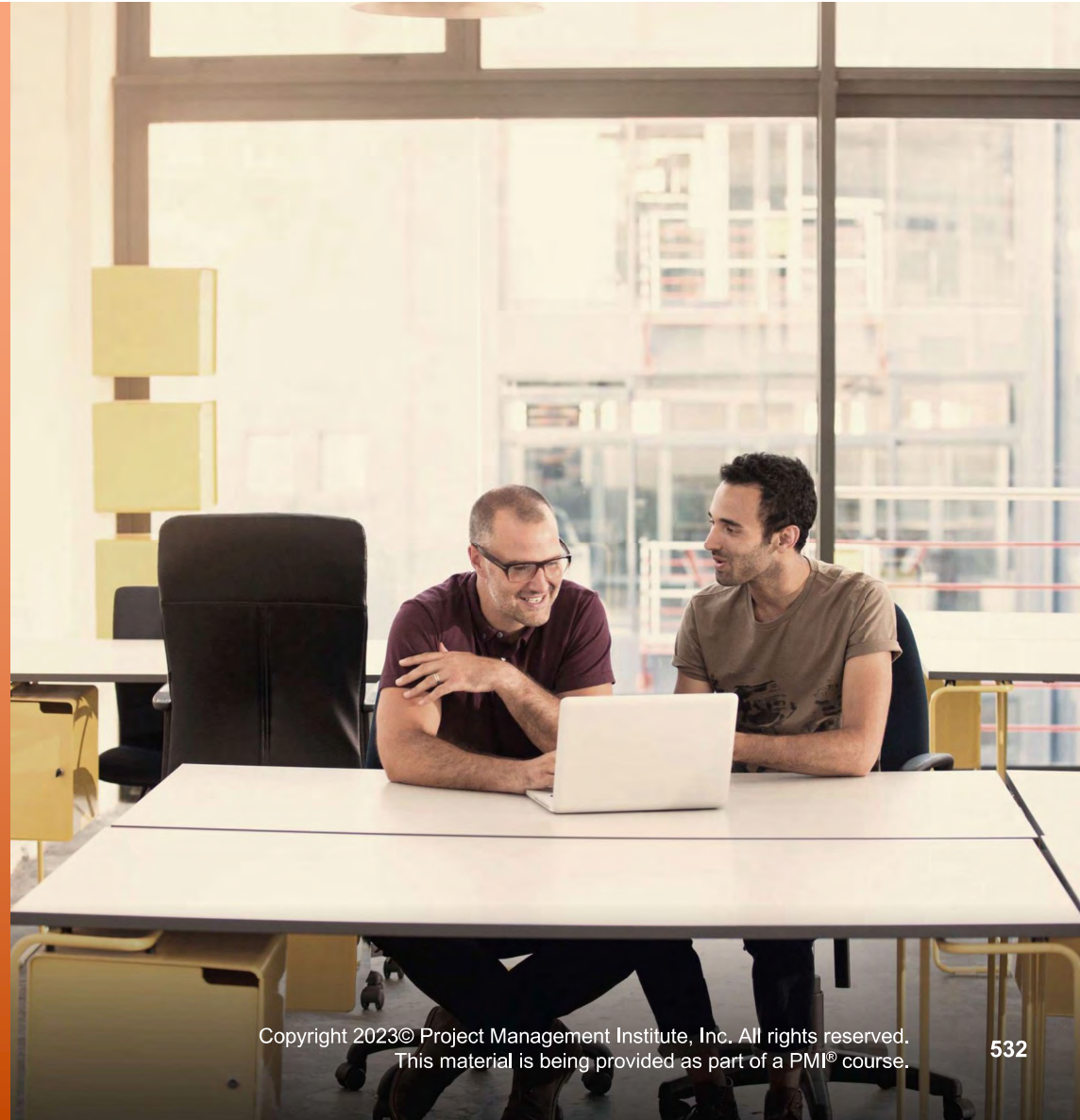

Teams Learn

and **initiative** in

contribute to

knowledge

ing or mentoring

knowledge and
anization

TACIT KNOWLEDGE

Personal knowledge that can be difficult to articulate and share such as beliefs, experience, and insights.

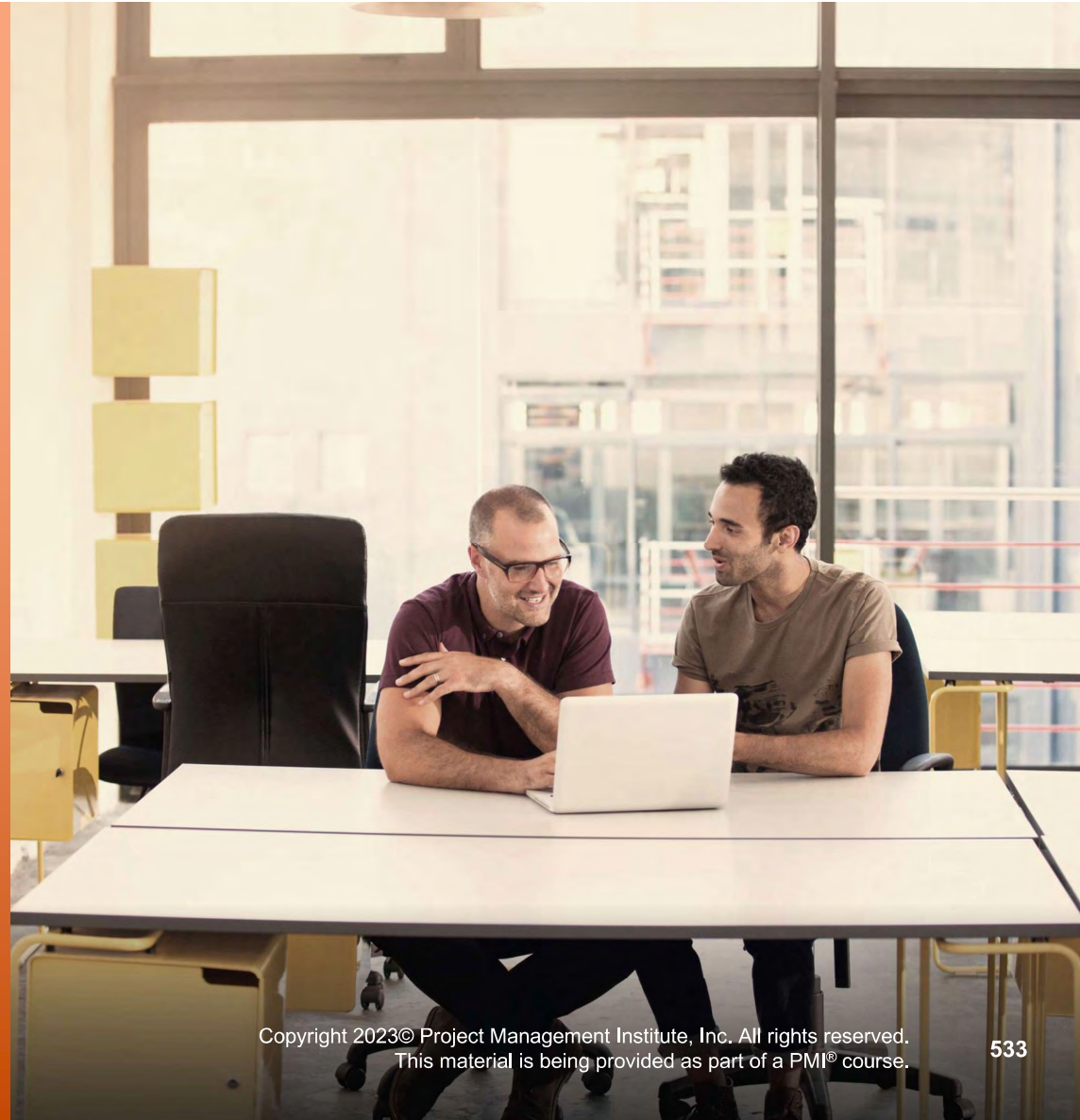

Measure Training Outcomes

Measurement of training includes noting improvements with:

- Post-training performance assessments
- Observation of knowledge or skill improvement
- Certifications – badges, letter from awarding body
- Discuss and share training outcomes in team retrospectives

Augment training through coaching to **convert learning into active use of knowledge**. Try pairing team members in knowledge-sharing relationships.



If desired outcomes are not achieved, record this in the lessons learned and try to find out why.

Maintain Mentorships

- Longer-term partnerships that enable professional growth
- Job-shadowing engagements enable transfer of explicit and tacit knowledge
- Tailor to context and desired engagement — e.g., some organizations use mentorships to train project managers and may use reporting to guide development, while others use an informal approach



ECO Coverage

1.6 Build a team

- Appraise stakeholder skills (1.6.1)

1.5 Ensure team members/stakeholders are adequately trained

- Determine required competencies and elements of training (1.5.1)
- Determine training options on training needs (1.5.2)
- Allocate resources for training (1.5.3)
- Measure training outcomes (1.5.4)

1.13 Mentor relevant stakeholders

- Allocate the time for coaching mentoring (stakeholders) (1.13.1)
- Recognize and act on coaching mentoring opportunities (1.13.2)

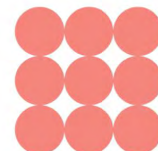
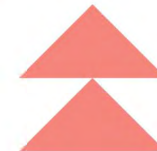
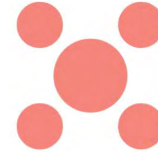
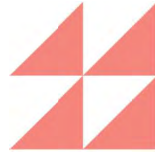



Manage Conflict

TOPIC G

Why Conflict Management Matters



Ineffective conflict management leads to:

- Destructive behavior
- Animosity
- Poor performance
- Reduced productivity

Effective conflict management leads to:

- Improved understanding
- Better performance
- Higher productivity

Conflict Management

Roles

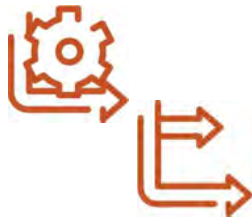

All team members and stakeholders are responsible for managing conflict
Project managers **influence the direction and handling of conflict** through **interpersonal skills** and **servant leadership**



The team is empowered to resolve conflicts; the team lead can facilitate resolution.

Causes of Conflict

Context

- Competition
- Differences in objectives, values, and perceptions — this can be ideological
- Disagreements about role requirements, work activities and individual approaches
- Communication breakdowns
- Projects are unique and team members not worked together before



Copyright 2023© Project Management Institute, Inc. All rights reserved.
This material is being provided as part of a PMI® course.

Conflict as Part of Team Culture

In a **psychologically safe** work environment:

- View disruption and innovation as connected
- Encourage exchanges and disagreement
- Prevent escalation to conflict



Copyright 2023© Project Management Institute, Inc. All rights reserved.
This material is being provided as part of a PMI® course.

How to Handle Conflict



Use preferred ways of managing conflict from the **team charter** and **ground rules**. Provide guidance and resources to help the team.



Agile teams include conflict management strategies in their way of working (WoW) and are supported by a culture of trust.



Focus on the issues and not on individuals.

Dealing with Difficult People



Dealing with Difficult People

Spotlight Series

This presentation focuses a spotlight on Dealing with Difficult People!

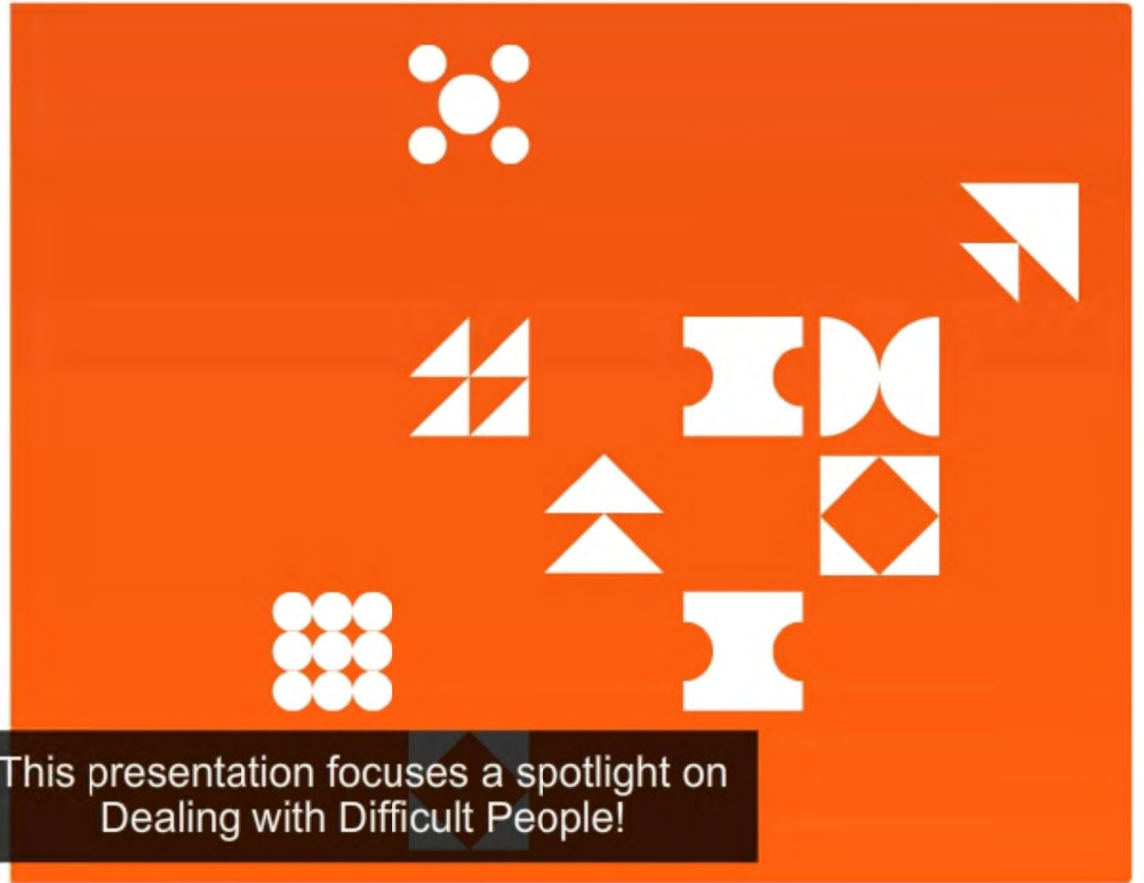

Use Leas' Levels of Conflict

Conflict intensifies from level 1 to 5

From task-orientated with possible resolution to a personal or relationship orientation, where **the focus on issues is lost.**

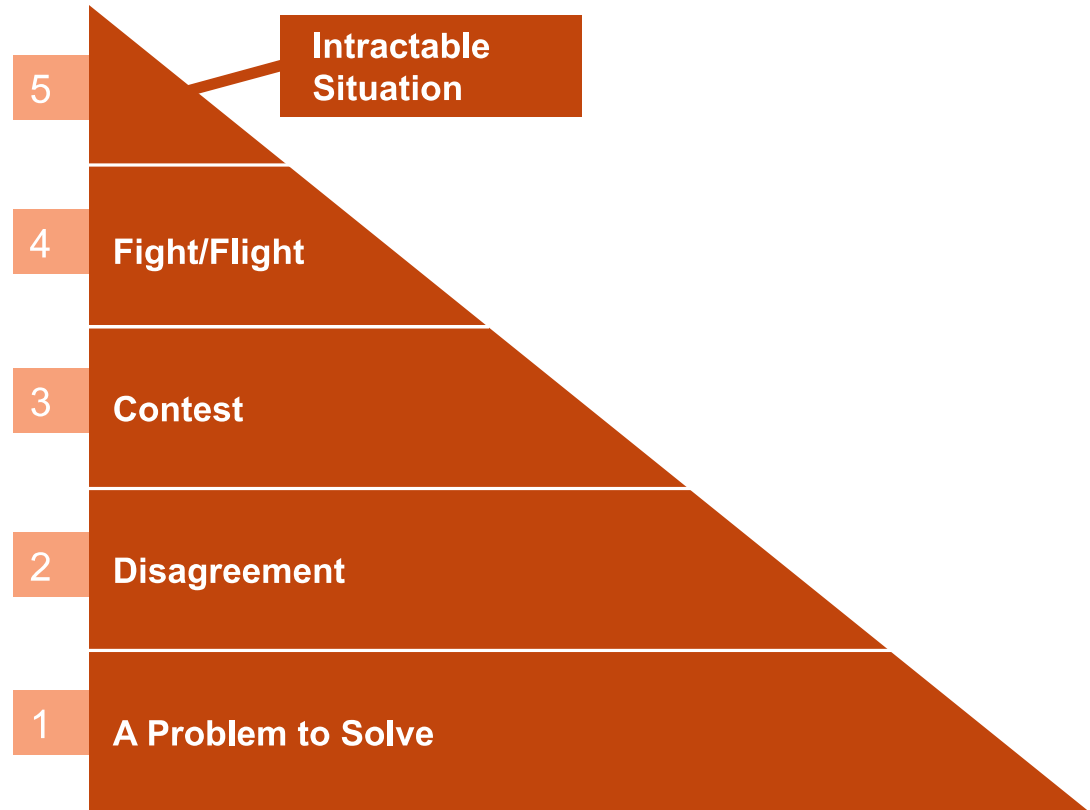

Conflict Model by Speed B. Leas (2012)

Use Interpersonal Skills to Manage Conflict

Emotional Intelligence

Use empathy to understand and diffuse situations

Influencing

Persuade parties to reconsider or change their tone, approach, or mindset

Leadership

Steer others in a more positive direction

Decision-Making

Offer a solution to move the situation forward

Active Listening

Listen for personalized, accusing language and bitter or caustic tone, defensive or aggressive physical postures

Conflict Management Approaches

Smooth/ Accommodate	<ul style="list-style-type: none">• Emphasize areas of agreement• Concede position to maintain harmony and relationships
Withdraw/ Avoid	<ul style="list-style-type: none">• Retreat from the situation• Postpone the issue
Compromise/ Reconcile	<ul style="list-style-type: none">• Both parties give something up to reach an agreement• Sometimes known as a “lose/lose” scenario
Force/Direct	<ul style="list-style-type: none">• Pursue your viewpoint at the expense of others• Offer only win/lose solutions
Collaborate/ Problem Solve	<ul style="list-style-type: none">• Incorporate several viewpoints and insights from varying perspectives• Requires cooperative attitude and open dialogue• Search for solutions that typically lead to consensus and commitment



Root cause analysis – **5 Whys Method**

ECO Coverage

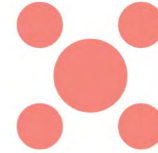

1.1 Manage conflict

- Interpret the source and stage of the conflict (1.1.1)
- Analyze the context for the conflict (1.1.2)
- Evaluate/recommend/reconcile the appropriate conflict resolution solution (1.1.3)

1.12 Define team ground rules

- Discuss and rectify ground rule violations (1.12.3)

1.10 Build shared understanding

- Investigate potential misunderstandings (1.10.4)
- Break down situations to identify the root cause of a misunderstanding (1.10.1)

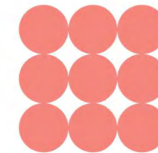
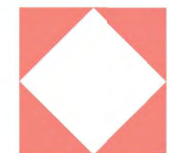
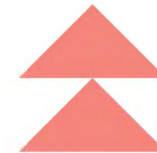

LESSON 5

SUPPORT PROJECT TEAM PERFORMANCE

- Implement Ongoing Improvements
- Support Performance
- Evaluate Project Progress
- Manage Issues and Impediments
- Manage Changes

Version 3.2 | 2023 Release



Learning Objectives

- Explain the various methods for implementing improvement.
- Explain the various methods for performance measurement.
- Compare these methods with a focus on communication and accountability.
- Identify the methods for implementing a project and the issues and impediments that arise during a project.
- Describe the methods for implementing changes during a project.

Project Life Cycle Check-In

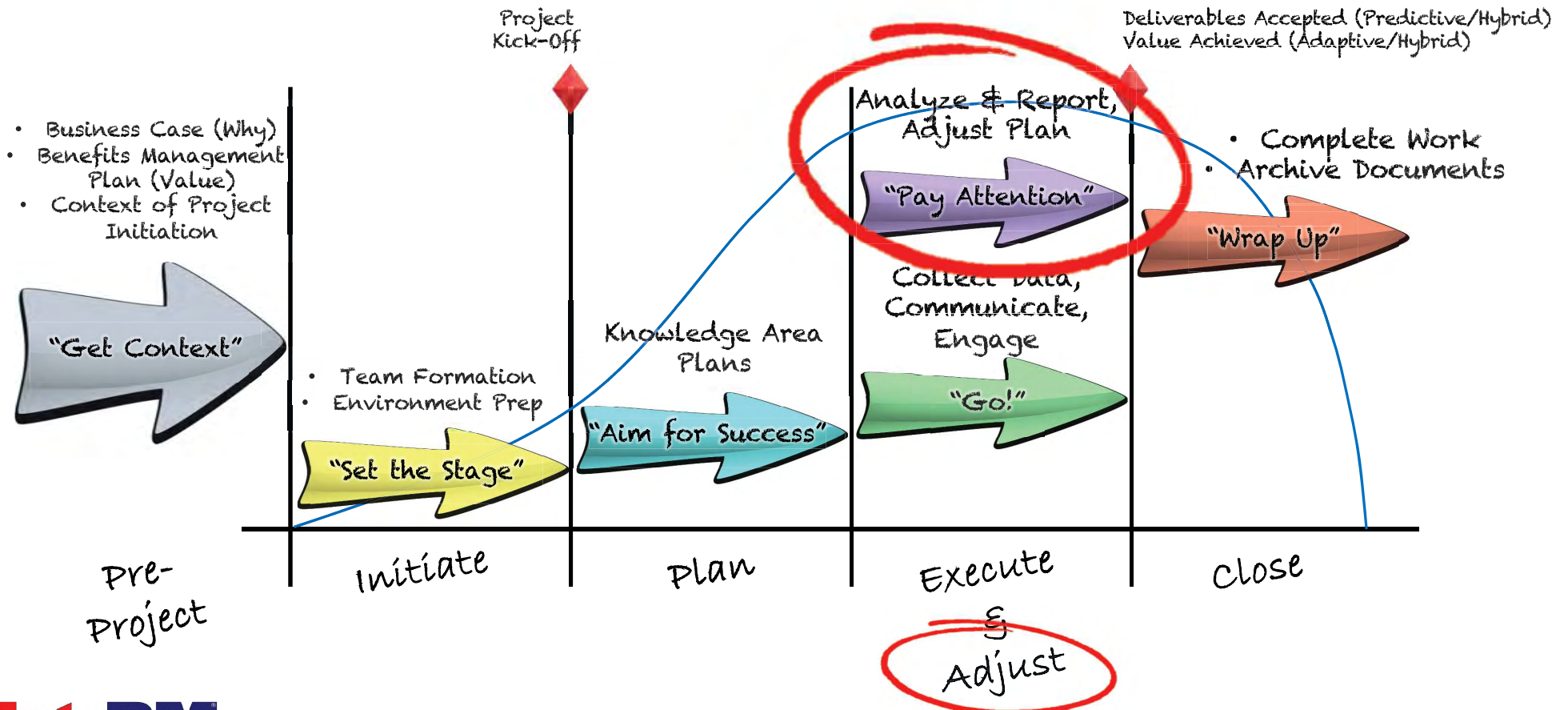



Implement Ongoing Improvements

TOPIC A

Continuous Improvement (CI)

- An ongoing effort to improve products, services or processes through small, incremental improvements or large breakthroughs
- A business strategy developed at the organizational level for projects to adopt and use
- Typically implemented by an organization's PMO and/or a "structured learning" approach or CI framework such as Agile or Six Sigma

KAI ZEN
改 善
KAI = Change ZEN = Good

Kaizen



Assess Current CI Methods

How well are the team and organization equipped for CI?

-
- Is the **lessons learned register** up to date? Is the team having regular **retrospectives**? Are team members **Lean Six Sigma** or certified in an **agile** method?
 - Do they know about **Kaizen, Lean, Crystal Methods** or **Capability Maturity Model Integration (CMMI)**?
 - Also check the **process improvement plan** and the **project management plan!**



Use the risk register to assess current CI measures. It includes how the team is prepared to act to address threats to project quality, so it can be a helpful way of assessing current CI measures.



LEAN SIX SIGMA

A collaborative team method that provides an enhanced ability to target customer needs and measure performance during project execution and monitoring. It was introduced by American engineer Bill Smith while working at Motorola in 1986.

-
- Is the **lessons learned register** up to date? Is the team having regular **retrospectives**? Are team members **Lean Six Sigma** or certified in an **agile** method?
 - Do they know about **Kaizen, Lean, Crystal Methods** or **Capability Maturity Model Integration (CMMI)**?
 - Also check the **process improvement plan** and the **project management plan!**



Use the risk register to assess current CI measures. It includes how the team is prepared to act to address threats to project quality, so it can be a helpful way of assessing current CI measures.

Conduct Retrospectives

Review and Improve Methods



- Prepare topics for inspiration
- On a board, make two columns →
- Ask attendees to add items to these lists
- Allow each participant to identify the reason for the improvement
- Decide common items that need improvement and mark them
- Narrow the list to improvement areas that will bring value in the next sprint
- Get team consensus on the plan improvement
- Update these tasks on the backlog after a discussion with the product owner
- Implement changes

Went Well	Need to Improve
<ul style="list-style-type: none">• On-time completion	<ul style="list-style-type: none">• Retrospective method• Keep workspace tidy

Improve Your Improvement Methods



In addition to using the **lessons learned register** and **retrospectives** properly, try:

Experiments

- Use **A/B testing** and team **feedback** to identify improvements
- **Experiments** provide a way to improve team efficiency and effectiveness
- Apply controls — do them one at a time — to isolate the results

Pareto chart, or the 80/20 rule

- Directs efforts where they can make the biggest impact
- Takes a big problem and breaks it down into smaller pieces



A/B TESTING

A marketing approach used to determine user preferences by showing different sets of users' similar services—an 'Alpha' and a 'Beta' version—with one independent variable.

PARETO CHART

A histogram that is used to rank causes of problems in a hierarchical format. See also "80/20 Rule".

80/20 RULE

A general guideline with many applications; in terms of controlling processes, it contends that a relatively large number of problems or defects, typically 80%, are commonly due to a relatively small number of causes, typically 20%. See also "Pareto Chart".



g the **lessons learned register** and **retrospectives**

y and team **feedback** to identify improvements
provide a way to improve team efficiency and

— do them one at a time — to isolate the results

ne **80/20 rule**

where they can make the biggest impact

blem and breaks it down into smaller pieces

Update Processes and Standards



Use what you learned from successful experimentation to fashion and recommend CI steps

Can lessons learned at the project level apply to the organization's continuous improvement process?

If so, escalate these lessons as an opportunity for adoption at the organizational level

Interactive/Discussion



What are improvement procedures in your organization?

What methods do you use?



Lead With an Improvement Mindset

- Educate yourself
- Encourage a “fail fast” mindset
- Identify material improvements, training, processes or equipment
- Measure the effect of any change
- Then repeat!



Topics Covered

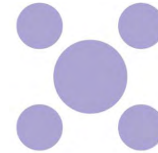

Continuous Improvement

- Plan continuous improvement methods, procedures and tools
- Assess CI framework
- Plan CI methods, procedures, tools
- Recommend/Execute CI steps

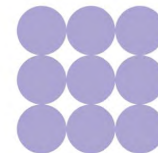

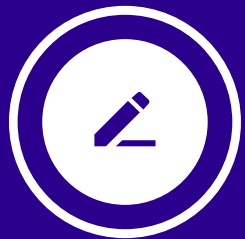

Support Performance

TOPIC B

Project Team Leadership Objectives



Communicate (and re-communicate) the project's objectives

Ensure fluid knowledge-sharing, a continued healthy dynamic on the team, welcome new team members, realign the team.

Focus the team on delivering value

Manage with Objectives, Tolerances, Thresholds

Use clear and effective communication with clear **objectives** throughout the life cycle for a more productive and driven team.

Know the **thresholds** and **tolerance** levels that enable you to effectively manage a variation without needing to escalate.

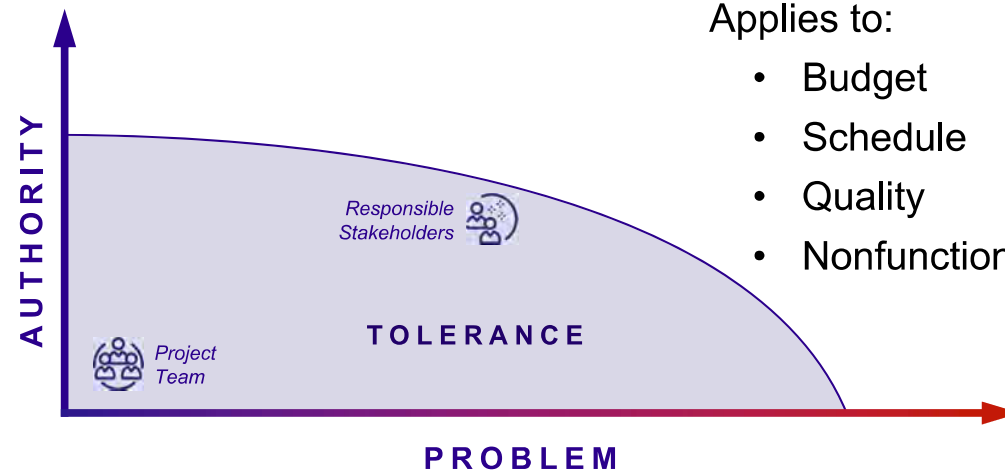

Applies to:

- Budget
- Schedule
- Quality
- Nonfunctional requirements

The Project Manager's Role

Centralized Model



ANG FEN
PROJECT
MANAGER



- Ensures alignment of due dates — project deliverables, project life cycle and benefits realization plan
- Provides a project management plan
- Ensures creation and use of appropriate knowledge to/from the project
- Manages project performance and changes to project activities
- Makes integrated decisions about key changes that impact the project
- Measures and monitors progress, and takes appropriate action
- Collects, analyzes and communicates project information to relevant stakeholders
- Ensures completion of all project work and formally closes each phase, contract and the project as a whole
- Manages phase transitions when necessary



These tasks cannot be delegated.

Team Roles and Responsibilities to Support Performance Review Exercise



ANG FEN

PROJECT
MANAGER

In this hybrid project, the _____ oversees project management plan integration, but delegates control of detailed product planning and delivery to the _____.



TEAM

The _____ focuses on building a cross-functional team, a collaborative decision-making environment and ensuring the team can respond to changes.



GREER

SCRUM
MASTER /
AGILE COACH

The process role of _____ helps the team to understand the agile mindset and use scrum processes. To develop the SLC product, the _____ is the local domain expert that plans how to do the work and the _____ looks after value creation.



HELEN

PRODUCT
OWNER

Team Roles and Responsibilities to Support Performance Review Exercise



ANG FEN

PROJECT
MANAGER

In this hybrid project, the project manager oversees project management plan integration, but delegates control of detailed product planning and delivery to the product owner.



TEAM

The project manager focuses on building a cross-functional team, a collaborative decision-making environment and ensuring the team can respond to changes.



GREER

SCRUM
MASTER /
AGILE COACH

The process role of scrum master/agile coach helps the team to understand the agile mindset and use scrum processes. To develop the SLC product, the team is the local domain expert that plans how to do the work and the product owner looks after value creation.



HELEN

PRODUCT
OWNER

Optimize Communication

-
- Use **retrospectives** purposefully — discuss how to improve ways of working
 - Communicate in both group and face-to-face settings — especially important for remote or virtual teams
 - Make communication positive and regular with **internal** and **external** team members and stakeholders
 - Use technology and tools; get **feedback** about them and tailor for optimization



Where did the team record expectations about communication?

Optimize Communication

-
- Use **retrospectives** purposefully — discuss how to improve ways of working
 - Communicate in both group and face-to-face settings — especially important for remote or virtual teams
 - Make communication positive and regular with **internal** and **external** team members and stakeholders
 - Use technology and tools; get **feedback** about them and tailor for optimization



*Where did the team record expectations about communication?
In the **team charter!***

Use Feedback to Support High Performance

- Feedback is crucial for any team, using any method, in any environment
- Communicate in detail about technical and “soft” performance aspects
- Use appropriate methods — e.g., public or private, individual or group, written or verbal
- Give feedback in a timely manner
- Request feedback regularly, as and when needed

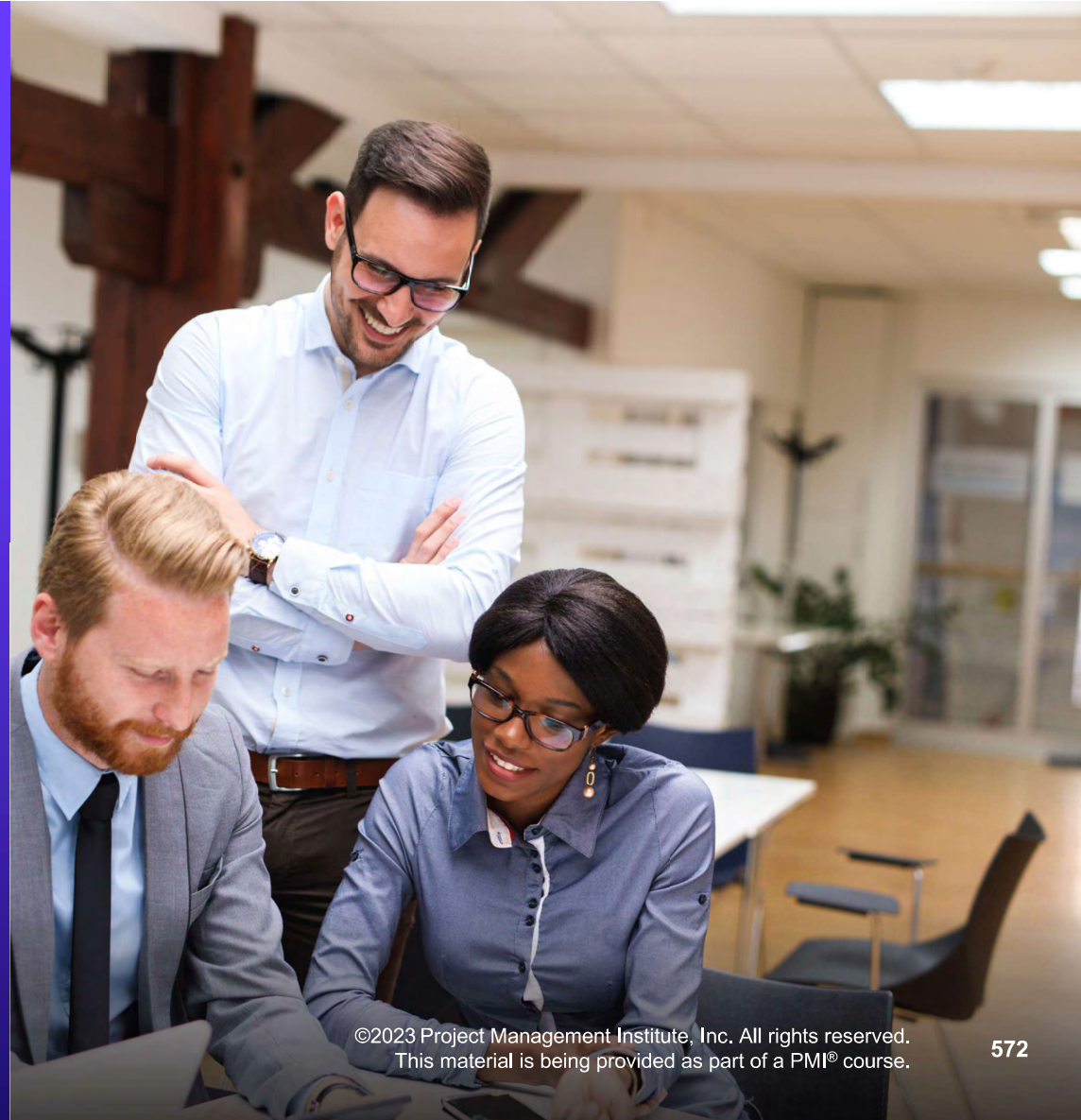

©2023 Project Management Institute, Inc. All rights reserved.
This material is being provided as part of a PMI® course.

Support Team Task Accountability

Encourage team members to self-organize in determining:

- What work needs to be done
- How to perform the work
- Who should perform it

Use kanban boards to promote visibility and collaboration.

Agile teams commit to performing work listed on a backlog during an iteration.

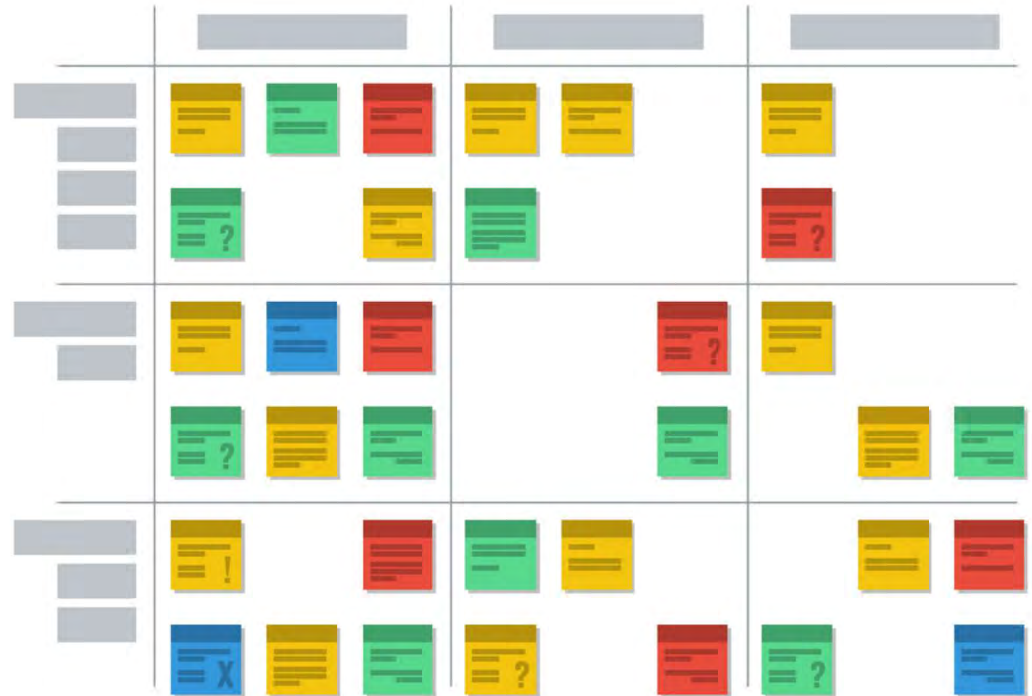

Show Roles and Responsibilities

RAM/RACI



Some accountabilities are set and nontransferable, even on agile teams. Can anyone give an example?



Responsibility assignment matrix (RAM):

- Describes participation by various project roles in completing work or deliverables
- Clarifies roles and responsibilities

Uses **RACI** nomenclature:

- **Responsible:** Does the work
- **Accountable:** Approves completion
- **Consulted:** Gives expert opinion
- **Informed:** Kept up to date



Project manager creates RAM/RACI.



Project manager or team lead works with team to make decisions about roles and responsibilities.

Curate Knowledge as an Asset

Document **explicit knowledge** for archival and sharing.

Encourage individuals to share **tacit knowledge** and collaborate.

Treat knowledge as an asset to the team and organization.



e as an

EXPLICIT KNOWLEDGE

Knowledge that can be codified using symbols such as words, numbers, and pictures. This type of knowledge can be easily documented and shared with others.

ge for archival

are **tacit**

t to the team

TACIT KNOWLEDGE

Personal knowledge that can be difficult to articulate and share such as beliefs, experience, and insights.



Incorporate Knowledge Transfer Opportunities

- Networking
- Special interest groups — e.g., **Communities of Practice**
- Meetings, seminars or other in-person and virtual events
- Training
- **Work/job shadowing**



COMMUNITY OF PRACTICE (COP)

As described by E. Wenger in his book, *Cultivating Communities of Practice*, the CoP uses the same basic idea as used by Shell in their off-shore drilling platforms to establish local forums of “experts” with the specific mandate to create an arena in which project managers would feel comfortable sharing their findings and learnings from their projects.

WORK SHADOWING

An on-the-job technique that enables someone to learn about and perform a job while observing and working with another, more experienced person.

unities

and

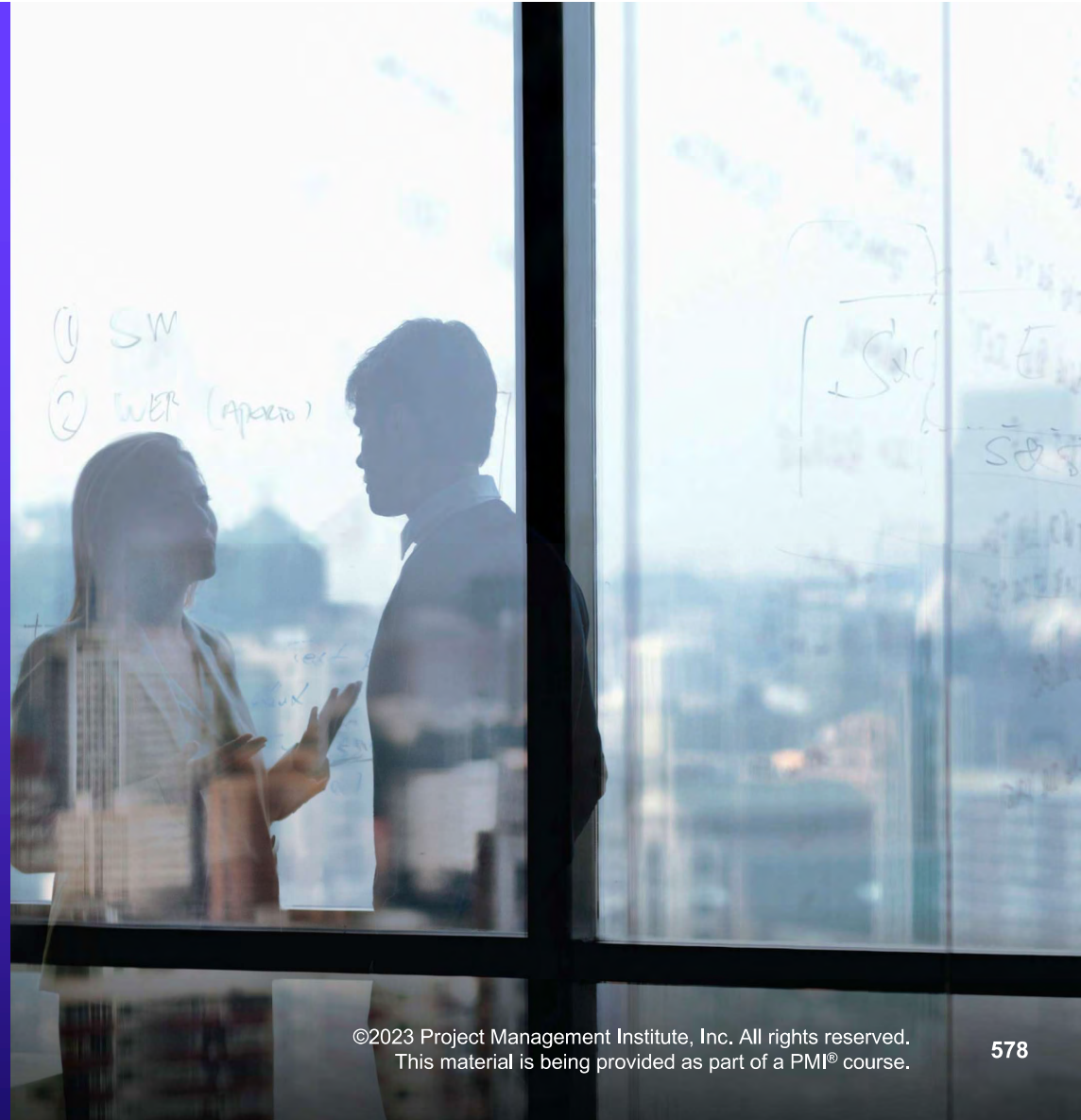

Knowledge Management

Three Levels

Individual

What do team members need to know to perform project work?

Acquire required knowledge through research and collaboration with other team members

Project

What's required to achieve project goals?

Transfer knowledge from other projects and consult the project management office (PMO)

Organization

What's required to manage programs or portfolios?

Adapt knowledge from other programs/portfolios and tailor

Learn the Right Way to Motivate Your Team



DO

- Inspire and motivate yourself and the team – provide opportunities, not obligations
- Give virtual teams constant and regular contact
- Provide appropriate training opportunities
- Try self-assessment and reflective moments for professional growth

DON'T

- Overwhelm with meetings and work interruptions
- Distract with non-project work
- Force group activities

Continuously Realign Team Efforts with Value Delivery



Tuckman's ladder

Prioritize team cohesion and focus on value delivery

As team members or external parties join or depart, or during change or disruption, support the team as it realigns itself

- Welcome each new member as a potential **source of new knowledge** and **motivation**
- Ensure **shared understanding** of project goals and agreements
- Collaborate to find out how they can **add value**
- Navigate disruptions and conflict constructively

Check on Artifact Maintenance

- Make it part of regular quality checks
- Keep file storage organized and versioned
- Ensure compliance with data protection and security mandates
- Maintain artifacts in preparation for archiving during project closure

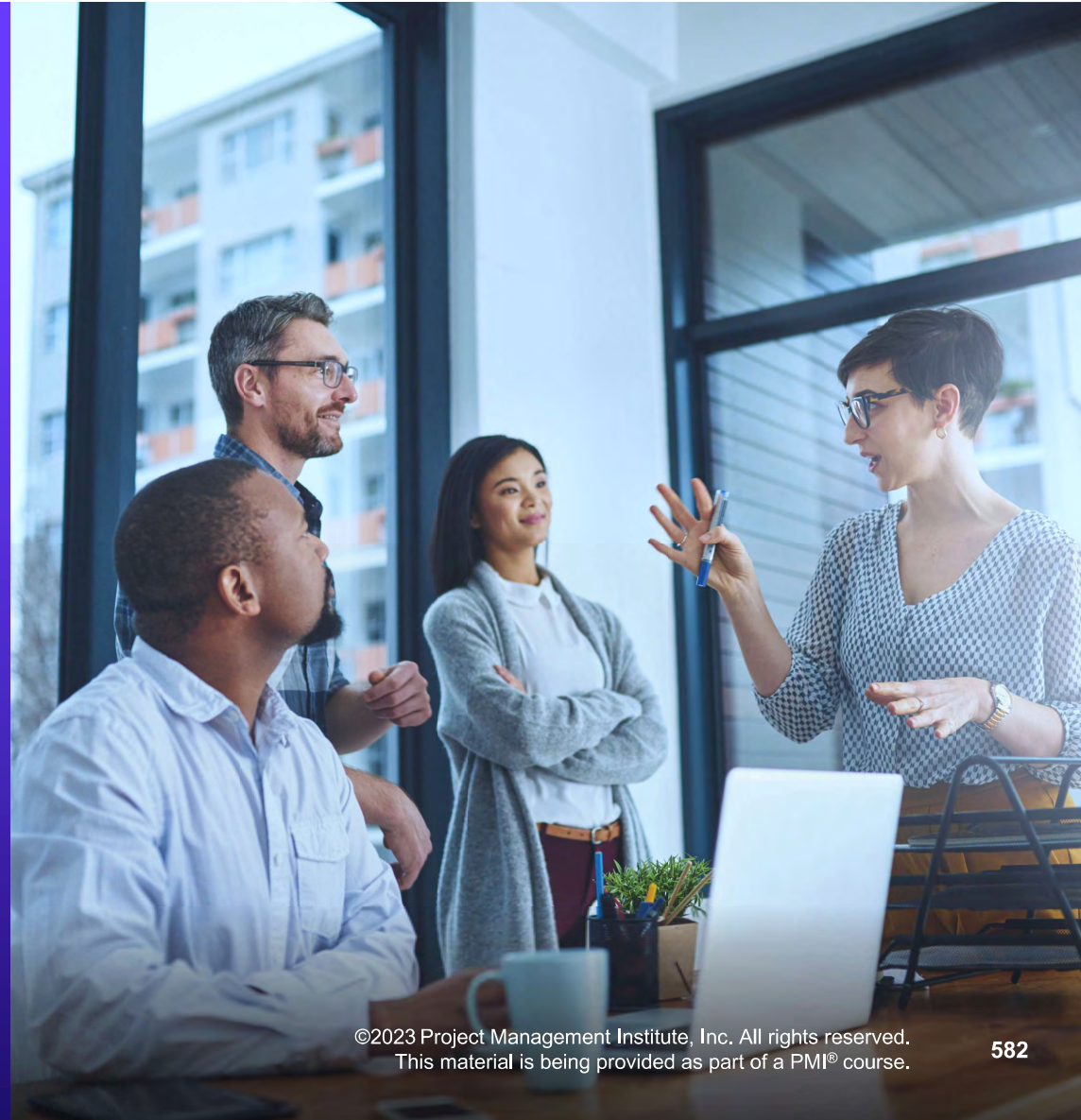

ECO Coverage

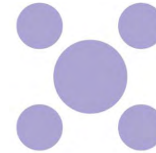

2.2 Manage communications

- Communicate project information and updates effectively (2.2.3)
- Confirm communication is understood and feedback is received (2.2.4)

1.4 Empower team members and stakeholders

- Support team task accountability (1.4.2)
- Evaluate demonstration of task accountability (1.4.3)

1.6 Build a team

- Continuously assess and refresh team skills to meet project needs (1.6.3)
- Maintain team and knowledge transfer (1.6.4)

1.11 Engage and support virtual teams

- Continually evaluate effectiveness of virtual team member engagement (1.11.4)

2.11 Manage project artifacts

- Continually assess the effectiveness of the management of the project artifacts (2.12.3)

2.13 Determine appropriate project methodology/methods and practices

- Use iterative, incremental practices throughout the project life cycle (e.g., lessons learned, key stakeholder engagement, risk) (2.13.4)

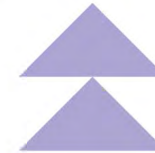



Evaluate Project Progress

TOPIC C

Guidelines to Measuring Performance

“Only Measure What Matters”

- John Doerr



Tailor performance measurement to the project context and stakeholders:

- **Scope**
 - Percentage of work completed
 - Change requests
- **Schedule**
 - Actual duration of work against projected start and finish dates
- **Budget**
 - Actual costs
 - Check procurements are sufficient for needs
- **Resources**
 - Team allocations/availability/procurement
 - Performance appraisals – team, including vendors
 - Contract management
- **Quality**
 - Technical performance
 - Defects
- **Risk**
 - Risk register

Project Status Reports



Project Status Reports

Spotlight Series

In this presentation, the spotlight is shining on Project Status Reports!



Report on Performance

Tailor If Required



Milestone schedule	High-level visualization of progress on work against planned dates
Quality reports	Charts and reports based on the quality metrics collected
Earned value management (EVM) reports	Graphs and values based on EVM equations
Variance analysis reports	Graphs and their analysis comparing actual results to expected results.
Work performance reports	Physical or electronic representation of work performance information compiled in project documents, intended to generate decisions, actions, or awareness.
Dashboards	Physical or electronic progress summaries, usually with visuals or graphics to represent the larger data set

Monitor Scope

	Description of Scope	Method
	<p>Scope baseline is:</p> <ul style="list-style-type: none"> • Approved version of the project scope statement • Work breakdown structure (WBS) • Associated WBS dictionary 	<p>Measure completion of project scope against the scope baseline.</p>
	<p>Scope evolves from:</p> <ul style="list-style-type: none"> • Initial product roadmap to • Release backlog to • Iteration backlogs <p>Backlogs (including product features and functions and user stories) reflect identified, updated and reprioritized product needs</p>	<p>Check user stories and DoD against customer feedback and product requirements</p>
	<p>Any combination of the above</p>	

Scope Validation

Customer Accepts Completed Deliverables



Acceptance criteria



- Definition of ready (DoR)
- Definition of done (DoD)
- Acceptance criteria
- Iteration reviews



Any combination of the above



In a predictive development approach, which artifact helps determine the acceptance criteria?

- a. Responsibility traceability matrix
- b. Scope statement
- c. Team charter
- d. Stakeholder engagement plan



In an adaptive development approach, what helps determine that the acceptance criteria for user stories has been met?

- a. Product roadmap
- b. Definition of done
- c. Release plan
- d. Kanban board

Scope Validation

Customer Accepts Completed Deliverables



Acceptance criteria



- Definition of ready (DoR)
- Definition of done (DoD)
- Acceptance criteria
- Iteration reviews



Any combination of the above



In a predictive development approach, which artifact helps determine the acceptance criteria?

- a. Responsibility traceability matrix
- b. Scope statement**
- c. Team charter
- d. Stakeholder engagement plan



In an adaptive development approach, what helps determine that the acceptance criteria for user stories has been met?

- a. Product roadmap
- b. Definition of done**
- c. Release plan
- d. Kanban board

Measure Schedule Performance

Methods

Gantt charts: Schedule performance tracking over time

Earned value: Cost and effort performance tracking against planned value (PV)

Quality metrics: Track quality deliverables, defects and acceptable output

Variance analysis: Shows where the project is against where it should be

- Compare work delivered and accepted to estimations for the current iteration/sprint
- Review completed work in regular sprint demos
- Determine production, validation, and acceptance rates for deliverables in **retrospectives**
- Conduct scheduled reviews to record retrospective discoveries



EARNED VALUE (EV)

A measure of work performed expressed in terms of the budget authorized for that work.

QUALITY METRIC

A description of a project or product attribute and how to measure it.

VARIANCE ANALYSIS

A technique for determining the cause and degree of difference between the baseline and the actual performance.

Schedule Performance

Schedule performance tracking over time

Earned value: Cost and effort performance tracking against planned value (PV)

Quality metrics: Track quality deliverables, defects and acceptable output

Variance analysis: Shows where the project is against where it should be

Work delivered and accepted to estimations for the current iteration/sprint

Completed work in regular sprint demos

Production, validation, and acceptance rates for deliverables in

Reviews

Scheduled reviews to record retrospective discoveries

Schedule Management Tools

- Adjust schedule to reflect resource supply/demand
- Use smoothing and leveling
- Use schedule compression techniques, including fast tracking and crashing

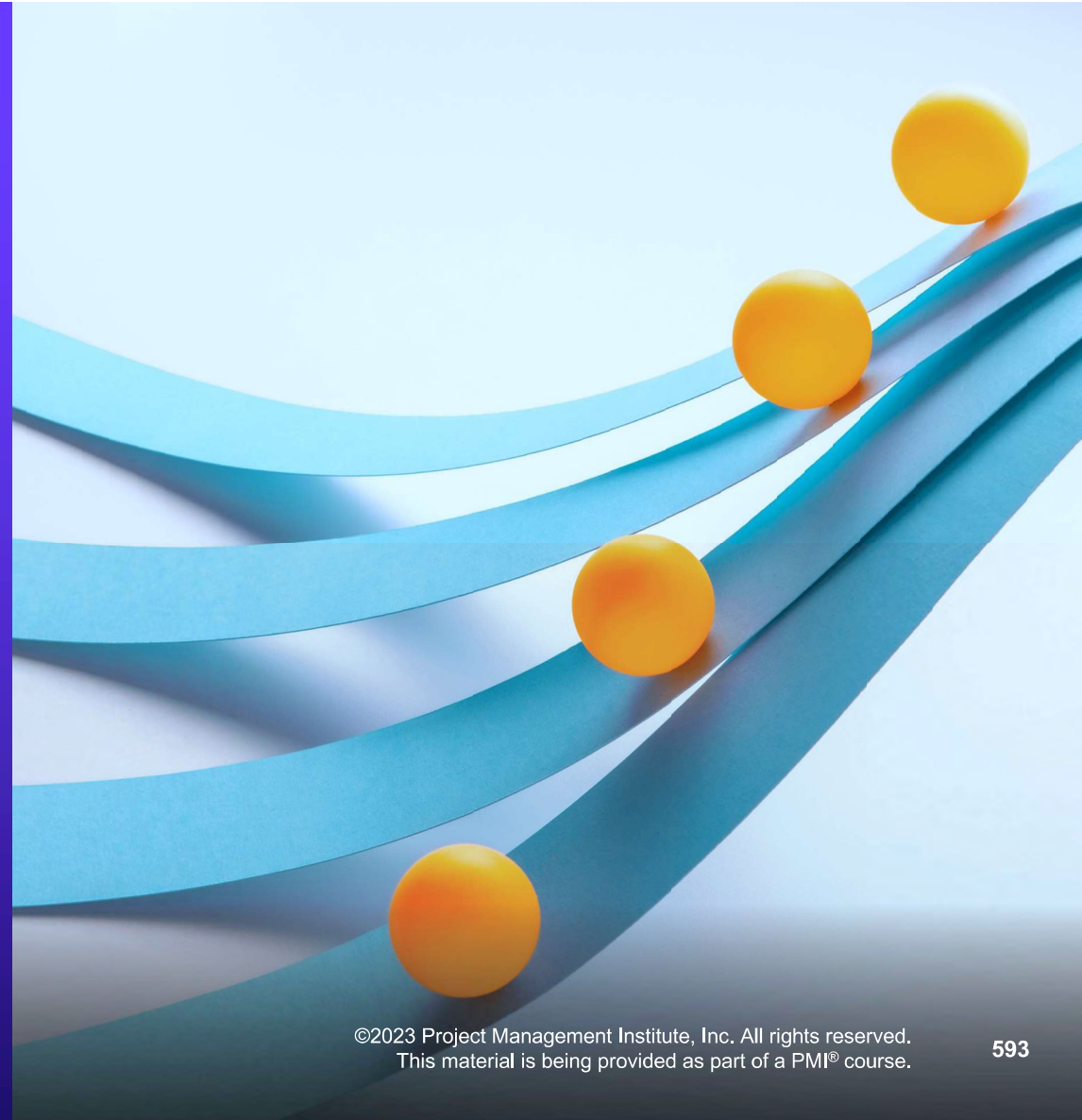

Visualize Performance

Show committed versus completed work



-
- Display visuals or graphics on team dashboards (electronic or physical)
 - Show product backlog progress on **burndown** and **burnup** charts
 - Display project data and progress on graphic **information radiators** in prominent places
 - Measure performance with lead and cycle times with a **cumulative flow diagram**

 - Agile approaches may use **kanban** or **task boards** to visualize project work
 - Continuous flow approaches include **throughput**, **cycle time** and **lead time**
 - Timeboxed approaches include **velocity**

Information Radiators



Burn Charts

Burndown (Iteration)



- Tracks the work to be completed in the iteration
- Used to analyze variance to ideal burndown of work committed to during planning



Diagonal line is ideal burndown against which daily actual remaining is charted.

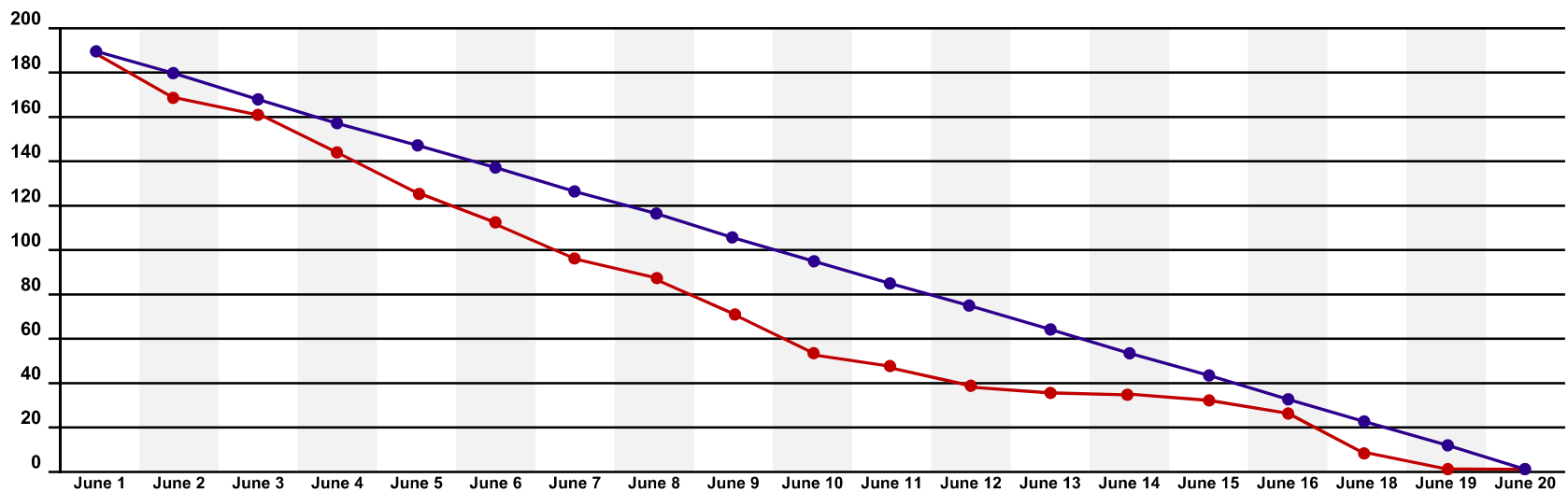

Burn Charts

Burnup (Release)



 aka Feature Complete Graph
in feature-driven development (FDD)

- Show accumulated progress of completed work
- Update after each iteration

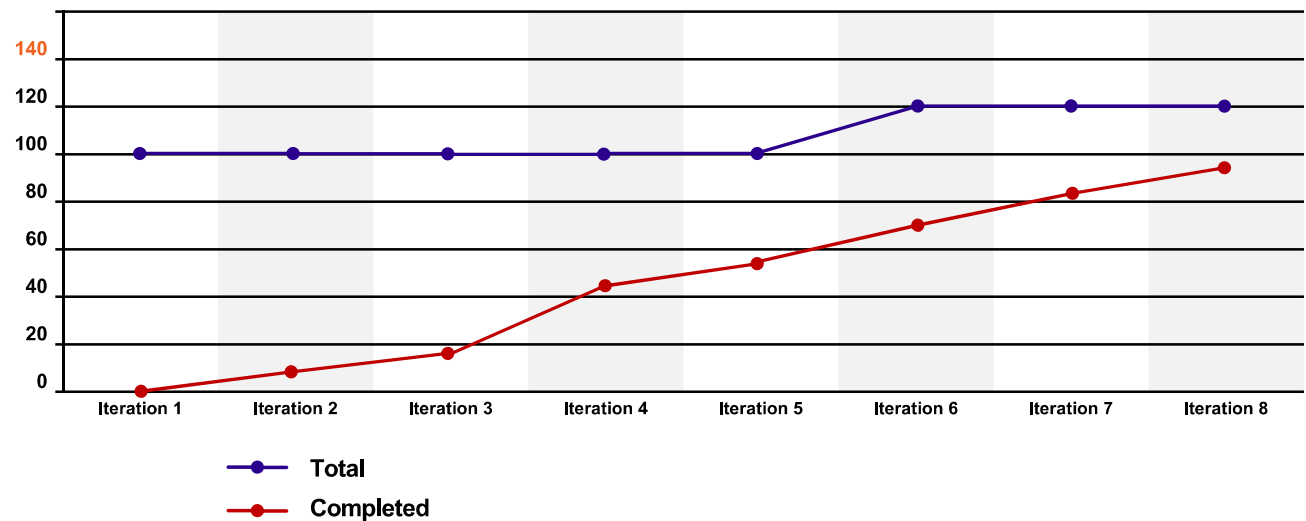

Task Board

- Organize work into tasks on cards
- Display task information at every stage of the workflow
- Tailor your task board workflow stages



Task board types include Kanban, to-do lists, procedure checklists and scrum boards

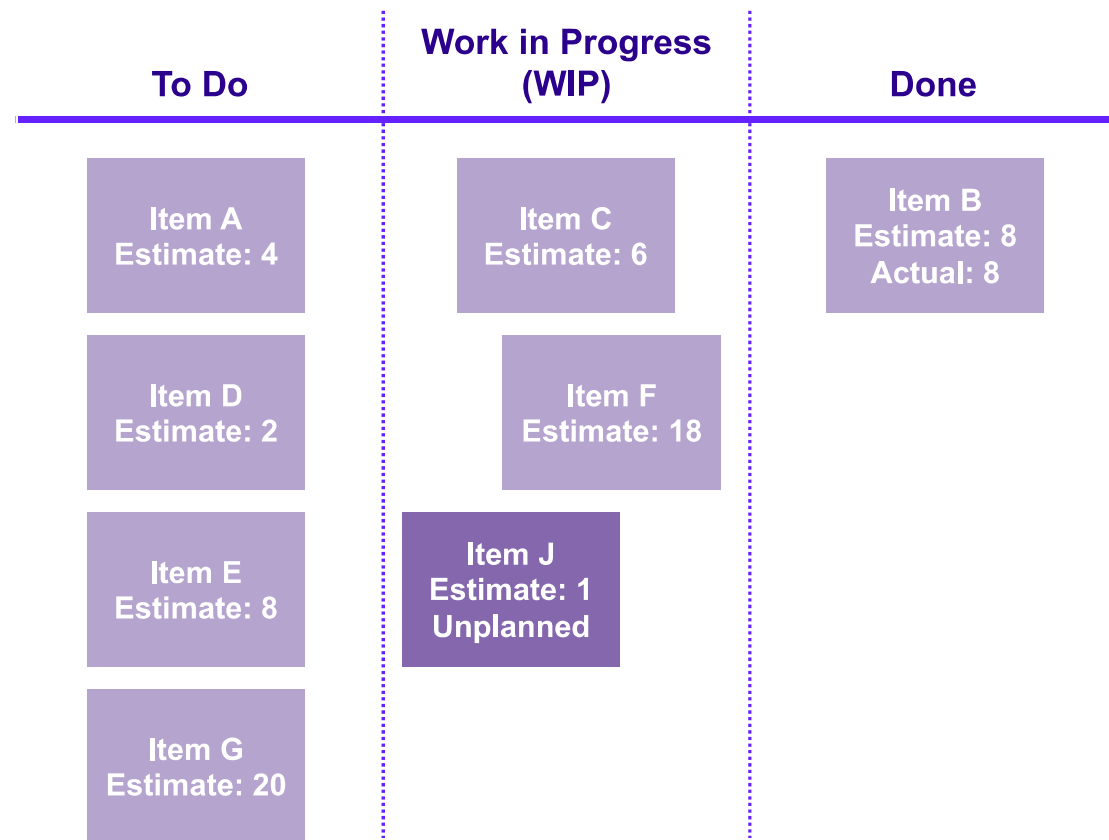

Estimate Velocity

Aim for Constant Rate (with optional discussion)

- Team's estimated rate of progress of completed work
- Calculate by estimating number of story points that can be completed during an iteration
- Then modify during subsequent iterations
- Goal: Achieve constant velocity from one iteration to the next



Velocity is a unique metric to a project; it can't be used to compare the performance of teams.

Velocity Chart

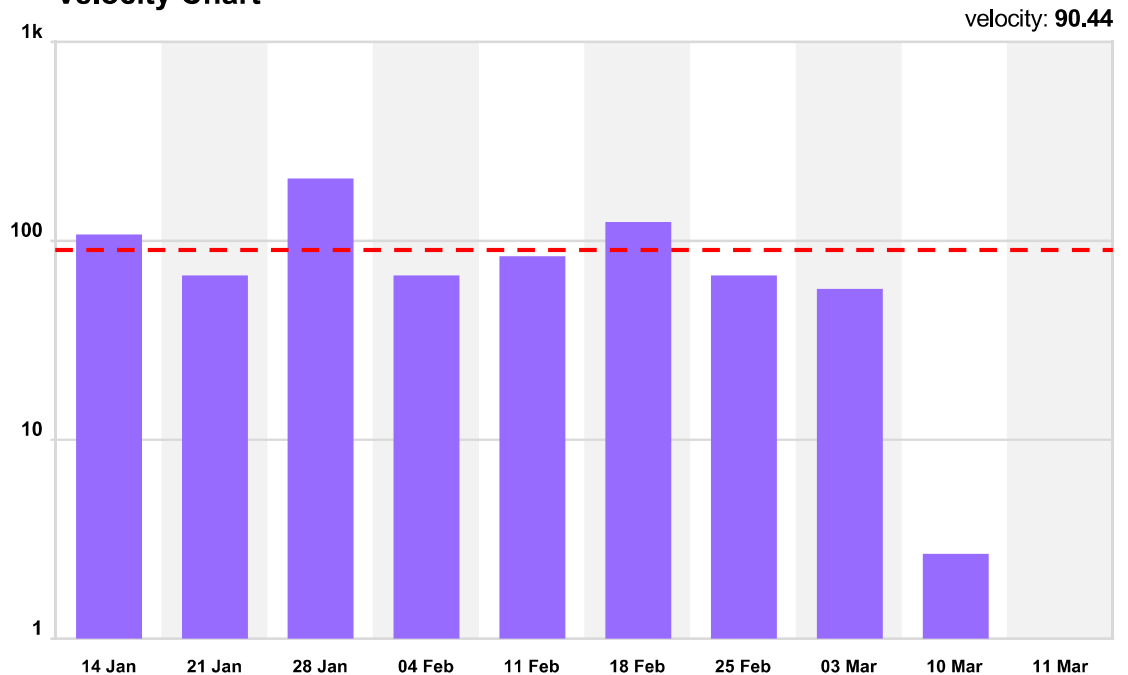

Continuous Flow Approaches

Measure Throughput, Lead and Cycle Time

- **WIP** - Measure of work in progress but not completed
- **Lead time** - Length of time work item goes through entire process
- **Cycle time** - Length of time work item is being worked on
- **Throughput** - Number of items entering or exiting the system

The Cumulative Flow Diagram

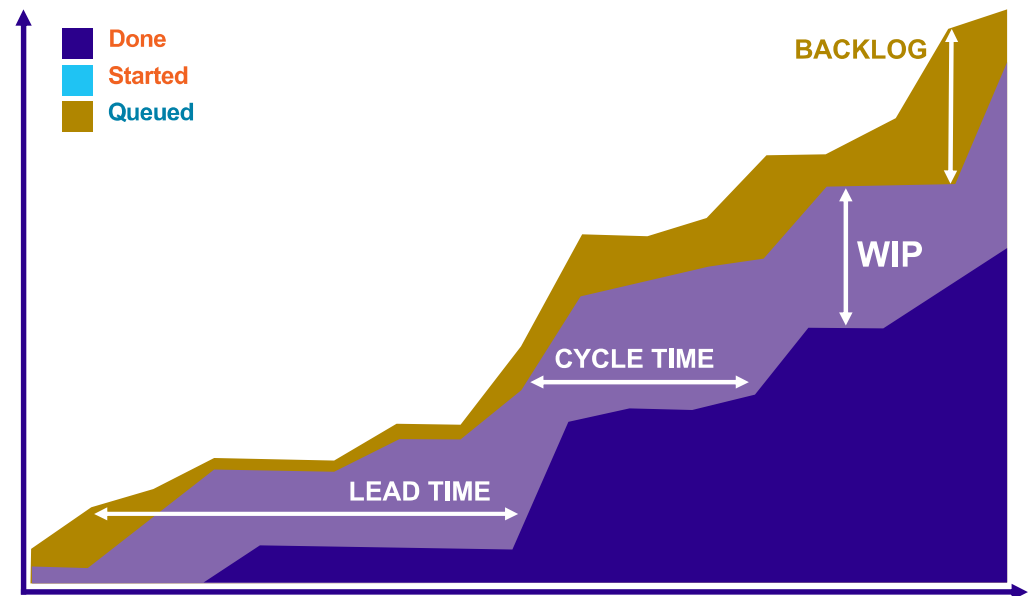

Budget Challenges

- New/changed project requirements
- New risks, or changes to the probabilities or impacts of existing risks
- Changes to cost estimates



Earned Value Management (EVM)



-
- Measure project progress by comparing actual schedule and cost performance against planned performance, per the schedule and cost baselines
 - Evaluate progress of schedule and budget
 - Prevent further degradation of budget or schedule

Earned Value Management (EVM)

Visual

VARIABLES



Planned Value

The authorized budget assigned to scheduled work



Earned Value

The measure of work performed expressed in terms of the budget authorized for that work



Actual Cost

The realized cost incurred for the work performed on an activity during a specific time period

- Planned Value (PV)
- Earned Value (EV)
- Actual Cost (AC)

$$EV = \% \text{ work complete to date} \times \text{budgeted cost}$$

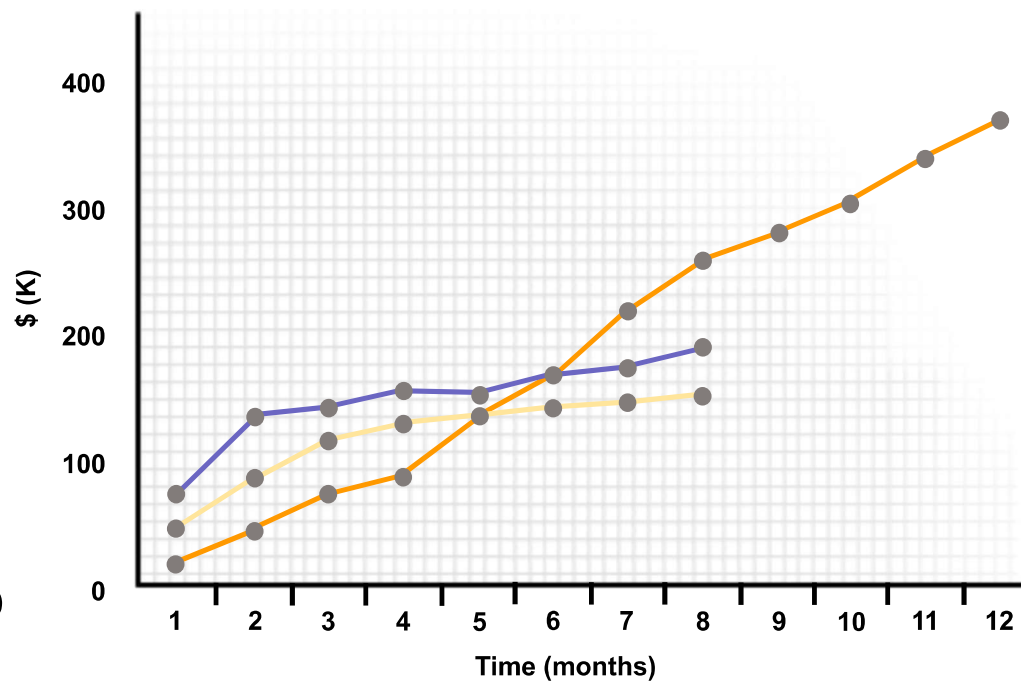

EVM Measures for Schedule Control

Is the project progressing on schedule?

Schedule variance measures performance – by calculating the difference between EV and PV

$$SV = EV - PV$$

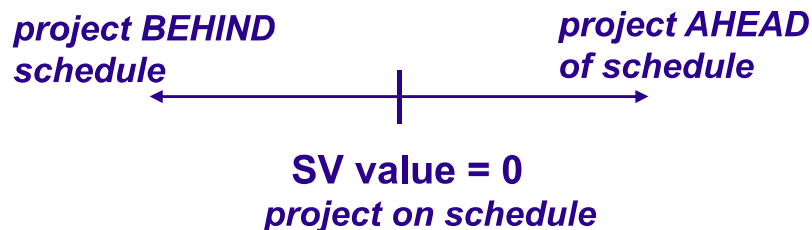

How efficiently is the team working?

Schedule performance index measures efficiency by calculating the ratio of EV to PV

$$SPI = EV / PV$$

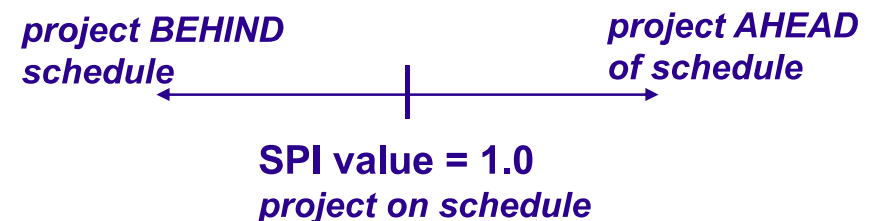

EVM Measures for Cost Control

Is the project on budget?

Calculate **cost variance (CV)** to find the current amount of budget deficit/surplus

$$CV = EV - AC$$

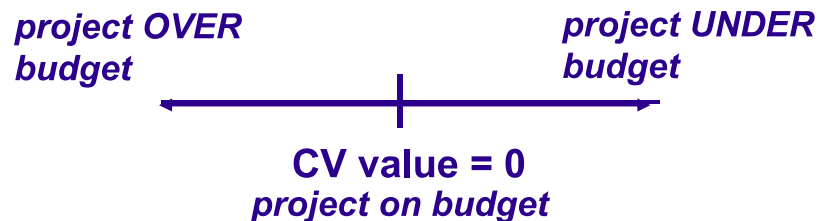

How efficient is my project?

Calculate **cost performance index (CPI)** to measure the cost efficiency of budgeted resources

$$(CPI = EV / AC)$$

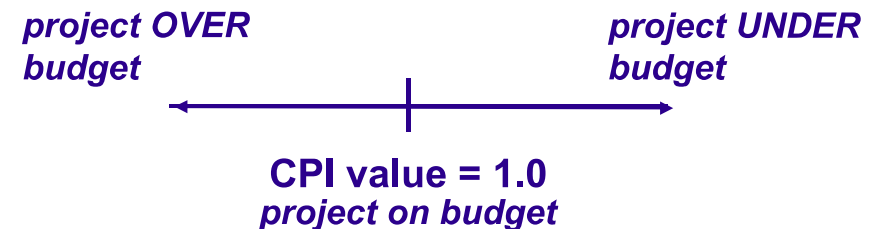

EAC/ETC Analysis



Are more funds required?

What will the project cost in total?

Use **Estimate At Completion (EAC)**

Based on:

- CPI: current spending efficiency
- BAC: budget at completion

Formula

$$EAC = \frac{BAC}{CPI}$$

How much more cost is required to complete the remainder of the project?

Use **Estimate To Complete (ETC)**

Based on:

- CPI
- AC – actual cost

Formula

$$ETC = EAC - AC$$

EVM

Enables comparison of release plan against the actual work done



Helps teams spot any problem areas and ensure they stay on schedule and within budget.

Example Process:

1. Establish a performance measurement baseline (PMB) to create a reference point for the metric
2. Answer three questions:
 - How many iterations are planned?
 - How many story points are there?
 - What is the release budget?
3. Collect data at the end of every iteration:
 - **Planned value (PV):** Budget for planned work in an iteration
 - **Earned value (EV):** Budget for completed work in an iteration
 - **Actual cost (AC):** Actual cost incurred to complete an iteration deliverable

Manage and Lead Resources

- Include team and external contractors
- Monitor for risks — e.g., cost overruns, schedule delays or potential disputes
- Conduct checks on contracts:
 - Procurement process compliance
 - Periodic progress or activity reports
 - Required advance notification and acknowledgment to suppliers
 - Formal acceptance of contracted deliverables
- Notify accounts payable of completed work so that payments can be made

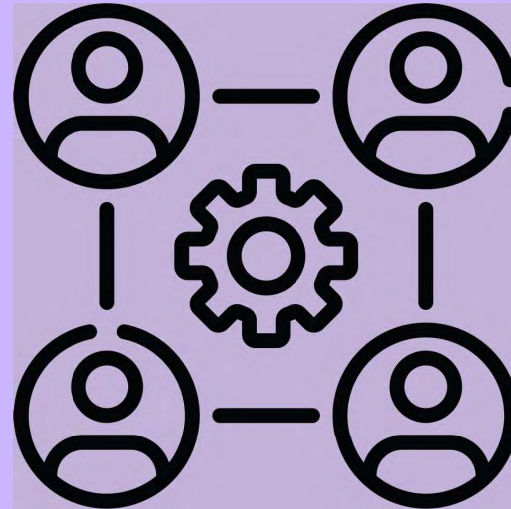

Consult the communications management plan and contract terms and conditions for vendor/supplier working provisions.

Physical Resource Management

-
- Means physical resources (not human)
 - Equipment
 - Materials
 - Facilities
 - Infrastructure
 - Ensures assigned resources are available “just in time” (JIT) and released when no longer needed
 - Ensures physical resources assigned are available as planned
 - Monitors planned vs actual utilization of resources
 - Performs processes throughout the project

Update Resource Allocation



-
- What has been used to date?
 - What is still needed?
 - Review performance usage to date, including:
 - Monitoring expenditures
 - Identifying and dealing with resource shortage/surplus in a timely manner
 - Ensuring resource use and release
 - Informing stakeholders of issues with relevant resources
 - Influencing factors that can create changes in resource utilization
 - Managing changes as they occur
 - Changes that impact schedule or cost baselines must be approved through Perform Integrated Change Control.

Handle Changes and Contract Disputes

When change is required, follow your project's change process:



Perform Integrated Change Control



Backlog reprioritization

For contract disputes, consult OPAs and the contractual agreement first

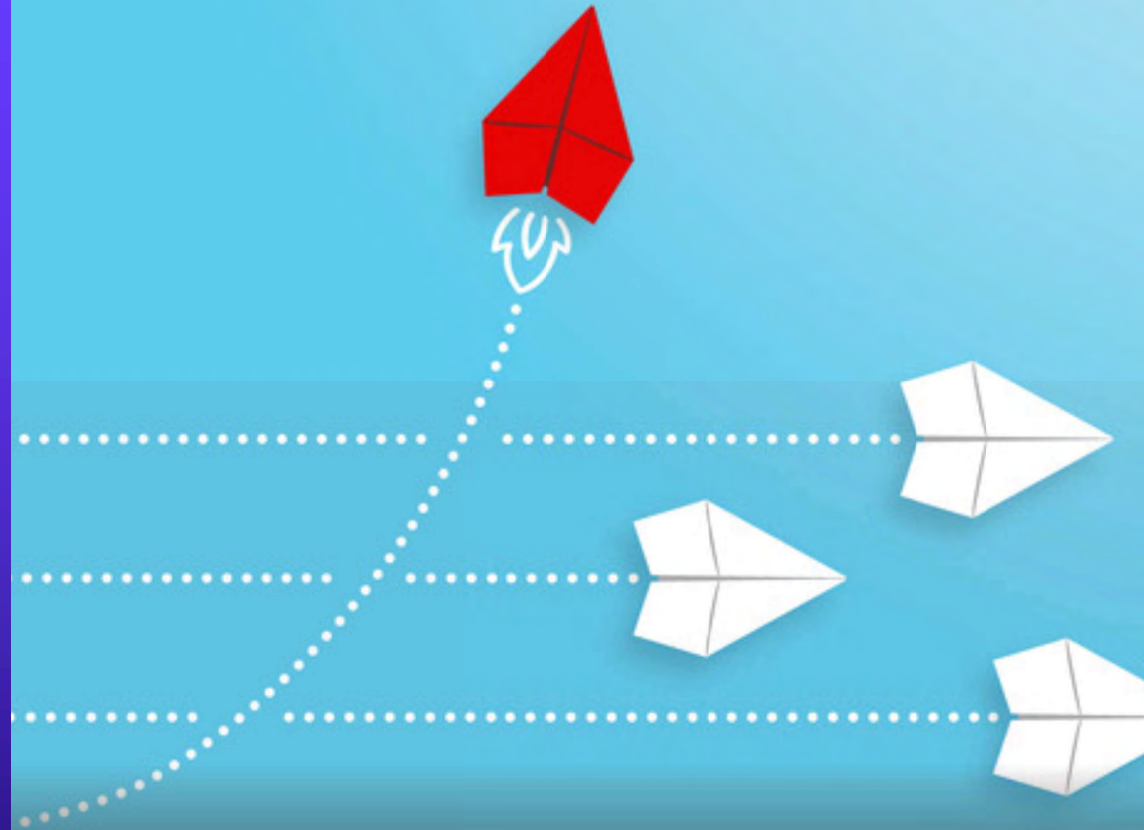

Quality Management Guidelines

- Assess quality of project approaches and activities
- Evaluate deliverable quality through inspection and testing
- Evaluate quality of project activities and processes through reviews and audits
- Focus on detecting and preventing errors and defects

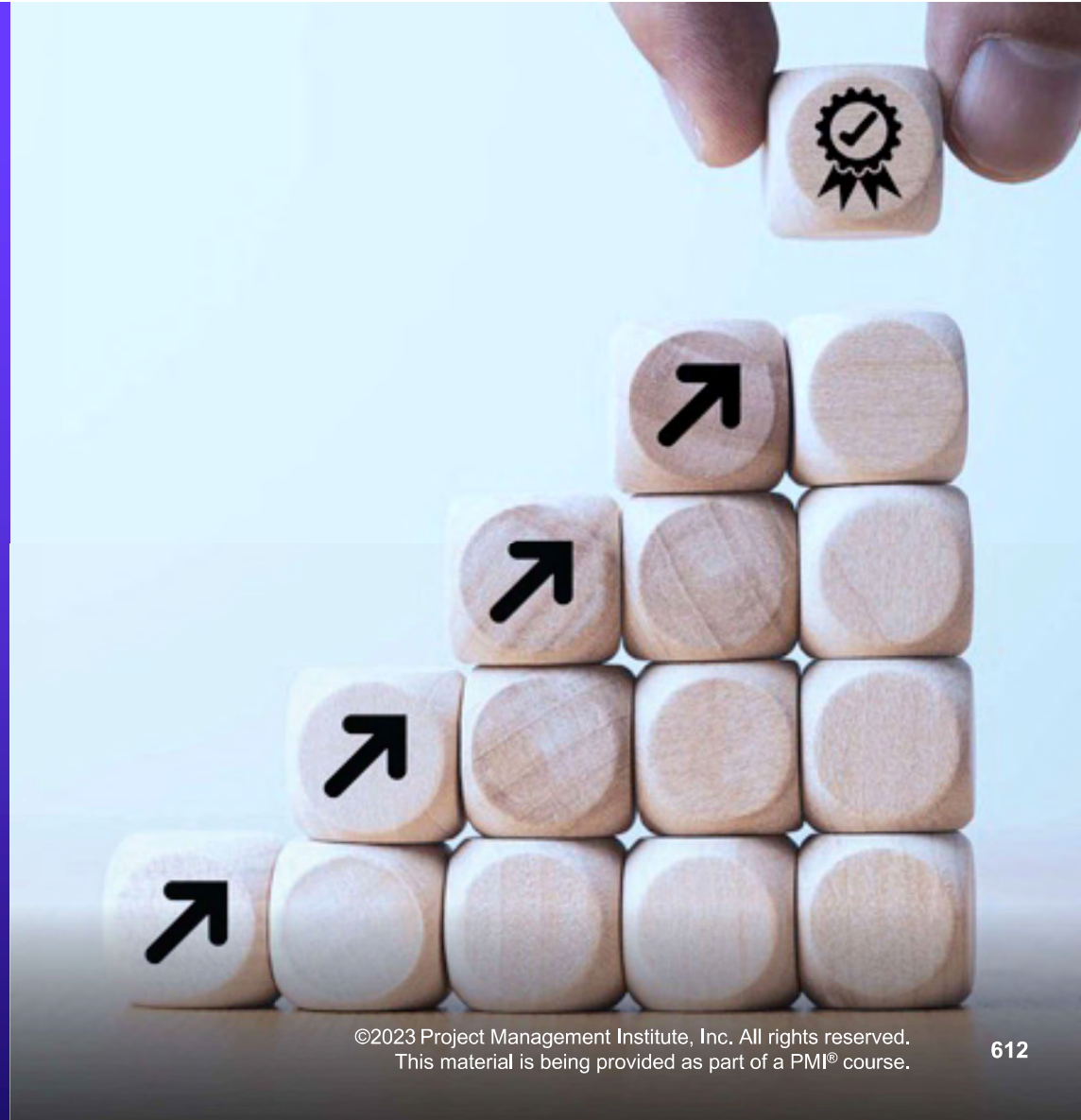

Evaluate and Manage Quality



- Project manager uses Control Quality process to:
 - **Verify** that deliverables meet functional and nonfunctional requirements
 - **Identify** and **suggest improvements**
 - **Verify alignment** with compliance requirements
 - **Give feedback** on any identified variances
 - **Identify potential approaches** to cure defects or other noncompliance
- And continuously monitors quality **reports** and **recommendations!**



- Team, customer and product owner are responsible for setting and meeting quality goals and metrics
- Feedback from iterations continuously monitor quality
- Measure performance of quality with:
 - Service-level agreements (SLAs)
 - KPIs
 - Contractual measures
 - Quality methods/frameworks — e.g., Lean Six Sigma

Quality Audit*

May be scheduled or conducted ad hoc

Topics include:

- Quality management policy
- Collection and use of information
- Analytical methods
- Cost of quality
- Quality process design



Use audits to enhance or formalize the quality management complement in adaptive development approaches.



QUALITY AUDIT

A structured, independent process to determine if project activities comply with organizational and project policies, processes, and procedures.

May be scheduled or conducted ad hoc

Topics include:

- Quality management policy
- Collection and use of information
- Analytical methods
- Cost of quality
- Quality process design



Use audits to enhance or formalize the quality management complement in adaptive development approaches.

Control Quality Tools



Data gathering

- Checklists/check sheets
- Statistical sampling
- Questionnaires and surveys

Data analysis

- Performance reviews
- Root cause analysis

Data representation

- Cause-and-effect diagram
- Scatter diagrams
- Control charts
- Histograms
- Pareto chart



Control Quality Process

Example

1. Use check sheets to collect data
2. Plot data on a histogram
3. Understand the significant ones using the Pareto chart (80/20 rule)
4. Use the cause-and-effect analysis on the chosen problems/solutions
5. Finally, perform a scatter analysis to understand the correlation

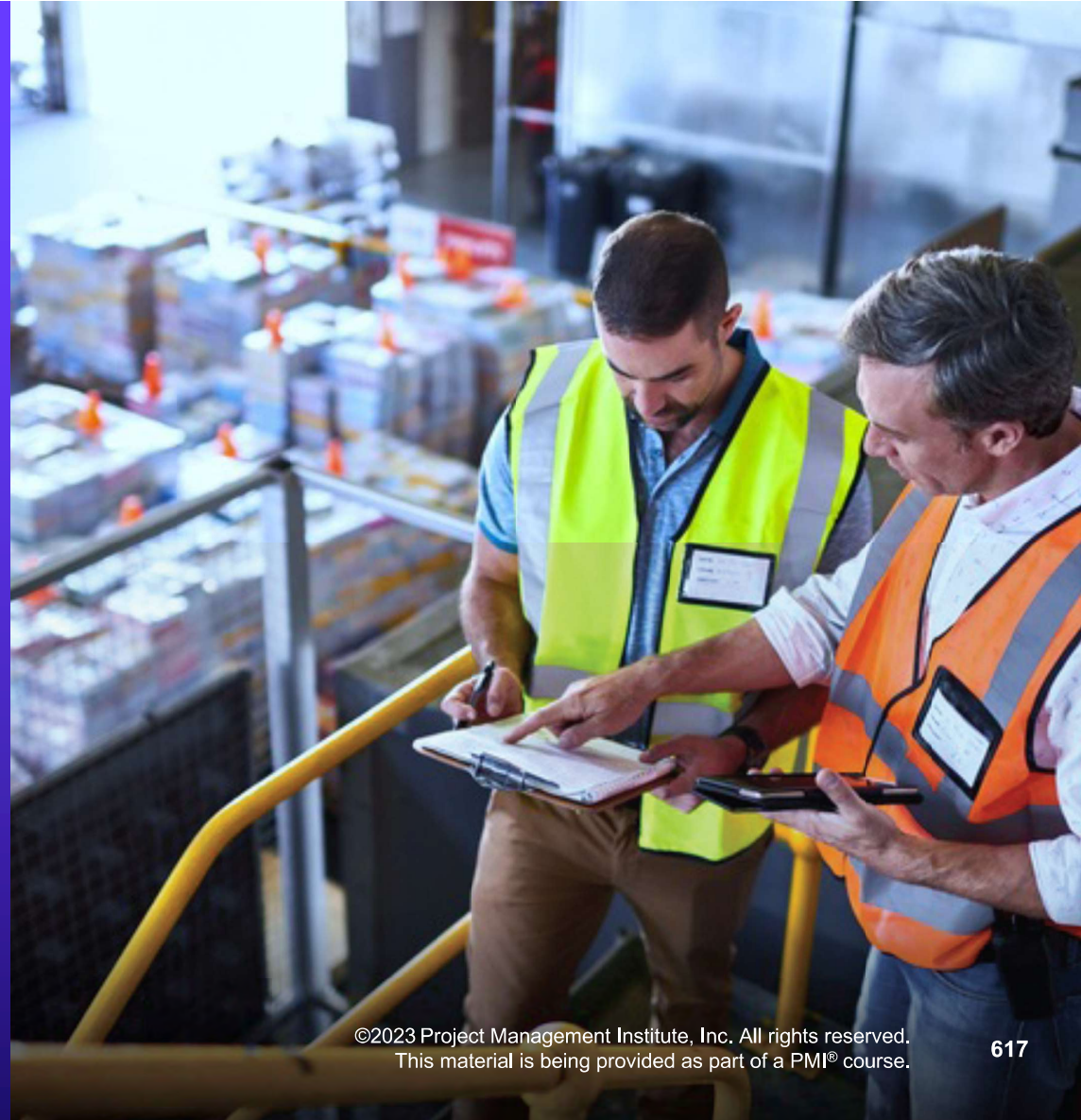

Data Visualization

Quality Tool - Cause and Effect Diagram

Break down the problem statement to identify causes in discrete branches

Keep asking “why” to help identify the main or root cause of the problem

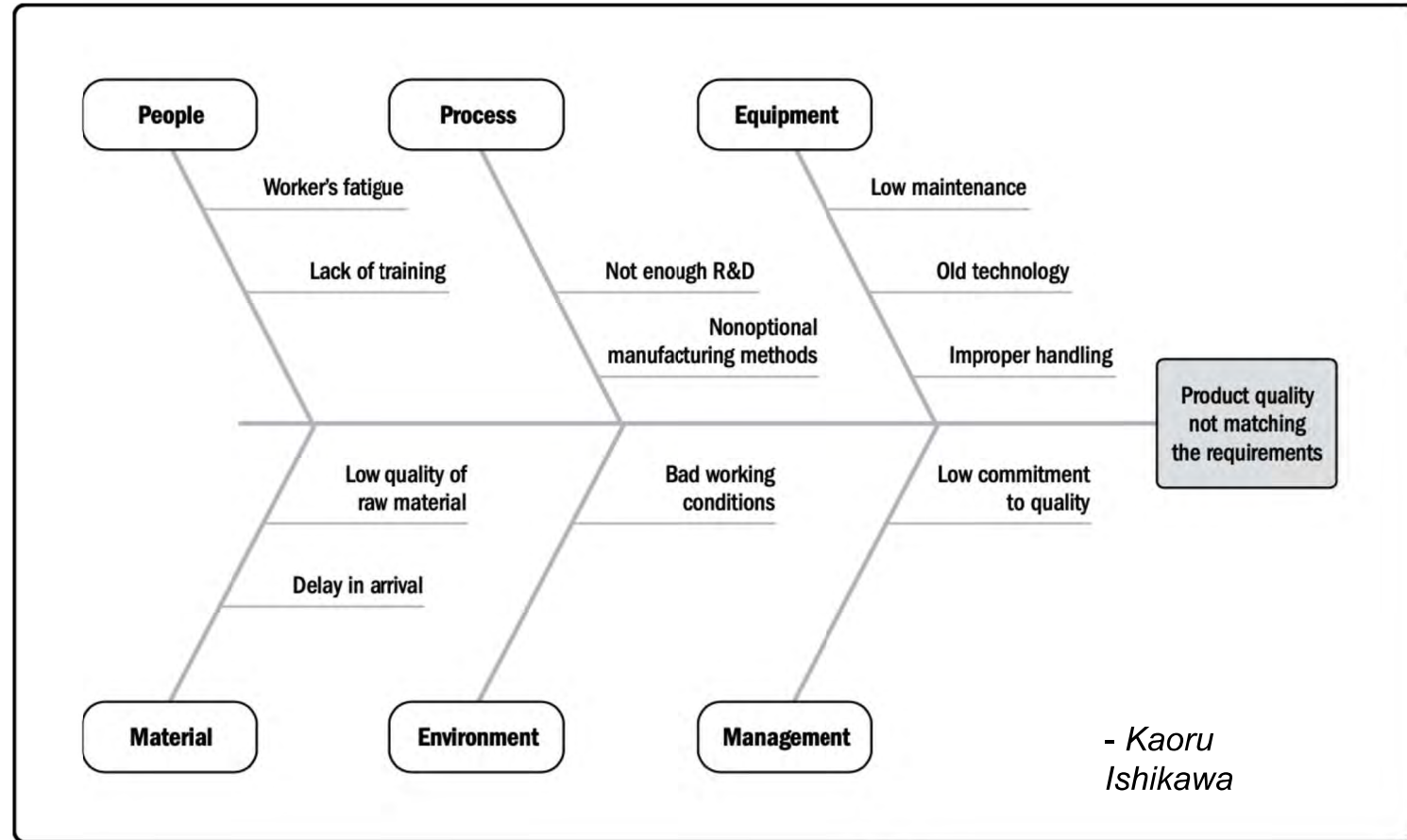

Example fishbone diagram (aka Ishikawa or Why-Why)

Data Visualization Quality Tool Scatter Diagram

Shows the relationship between two variables

Demonstrates relationships among any element of a process, environment, or activity on one axis and a quality defect on the other

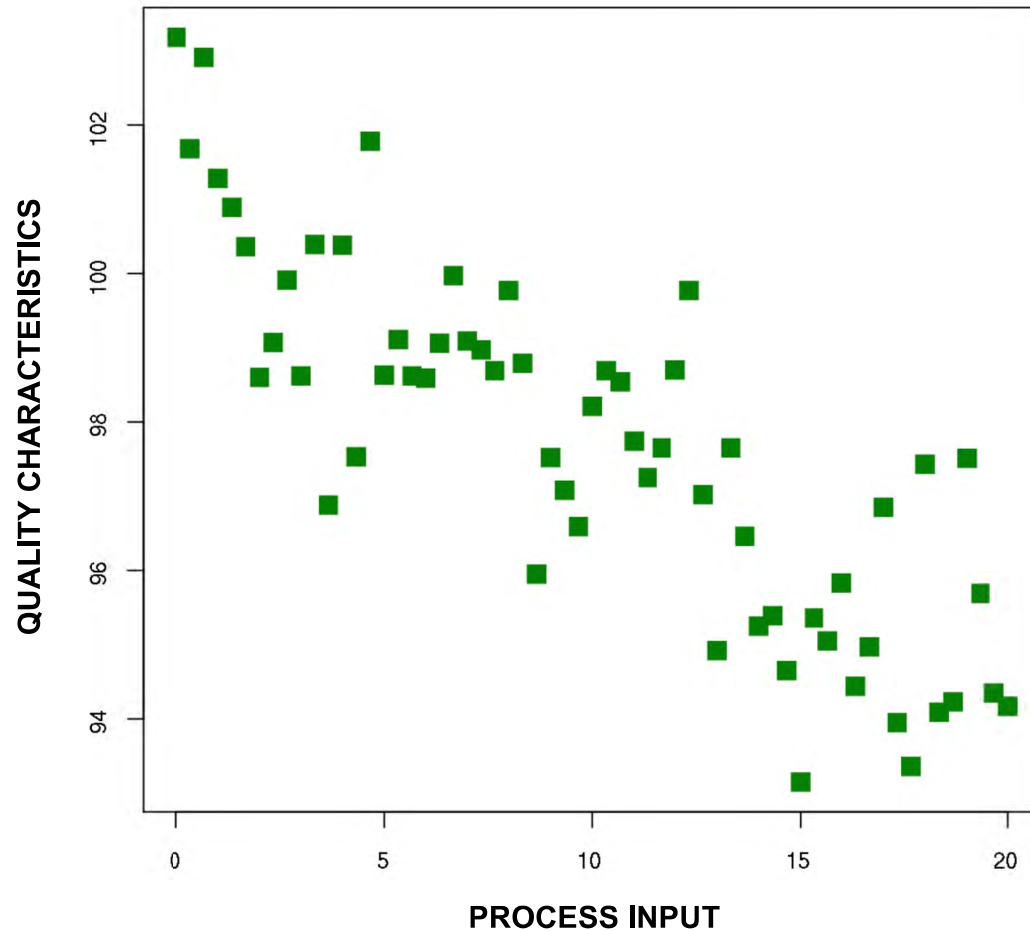

Data Visualization Quality Tool

Control Chart

- A tool used to determine the predictability, behavior and stability of a process over time
- Ideal for repetitive processes with predictable results
- Shows a **mean** and established **control limits** and **specification limits**
- Follow the “rule of seven” = investigate increases/decreases of seven consecutive points, indicating a trend/potential issue

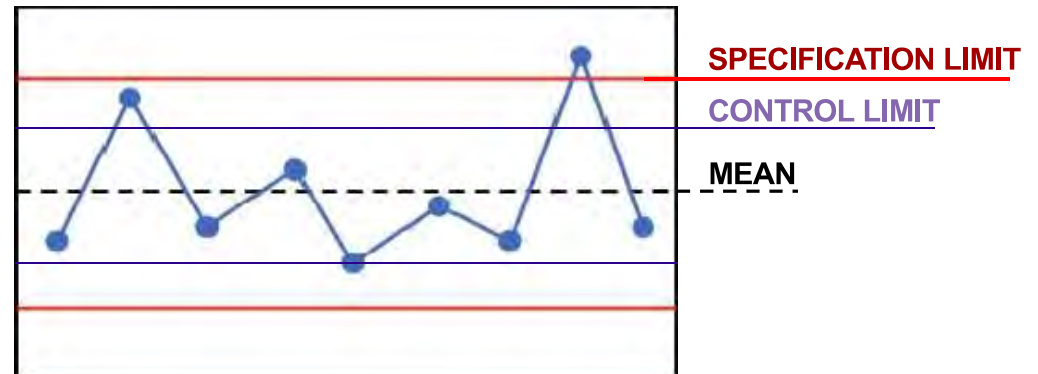

Data Visualization Quality Tools

Histogram and Pareto Chart

- A Pareto chart is a type of **histogram**
- Uses **80/20 rule**
- Demonstrates frequency of problem occurrence
- Analyzes data sets related to a specific problem or issue, but does not define the root cause of a problem

Results of Oasestown Residents Survey

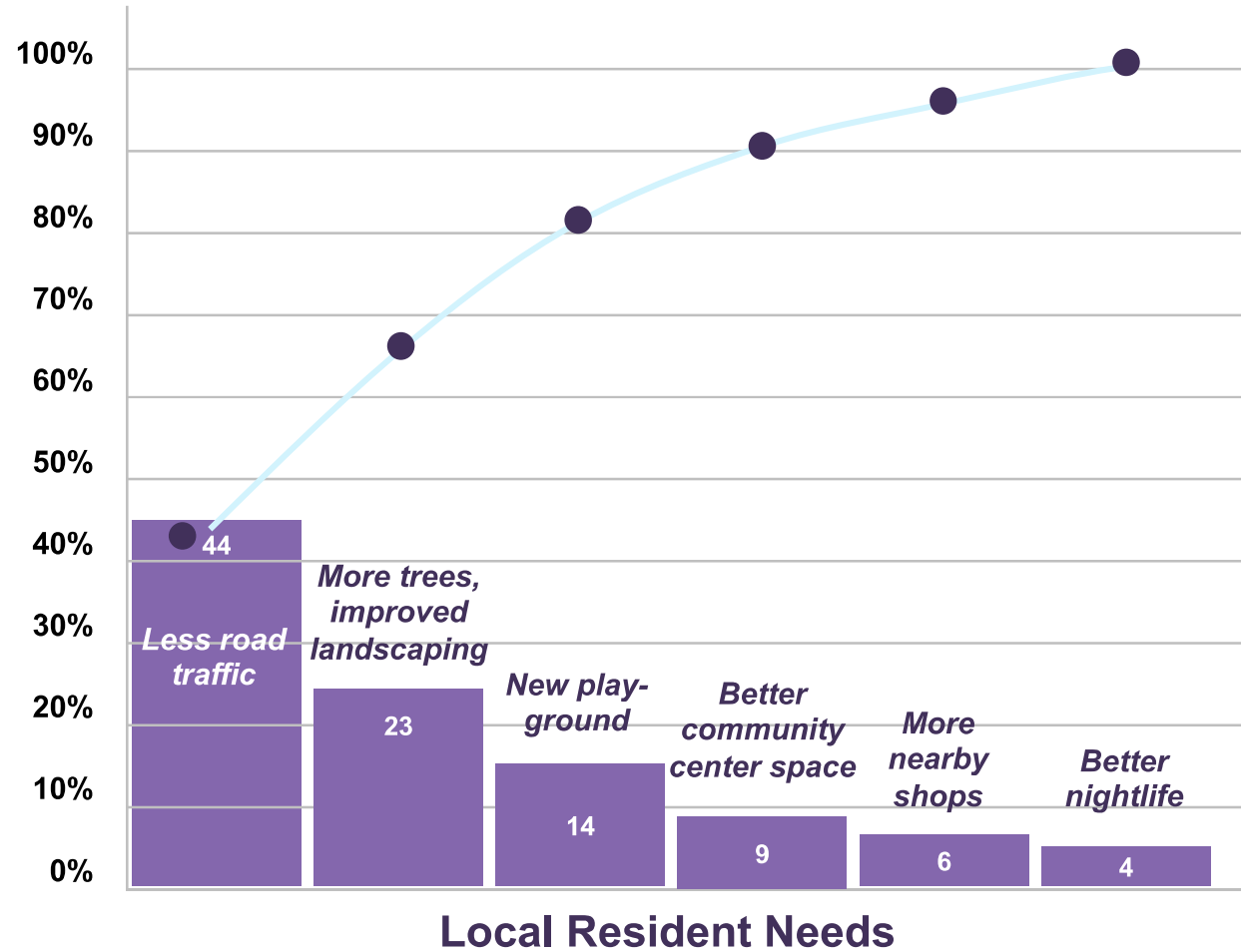

HISTOGRAM

A bar or column chart that graphically represents numerical data—for example, the number of defects per deliverable, a ranking of the cause of defects, the number of times each process is noncompliant, or other representations of project or product defects.

80/20 RULE

A general guideline with many applications; in terms of controlling processes, it contends that a relatively large number of problems or defects, typically 80%, are commonly due to a relatively small number of causes, typically 20%. See also “Pareto Chart”.

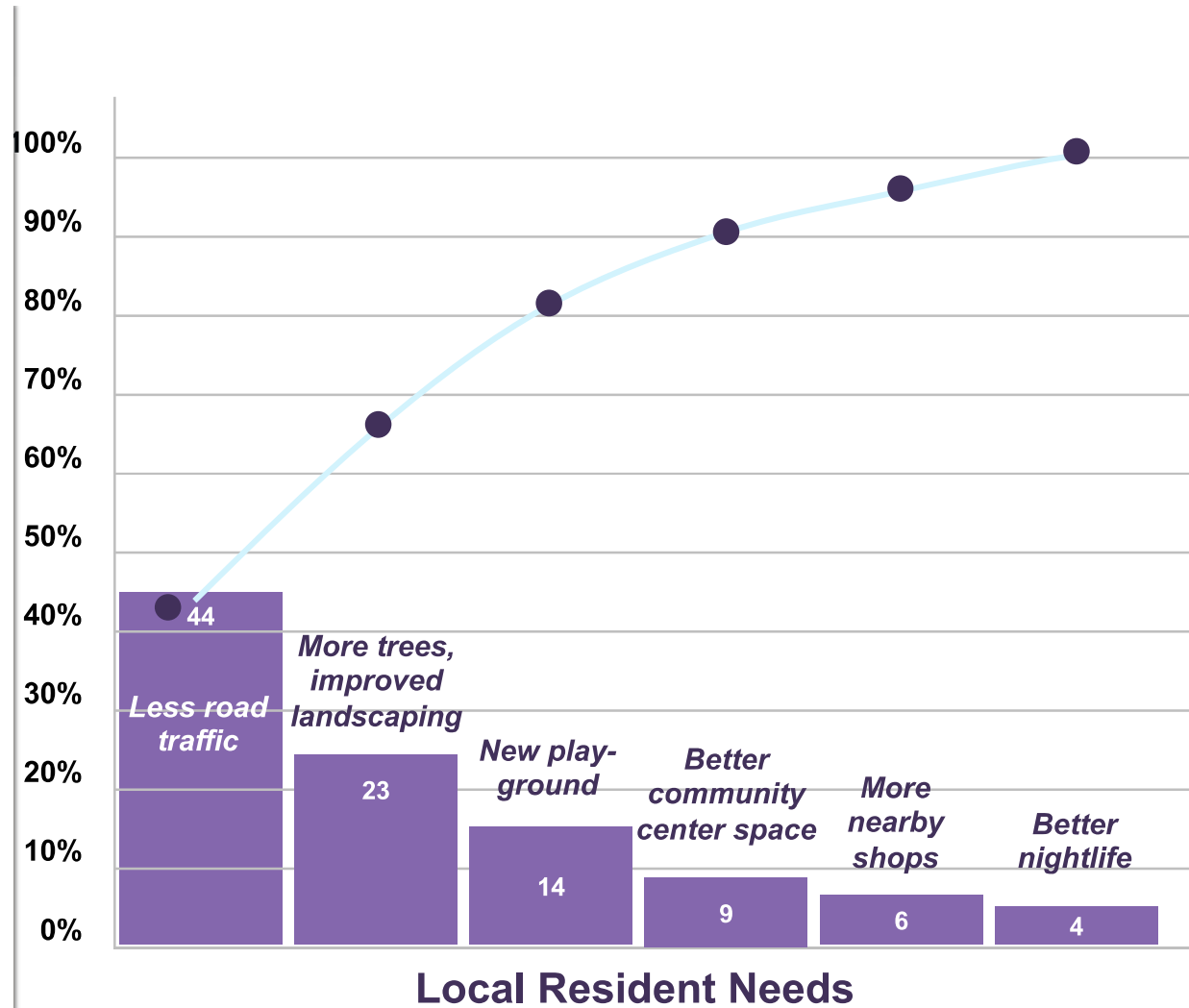

Ensure Quality of Processes and Product

Quality is closely linked to the product acceptance criteria, as described in the statement of work (SOW) or other design documents.

Update these criteria as experimentation and prioritization occur and then validate them as part of the acceptance process.



Verify Deliverables



-
- Project team verifies deliverables based on quality standards and requirements:
 - Quality metrics
 - Tolerance
 - The verified deliverables are presented to and accepted (validated) by the customer – resulting in accepted deliverables
 - Measure products and outputs against the project’s quality standards
 - Implement corrections and controls when quality standards are neither met nor within acceptable ranges
 - Iteration H (agile) – quality assurance cycle
 - Sprint/iteration review in Scrum

Evaluate and Manage Risk



Adaptive development approaches incorporate risk management in iterative and incremental practices.



Predictive risk management approaches are methodical.



(Optional)

Can you identify some typical risk management practices or use cases for each approach?

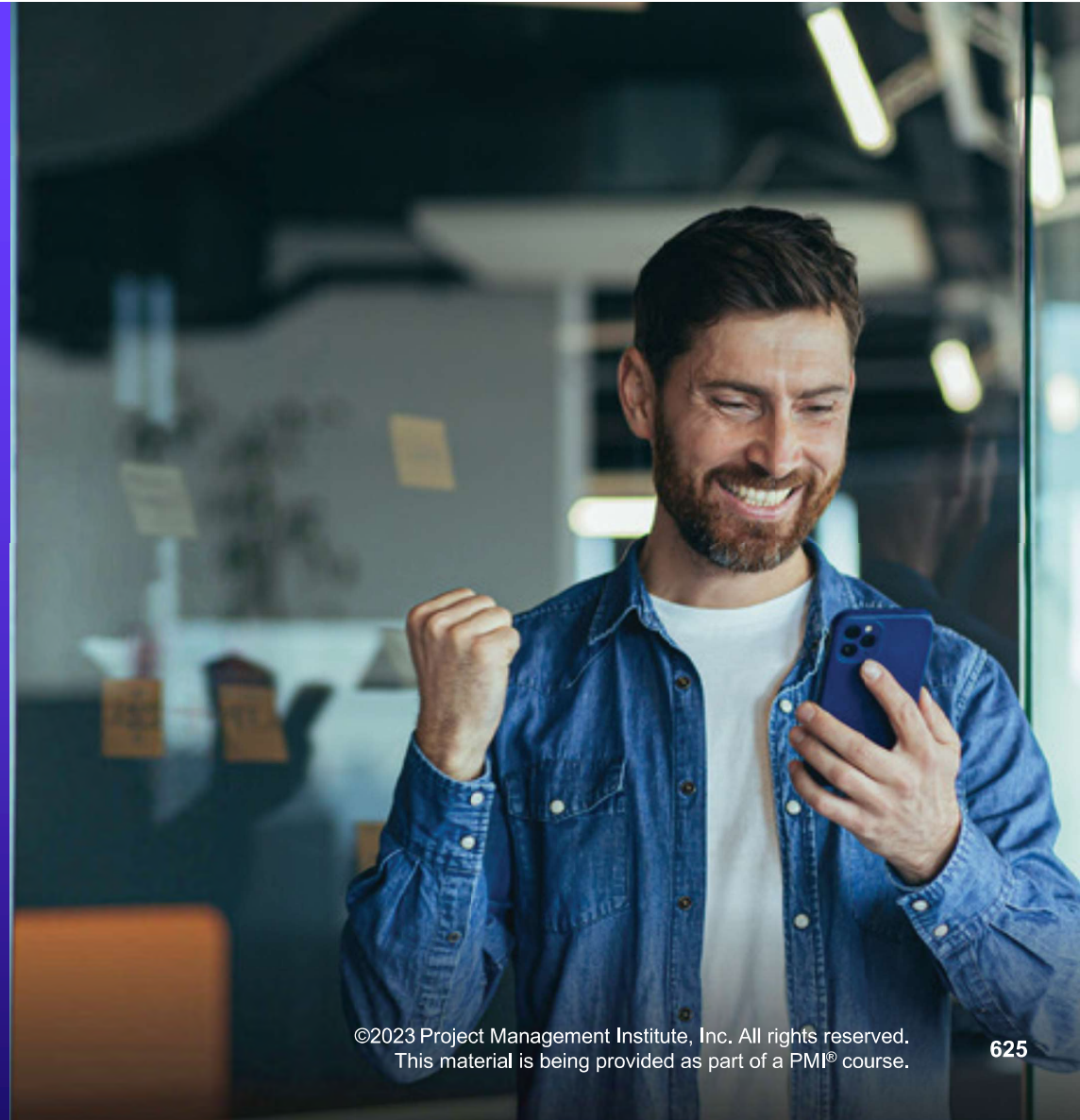

Monitor Risks



GUIDELINES

- Enable decision-making based on current information about overall risk exposure and individual risks
- Continuously monitor status, probability and impact
- Identify new risks
- Reassess current risks
- Close outdated risks
- Perform on a regular basis
- Continuously improve risk effectiveness

QUESTIONS TO ASK

- Are project assumptions still valid?
- Have risks changed or been retired?
- Are risk management policies and procedures being followed?
- Have contingency reserves been modified?
- Do we need a risk audit?

Review your Reserves

Reserve analysis:

- Establishes the amount of contingency and management reserves needed
- Is performed throughout the project
- Compares amount remaining to determine if adequate
- May be communicated with a burndown chart



RESERVE ANALYSIS

A method used to evaluate the amount of risk on the project and the amount of schedule and budget reserve to determine whether the reserve is sufficient for the remaining risk.

Reserve analysis:

- Establishes the amount of contingency and management reserves needed
- Is performed throughout the project
- Compares amount remaining to determine if adequate
- May be communicated with a burndown chart

Risk Register

- Add risks raised during status meetings, standups or daily scrums, iteration reviews, retrospectives – or even informally – to the risk register
- Update newly identified and existing risks based on the current knowledge and situation



Agile teams may use a risk list or log, similar to a risk register

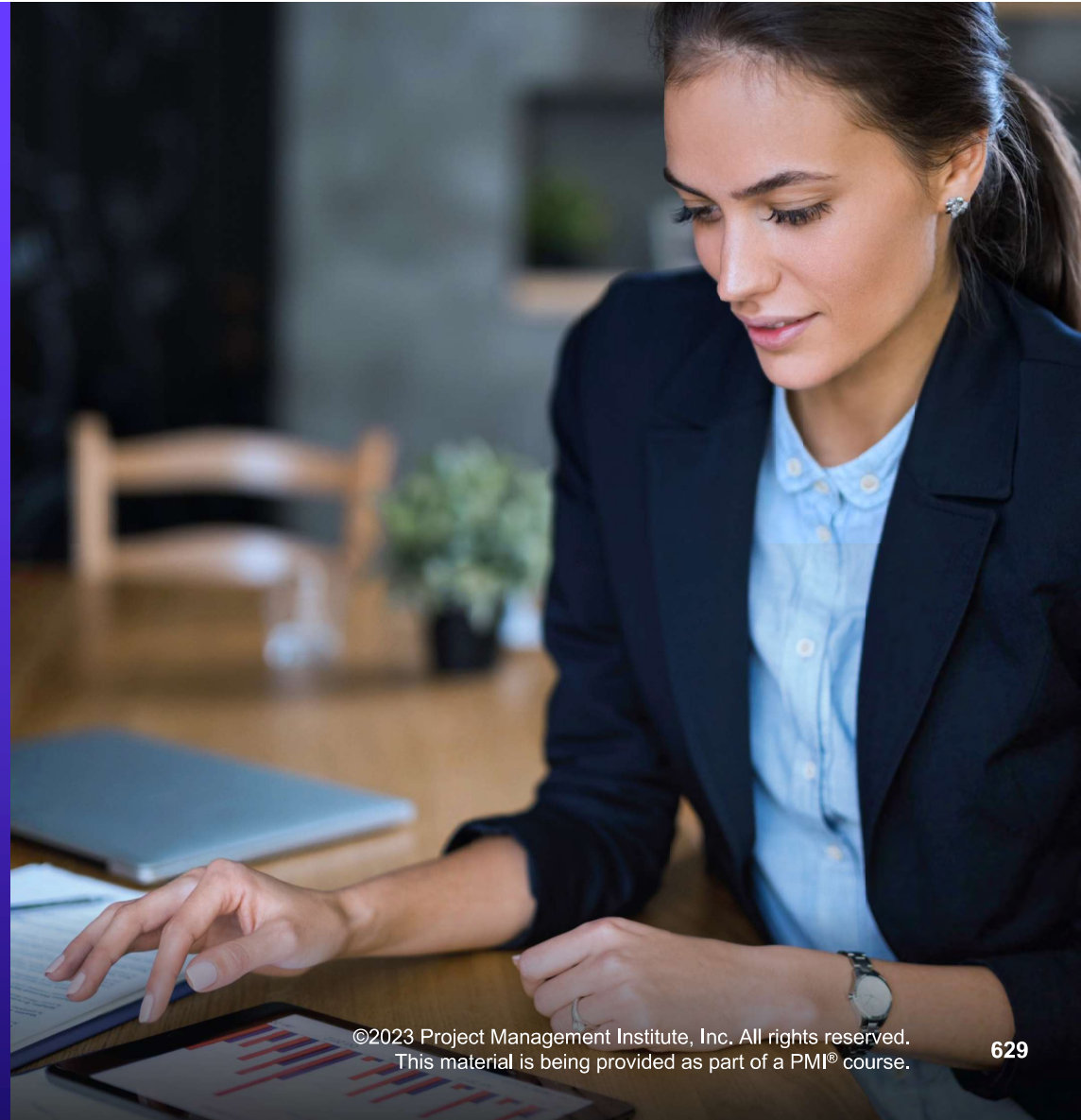

Interactive/Discussion



*When you think about risks in a project,
which do you think are the most serious?*

How do you know?



Manage Compliance as the Highest Priority

-
- Test and validate deliverables (continuously and at project/ phase end)
 - Identify authorized stakeholders to approve
 - Remediate compliance issues to avoid:
 - Negative impact on the timeline
 - Cost overruns
 - Increased risks
 - Benefits of compliance sign-off:
 - Early warning of potential threats to compliance
 - Ability to capture variances and take action

Examine Business Value

- Connects Ways of Working with Business Acumen
- Tailor work processes, approaches and tools along with leadership skills to examine and improve value delivery



How often and how well does your project team really focus efforts on examining the business value of the project?



ECO Coverage

2.8 Plan and manage scope

- Monitor and validate scope (2.8.3)

2.6 Plan and manage schedule

- Measure ongoing progress based on methodology (2.6.4)
- Modify schedule, as needed, based on methodology (2.6.5)
- Coordinate with other projects and other operations (2.6.6)

2.5 Plan and manage budget and resources

- Monitor budget variations and work with governance process to adjust as necessary (2.5.3)

2.1 Execute project with the urgency required to deliver business value

- Examine the business value throughout the project (2.1.2)

2.7 Plan and manage quality of products/deliverables

- Continually survey project deliverable quality (2.7.3)
- Recommend options for improvement based on quality gaps (2.7.2)

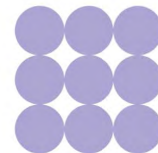
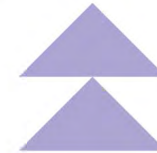
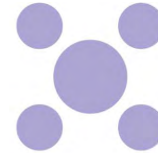



Manage Project Issues and Impediments

TOPIC D

Problem Vocabulary

Impediments, Obstacles and Blockers

Obstacle removal. Since it is the project team who generates the majority of business value, a critical role for the servant leader is to maximize delivery by removing **impediments** to their progress. This includes solving **problems** and removing **obstacles** that may be hampering the project team's work. By solving or easing these **impediments**, the project team can deliver value to the business faster.

Remove obstacles (*Step 5 in the Process for Leading Change*)

All change comes with **obstacles**. Sometimes the **obstacles** are outdated processes, sometimes they are based on the organizational structure, and sometimes they are people resistant to change. Regardless, all **obstacles** need to be addressed.

- *PMBOK® Guide – 7th Edition*



*'Impediment' and 'blocker' are synonyms; they both mean, "an **obstacle** that prevents the team from achieving its objectives."*

Issue or Impediment? Just Solve the Problem!

-
- **Issue:** A condition or situation that may have an impact on the project objectives.
 - **Impediment:** An obstacle that prevents the team from achieving its objectives. Also known as a blocker.



Predictive teams use the term issue log



Adaptive teams tend to use an impediment log.



This term is related to Scrum.

Risks and Issues



- Focused on the future
- Can be positive or negative
- Are documented in the risk register
- Response is called a “risk response”

- Focused on the present
- Will always be negative
- Are documented in the issue log
- Response is called a “workaround”

Issues

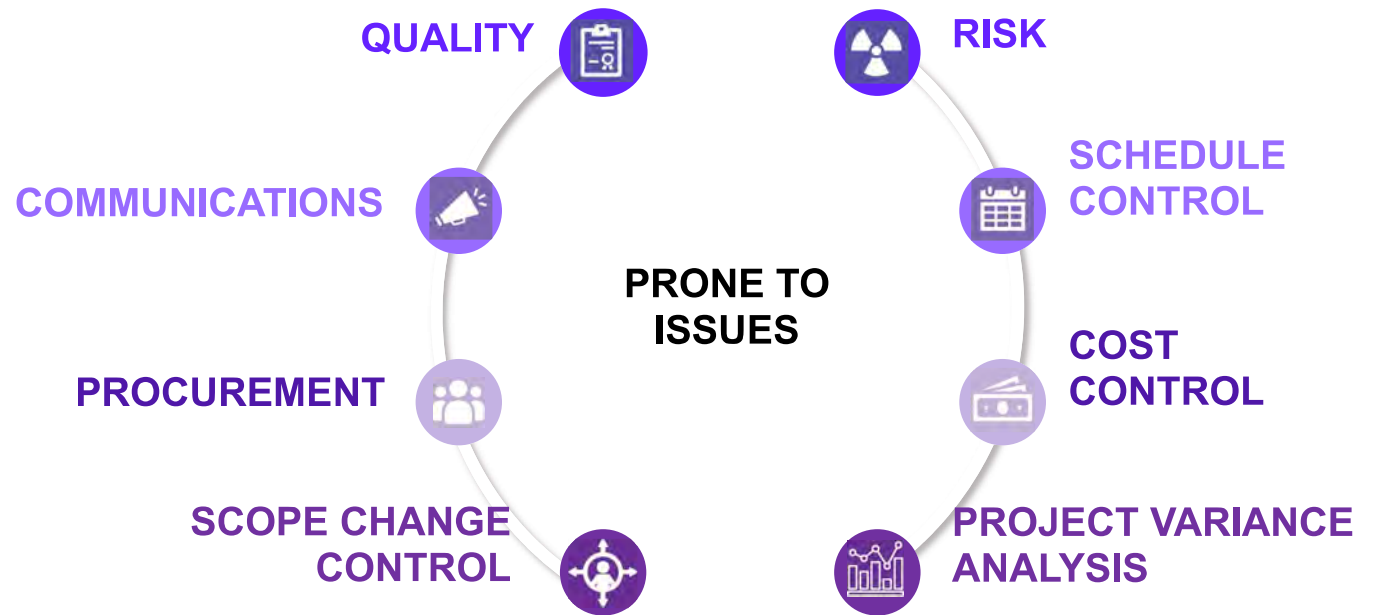

Issue Resolution Guidelines

Track problems, inconsistencies or conflicts and conduct investigation towards resolution



- As issues arise, promptly add them to the **issue log**.
- Assign an owner to each issue
- Give realistic due dates
- Discuss issues at every status meeting
- Limit open issues to a manageable number
- Don't hesitate to escalate if effects are major!

ID	Description	Opened	Due Date	Priority	Owner	Response	Status	Comments
25	Truck strike	15 Jan 20xx	01 Feb 20xx	High	A. Fen	TBD	Open	Tasks are on the critical path
26	Glazing service down	15 Jan 20XX	01 Feb 20xx	Med	Gen Contractor	working	open	Looking into another supplier
27	Josie Bynoe dissatisfied	15 Jan 20xx	01 Feb 20xx	High	A. Fen	working	open	Risks board withholding operating funds

ISSUE LOG

An issue is a current condition or situation that may have an impact on the project objectives. An issue log is used to record and monitor information on active issues. Issues are assigned to a responsible party for follow up and resolution.



- As issues arise, promptly add them to the **issue log**.
- Assign an owner to each issue
- Give realistic due dates
- Discuss issues at every status meeting
- Limit open issues to a manageable number
- Don't hesitate to escalate if effects are major!

ID	Description	Opened	Due Date	Priority	Owner	Response	Status	Comments
25	Truck strike	15 Jan 20xx	01 Feb 20xx	High	A. Fen	TBD	Open	Tasks are on the critical path
26	Glazing service down	15 Jan 20XX	01 Feb 20xx	Med	Gen Contractor	working	open	Looking into another supplier
27	Josie Bynoe dissatisfied	15 Jan 20xx	01 Feb 20xx	High	A. Fen	working	open	Risks board withholding operating funds

Discover and Solve Impediments Using Scrum

Steps:

- Discover the problem/cause
- Solve it. The scrum master is responsible for finding a resolution with concerned parties:
 - Often involves dealing with conflict somewhere in the organization
 - Resolution can help the organization grow in agility



Remove Impediments

Overview

- Track impediments
- Reprioritize product backlog
- Use daily standup meeting
- Be a servant leader



Discussion



How does your team solve problems?



Objetivos 2022 (Personales)
Gym.
Comer mejor
Usar bici
Business/Market
Viajar
Crear nuevo negocio
Family

lectura online
Coaching
... a un...

ECO Coverage

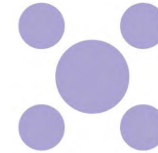

2.15 Manage project issues

- Recognize when a risk becomes an issue (2.15.1)
- Attack the issue with the optimal actions to achieve project success (2.15.2)
- Collaborate with relevant stakeholders on the approach to resolve the issues (2.15.3)

1.7 Address and remove impediments, obstacles, and blockers for the team

- Determine critical impediments, obstacles, and blockers for the team (1.7.1)
- Prioritize critical impediments, obstacles, and blockers for the team (1.7.2)
- Use network to implement solutions to remove impediments, obstacles, and blockers for the team (1.7.3)
- Re-assess continually to ensure impediments, obstacles and blockers for the team are being addressed (1.7.4)

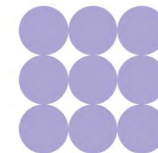



Manage Project Changes

TOPIC E

Interactive/Discussion

- *What constitutes a change in a project?*
- *Can a change can come from anywhere?*
- *How does the life cycle and development approach affect our response to change?*



Causes of Project Changes

- Inaccurate initial estimates
- New regulations
- Missed requirements
- Specification changes



Are any of these also causes of changes in adaptive projects?

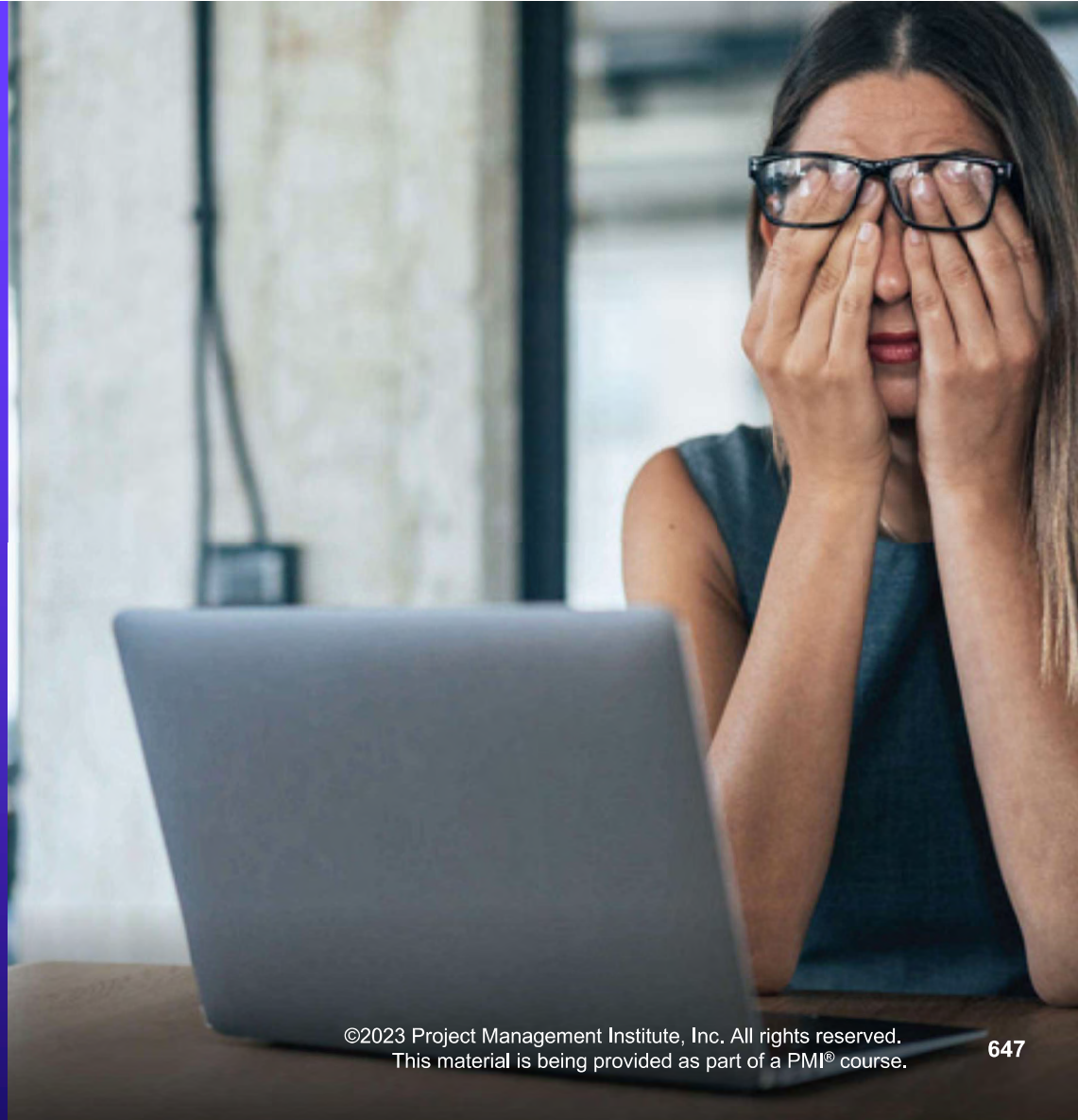

Be a Changemaker and a Change Leader



Which of the project management principles deal with the subject of change?

- a. Be a diligent, respectful and caring steward
- b. Recognize, evaluate and respond to system interactions
- c. Navigate complexity
- d. Create a collaborative project team environment
- e. Demonstrate leadership behaviors
- f. Optimize risk responses
- g. Effectively engage with stakeholders
- h. Tailor based on context
- i. Embrace adaptability and resiliency
- j. Focus on value
- k. Build quality into processes and deliverables
- l. Enable change to achieve the envisioned future state



Monitor the External Business Environment

Change can bring negatives as well as positives, such as opportunities to add or extend value!



- Monitor the external environment
- Remain vigilant for threats
- Constantly update the risk register and thresholds
- Use tools



- PESTLE
- TECOP
- VUCA

Manage Change

Overview and Controls

Overview	Controls
Perform Integrated Change Control linear process 	<ul style="list-style-type: none"> • Perform Integrated Change Control process • Change request process • Change control board (CCB) • Artifact management (updates)
Feedback and development cycle 	<ul style="list-style-type: none"> • Product owner role - key decision maker and runs backlog • Everyone participates in backlog refinement • Use demos to understand requirements • No changes allowed during a sprint
Any of the above 	

Change Management Process Flowchart

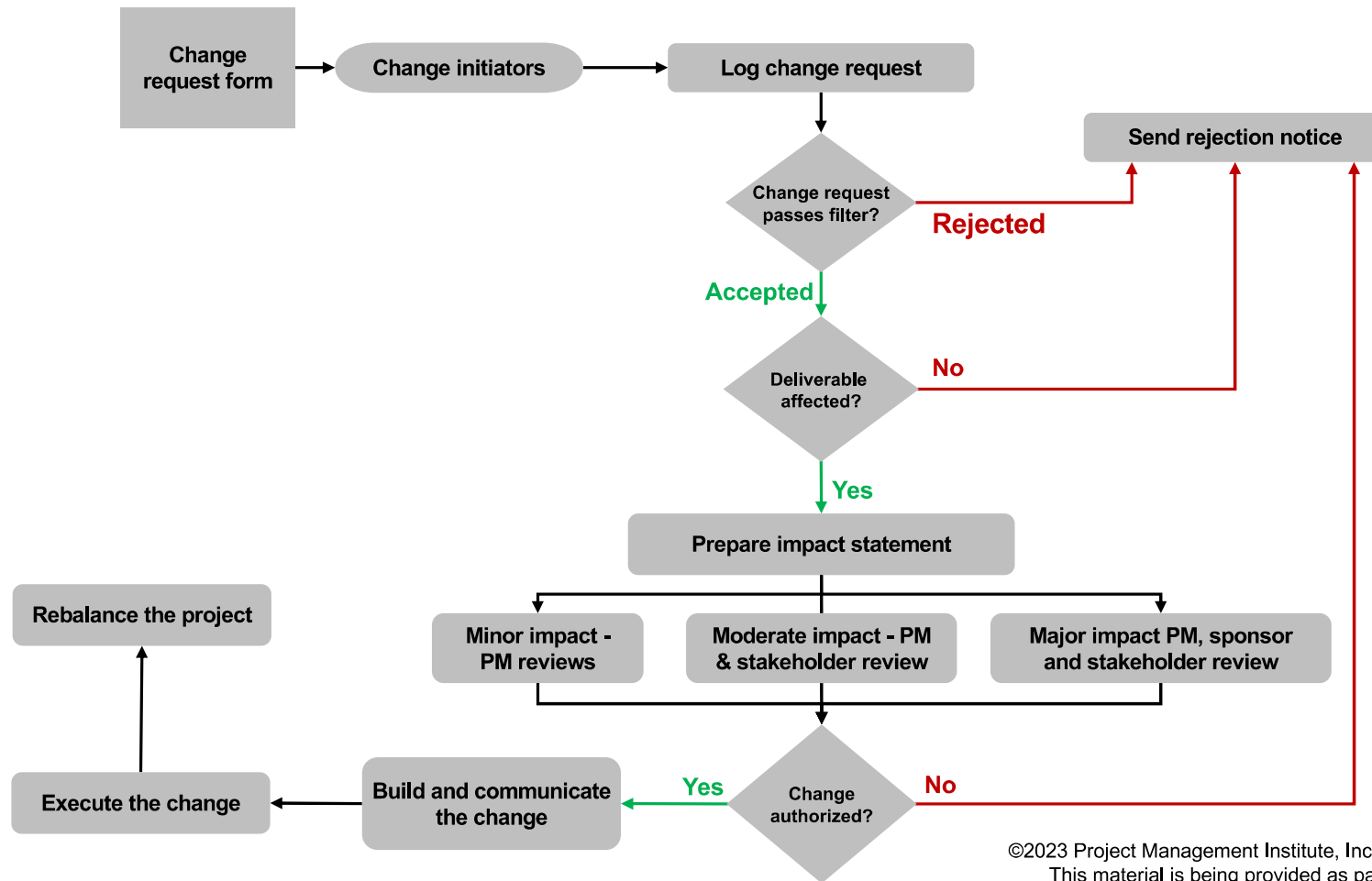

Change Requests

Four Types



Can you think of examples of each kind for the Shawpe project?



-
- **Corrective action** - Adjusts the performance of the project work with the project management plan
 - **Preventive action** - Ensures future performance of the project work with the project management plan
 - **Defect repair** - Modifies a nonconformance within the project
 - **A change** - Modifies a project baseline

Change Control Systems

Change Control Board

Forms, tracking methods, processes, and approval levels required for authorizing or rejecting requested changes.

One approval level may be the **Change control board (CCB)** which handles *some* change requests based on the approval levels documented in the change management plan.



CHANGE CONTROL BOARD (CCB)

A formally chartered group responsible for reviewing, evaluating, approving, delaying, or rejecting changes to the project and for recording and communicating such decisions.

Forms, tracking methods, processes, and approval levels required for authorizing or rejecting requested changes.

One approval level may be the **Change control board (CCB)** which handles *some* change requests based on the approval levels documented in the change management plan.

Manage Contract Changes and Resolve Problems

-
- Work with the vendor to manage contract changes
 - Work with partners in the organization (procurement, finance, functional departments) and take action within the project manager's or team's domain/threshold
 - Legal problems that are serious enough to cause issues may need expert help

Contract Change Control System

The system used to collect, track, adjudicate and communicate changes to a contract



-
- Might be a component of the integrated change control or a separate organizational system
 - Specifically dedicated to control contract changes
 - Specifies contract change
 - Includes documentation, dispute-resolution processes and approval levels

Types of Contract Changes



Which kinds of changes do you think are more likely to cause conflict? Why? How can these be avoided?

Component	Description
Administrative changes	Non-substantive changes, usually about contract administration method
Contract modification	Substantive change to contract requirements or product requirements
Supplemental agreement	An additional agreement related to the contract but negotiated separately
Constructive changes	Changes made by the buyer through action or inaction
Termination of contract	Vendor default or buyer's need changes

Legal Concepts When Managing Disputes



Seek legal advice if the terms of a contract have not been met.

Negotiate settlements to arrive at a final equitable settlement of all outstanding issues, claims, and disputes by negotiation.

Legal Issue	Description
Warranty	A promise, explicit or implied, that goods or services will meet a pre-determined standard. The standard may cover reliability, fitness for use, and safety.
Waiver	A legally binding provision in which one party in a contract agrees to forfeit a claim without the other party becoming liable, even inadvertently.
Breach of contract	Failure to meet some or all the obligations of a contract. It may result in damages paid to the injured party, litigation or other ramifications.
Cease and desist (C&D) letter	A letter sent to an individual or a business to stop (cease) allegedly illegal activities and to not undertake them again (desist). Often used as a warning of impending legal action if it is ignored.

Process, Adjudicate and Communicate Claims

-
- Contested changes and potential constructive changes, including:
 - Lack of agreement on compensation for change
 - Lack of agreement that change occurred
 - If not resolved, handle through alternative dispute resolution (ADR) established in contract
 - Settlement through negotiation is preferred
 - The "last resort" is litigation

Update Project Management Plan

Based on the scope of changes, you may need to update:

- Scope
- Timelines
- Work packages
- Team member assignments



Agile teams might remove lower-value deliverables from the scope to make room for the change.

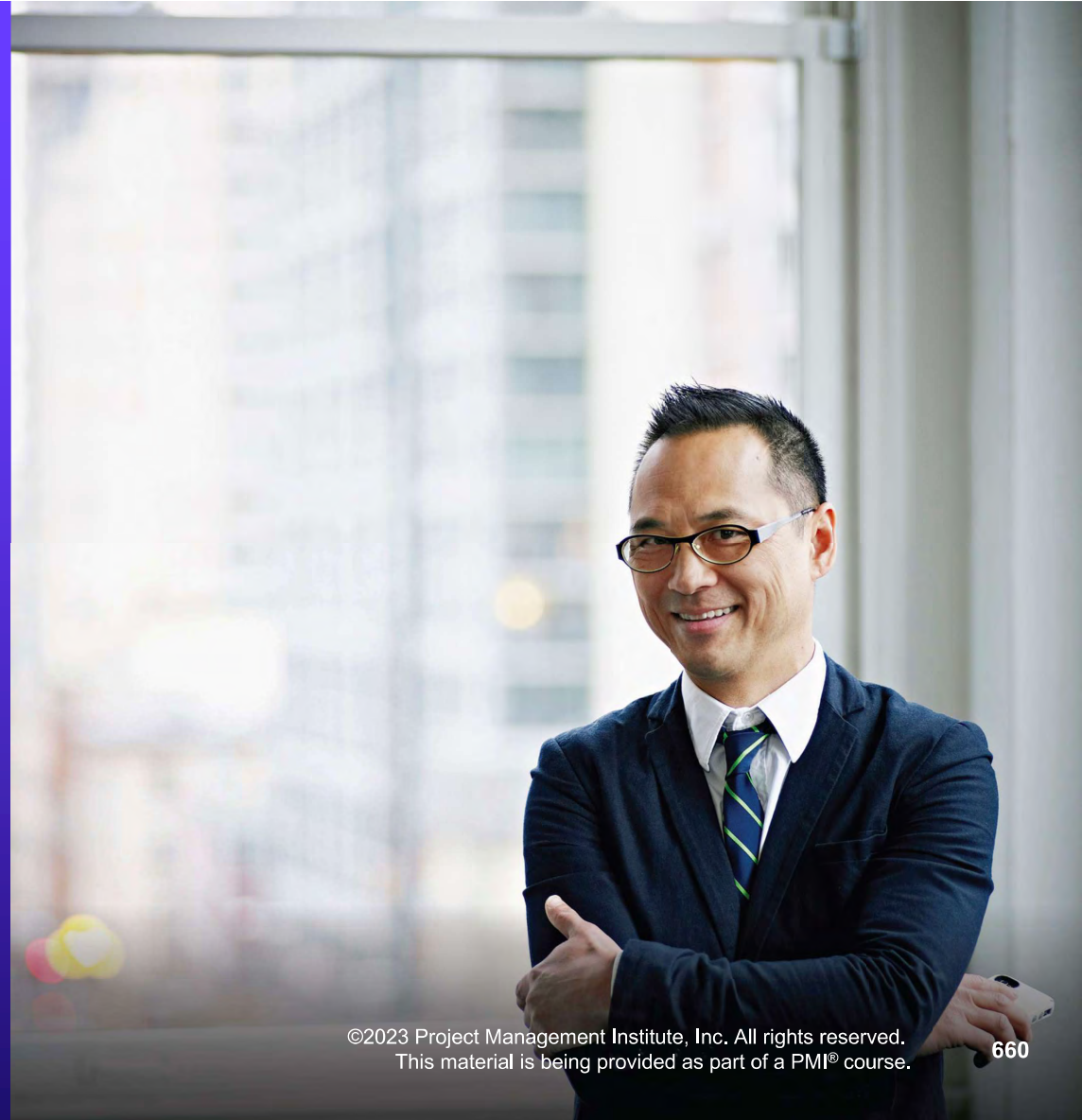

ECO Coverage

3.3 Evaluate and address external business

environment changes for impact on scope

- Survey changes to external business environment (e.g., regulations, technology, geopolitical, market) (3.3.1)
- Assess and prioritize impact on project scope/backlog based on changes in external business environment (3.3.2)
- Recommend options for scope/backlog options (e.g., schedule, cost changes) (3.3.3)
- Continually review external business environment for impacts on project scope/backlog (3.3.4)

2.10 Manage project changes

- Anticipate and embrace the need for change (e.g., follow change management practices (2.10.1)
- Execute change management strategy according to the methodology (2.10.3)
- Determine a change response to move the project forward (2.10.4)

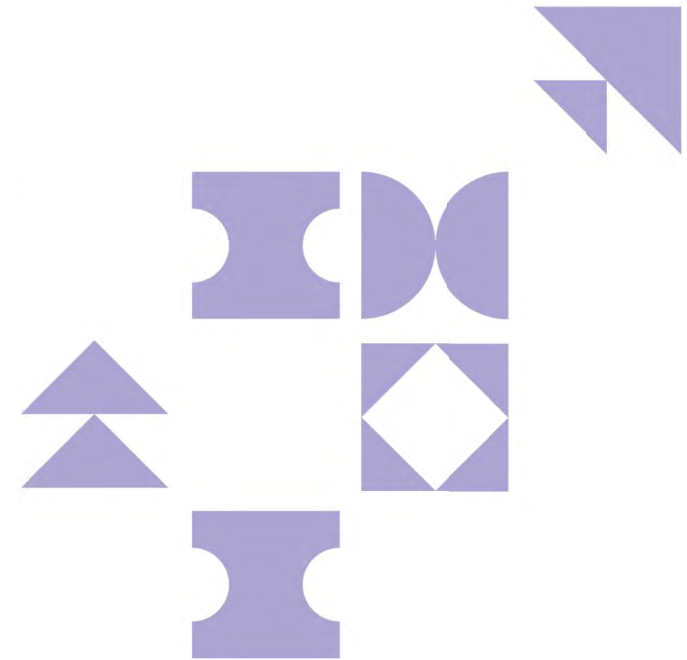

LESSON 6

CLOSE THE PROJECT/PHASE

- Project/Phase Closure
- Benefits Realization
- Knowledge Transfer

Version 3.2 | 2023 Release



Learning Objectives

- Define the reasons and activities related to the closure of a phase or a project.
- Explain the benefits gained from a project or phase, and how they are managed, sustained, etc.
- Examine the reasons for knowledge transfers and how they relate to the closure of a phase or project.

Project Life Cycle Check-In

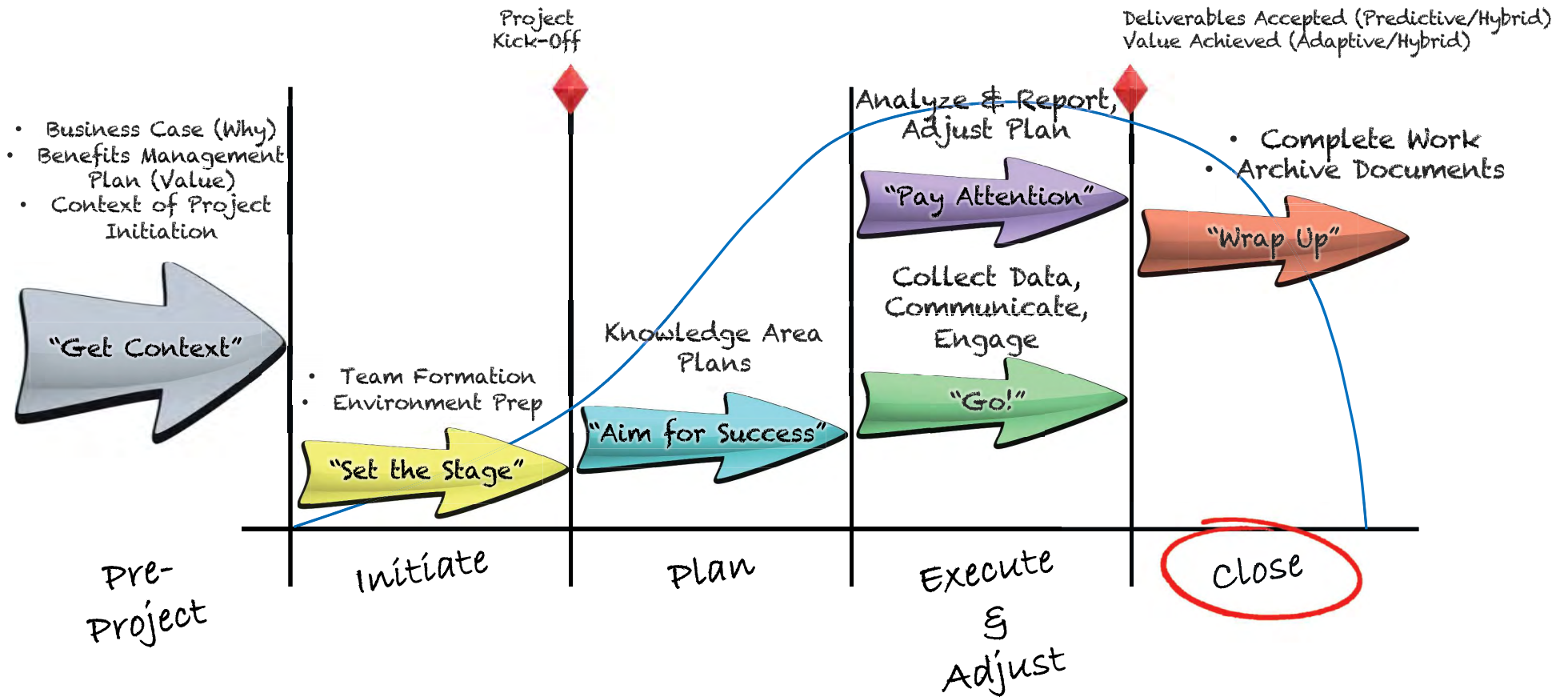



Project/Phase Closure

TOPIC A

Why Projects or Phases Close Fulfillment



Stakeholders accept deliverables based on **acceptance criteria** established at the beginning of the project in the **project management plan**

Acceptance criteria may be modified during a project life cycle

Use the **requirements traceability matrix** to ensure completion and approval of all requirements



At the end of an iteration, the team and stakeholders assess the product/service against their mutually agreed **definition of done (DoD)**

Final acceptance occurs prior to product release.



Acceptance criteria and definition of done (DoD) express the same status of stakeholder satisfaction with the product. Teams may use the terms interchangeably.

ACCEPTANCE CRITERIA

A set of conditions that is required to be met before deliverables are accepted.

DEFINITION OF DONE (DoD)

A team's checklist of all the criteria required to be met so that a deliverable can be considered ready for customer use.



Stakeholders accept deliverables based on **acceptance criteria** established at the beginning of the project in the **project management plan**

Acceptance criteria may be modified during a project life cycle

Use the **requirements traceability matrix** to ensure completion and approval of all requirements



At the end of an iteration, the team and stakeholders assess the product/service against their mutually agreed **definition of done (DoD)**

Final acceptance occurs prior to product release.



Acceptance criteria and definition of done (DoD) express the same status of stakeholder satisfaction with the product. Teams may use the terms interchangeably.

Why Projects or Phases Close

Premature or Forced Closure



Can anyone share an example of a forced project or phase closure?

-
- Requirements/needs change
 - Project/deliverable is no longer feasible
 - (Internal) Organization makes a change to the business case.
 - (External) A legal or regulatory change prohibits progress.
 - Project/deliverable is no longer desirable
 - Impediment encountered
 - Financial support is not available to complete the requirements
 - Risks with significant consequences make successful completion impossible

Close Project or Phase Activities

- Acceptance of deliverables or product by customer
- Transition of deliverables or product to customer
- Notify enterprise and organizational functions; update OPAs
- Prepare **final report**
- Conclude external obligations, including legal, regulatory, contractual — e.g., transfer of liability, closure of all accounts in financial system
- Archive project information
- Release resources (human, financial and physical assets)



These activities are part of the Close Project or Phase process and are typically included in the project management plan and in the WBS, under the project management function.

Project or Phase Activities

Final deliverables or product by customer

Final deliverables or product to customer

Close and organizational functions; update OPAs

Final report

Final internal obligations, including legal, regulatory, contractual — e.g., transfer of liability,

Final accounts in financial system

Final project information

Final resources (human, financial and physical assets)

Final project activities are part of the Close Project or Phase process and are typically

defined in the project management plan and in the WBS, under the project

management function.

FINAL REPORT:

A summary of the project's performance, information on performance, scope, schedule, quality, cost, and risks.

Transitions (Handovers)



- Some organizations use a rollout or transition plan.



- *This is **not** a project management plan component.*



Deliverables are handed to the customer or owner.
Transition/handover specifications for deliverables are in the **project management plan**.



A tailored solution that delivers value — most likely in an incremental way — to the organization.



Every iteration output is handed to the product owner.

Transition / Handover Readiness

Ensure your customer is ready for change and success!

Readiness may require additional change management activities to **ensure adoption** and **overcome resistance**.

 *Especially critical if an existing product or service is being upgraded.*

Assess the readiness of all parties:



**End
Users**



**The
Business**



**Project
Team**



**Support
Staff**

Transition / Handover Activities

Effective transitions or handovers of deliverables or products enable end-user awareness, increasing the likelihood of successful adoption and, therefore, of **benefits realization**.

Transition requirements can include:

- Training on the new product or service
- Documentation for the product/deliverable
- Effective communication between the project team and the organization
- Post-implementation support (aka “hypercare”)



Where are the transition requirements recorded in a predictive project?

Interactive / Activity



Do you remember the difference between **explicit** and **tacit** knowledge?

Discuss the importance of transferring both kinds of knowledge from the project team to the customer.

Give an example of how your team has done it in the past.



Paying and Closing Contracts



DO

- Notify the appropriate entity (usually accounts payable) when work has been fulfilled and contracts can be paid
- Pay suppliers or vendors in accordance with contract terms



Some payments may have been made during the project and the contract may have been closed

DON'T

- Delay payments until project or phase closure, unless specified in the contract

Finalizing Contracts

Archiving contracts means collecting, indexing and filing:

- Contract schedule
- Scope
- Quality
- Cost performance
- Contract change documentation
- Payment records and financial documents
- Inspection results
- “As-built” or “as-developed” documents, manuals, troubleshooting and technical documentation

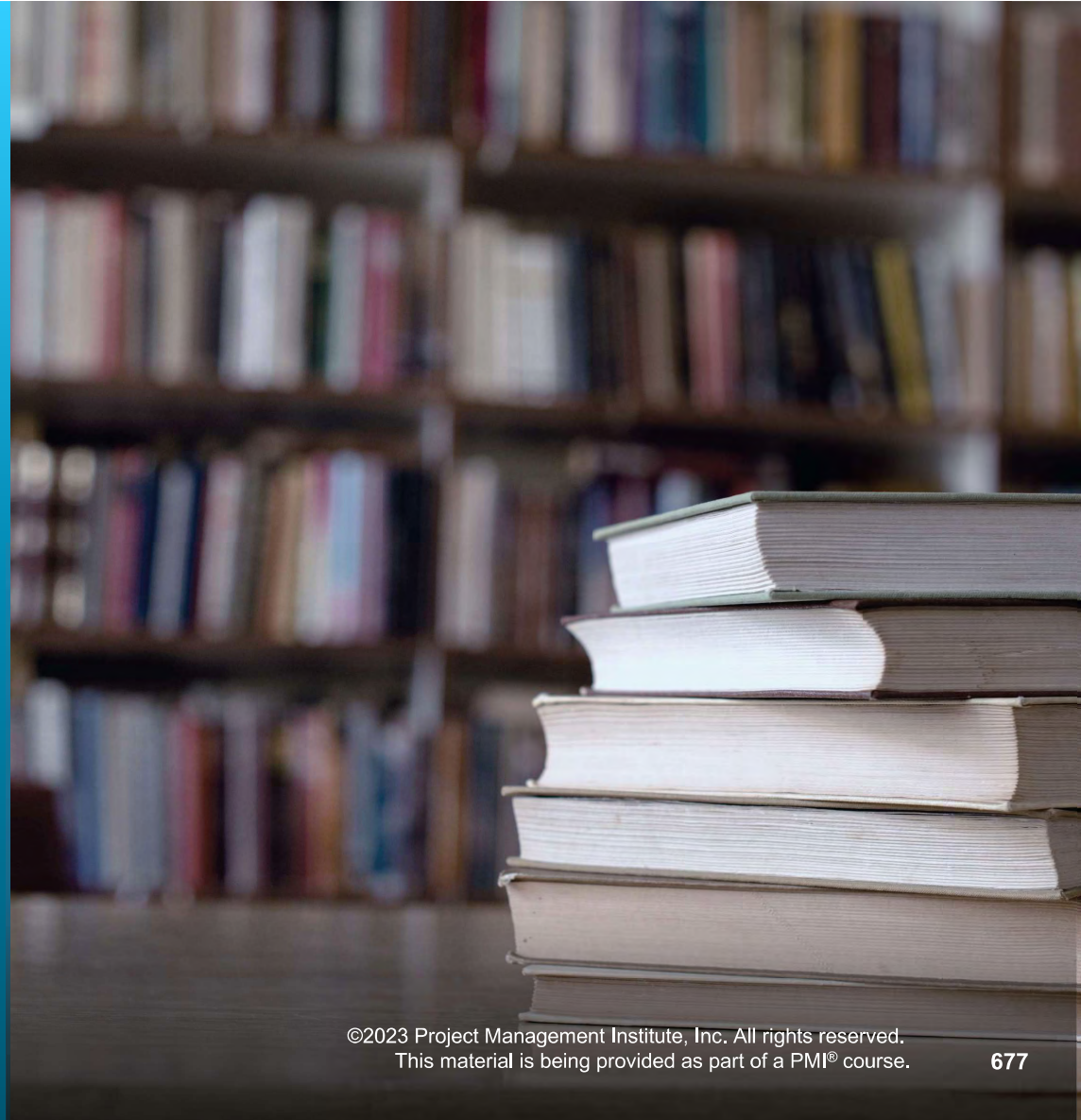

ECO Coverage

1.8 Negotiate project agreements

- Verify objective(s) of the project agreement is met (1.8.3)

2.17 Plan and manage project/phase closure or transitions

- Validate readiness for transition (e.g., operations team or next phase) (2.17.2)
- Conclude activities to close out project or phase (e.g., final lessons learned, retrospectives, procurement, financial, resources) (2.17.3)

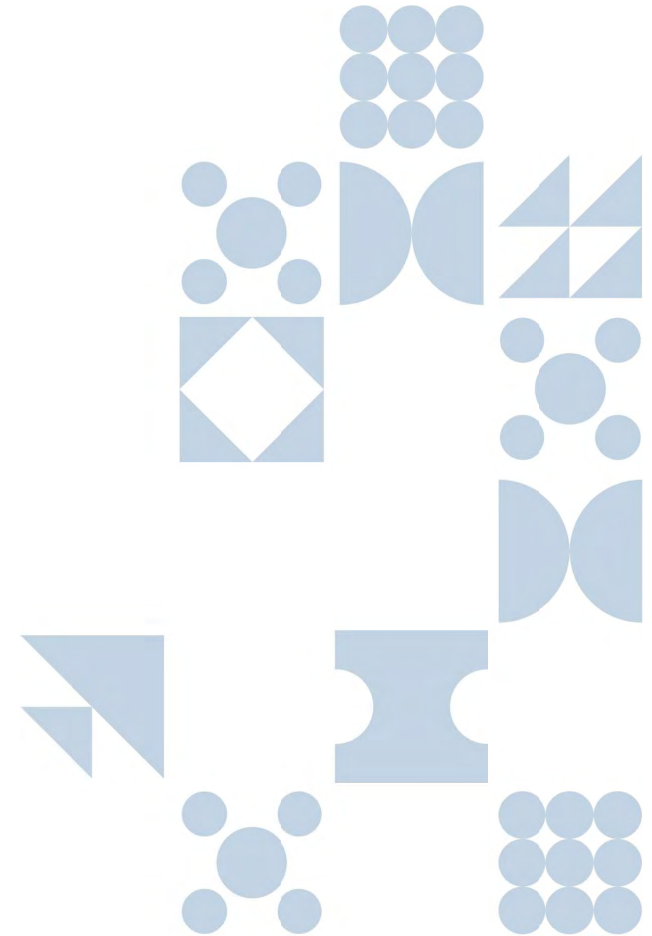



Benefits Realization

TOPIC B

Early and Long-Term Benefits Realization

Some benefits are immediate while others could take a few months to years!

Benefits accrue at various stages depending on:

- Project life cycle used
- Nature of the project work
- Intended outcomes



Can you identify a type of project in which value is delivered very early?

And a project in which value is delivered months or even years after transition?

Benefits Transition and Sustainment Responsibilities

- Handover/transition
- Review of the **benefits management plan**

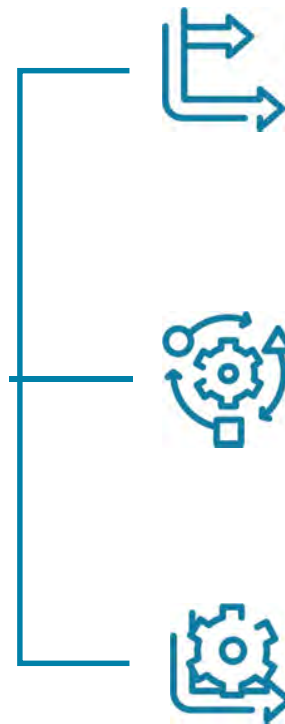

Any improvement or modification to delivered benefits is a new project

Any improvements or modifications to delivered benefits are proposed as work for the next/future iteration and placed/reprioritized on the backlog

Organizations and teams tailor solutions for benefits realization and sustainment — e.g., post-implementation support (aka “**DevOps**” or “hypercare”)

BENEFITS MANAGEMENT PLAN

The documented explanation defining the processes for creating, maximizing, and sustaining the benefits provided by a project or program. It also describes how and when the benefits of a project will be derived and measured. Both the business case and the benefits management plan are developed with the benefits owner prior to the project being initiated. Additionally, both documents are referenced after the project has been completed. Therefore, they are considered business documents rather than project documents or components of the project management plan.

DevOps

A collection of practices for creating a smooth flow of delivery by improving collaboration between development and operations staff.

Sustainment



Any improvement or modification to delivered benefits is a new project





Any improvements or modifications to delivered benefits are proposed as work for the next/future iteration and placed/reprioritized on the backlog



Organizations and teams tailor solutions for benefits realization and sustainment — e.g., post-implementation support (aka “**DevOps**” or “hypercare”)

Benefits Transition and Sustainment

An Explanation

Project Team	Customer 	Product Owner or Project Manager  
Delivers benefits to customer organization	<ul style="list-style-type: none"> Ensures continued generation of improvements and delivered benefits Captures additional customer inputs 	Works with customer to identify work required for desired improvements
Provides planned performance data	Compares actual performance to planned performance, including KPIs	Uses metrics chosen with team to measure performance
Works with business owner to suggest benefits realization metrics, including frequency and monitoring responsibilities	Implements benefits realization metrics at suitable intervals, tailored to needs	Collaborates with team to determine suitable metrics
Determines if any remaining risks might prevent benefit achievement	<ul style="list-style-type: none"> Identifies risks, processes and tools needed to ensure continued benefits realization Monitors risks affecting delivered benefits 	Monitors risks on impediments log and collaborates with team about response
Provides technical information required to use the product or service	Updates technical information – e.g., FAQs	Collaborates with team to update technical information

Benefits Management Plan

A **business document** developed by the organization to define potential benefits from the project effort

- Is a major input to authorizing the project
- Examines the requested benefits and determines if both the tangible and intangible business value will be realized from the project
- Determines the time frame for short- and long-term benefits realization
- Identifies a benefits owner responsible for achieving the benefits, including:
 - Metrics or measurements to be used
 - Which individuals or groups measure results



In the plan, determine whether any remaining project risks might prevent benefit achievement.



When key stakeholders are identifying desired project benefits, let them suggest how the benefits should be measured.



BUSINESS DOCUMENT

An artifact developed prior to the project, used as part of the business case, and which is reviewed periodically by a project professional to verify benefit delivery.

- Is a major input to authorizing the project
- Examines the requested benefits and determines if both the tangible and intangible business value will be realized from the project
- Determines the time frame for short- and long-term benefits realization
- Identifies a benefits owner responsible for achieving the benefits, including:
 - Metrics or measurements to be used
 - Which individuals or groups measure results



In the plan, determine whether any remaining project risks might prevent benefit achievement.



When key stakeholders are identifying desired project benefits, let them suggest how the benefits should be measured.

Benefits Owner

- Works with project manager/team lead during the project to ensure planned benefits are managed as they are delivered
- Assists in transitioning the requested benefits to the receiving organization
- Ensures that measurement metrics and methods are established and monitored
- Reports to management on the realized results (value) of the delivered benefits



A benefits owner may be a business analyst, sponsor or operations manager.



The product owner is responsible for making sure project work reaps benefits for the organization.

Verify Benefits Realization



-
- Using the chosen metrics, the product owner reports on progress for each tangible benefit
 - For intangible benefits, a subjective (qualitative) determination may be more useful
 - Reporting should include:
 - For tangible benefits—progress toward being met
 - Any benefits at risk of not being realized as planned
 - Any resulting negative impact on strategic objectives
 - Potential ending of the project team’s support



In a predictive project, once the transition is complete, who is responsible for verifying that benefits are realized?

ECO Coverage

3.2 Evaluate and deliver project benefits and value

- Document agreement on ownership for ongoing benefit realization (3.2.2)
- Verify measurement system is in place to track benefits (3.2.3)

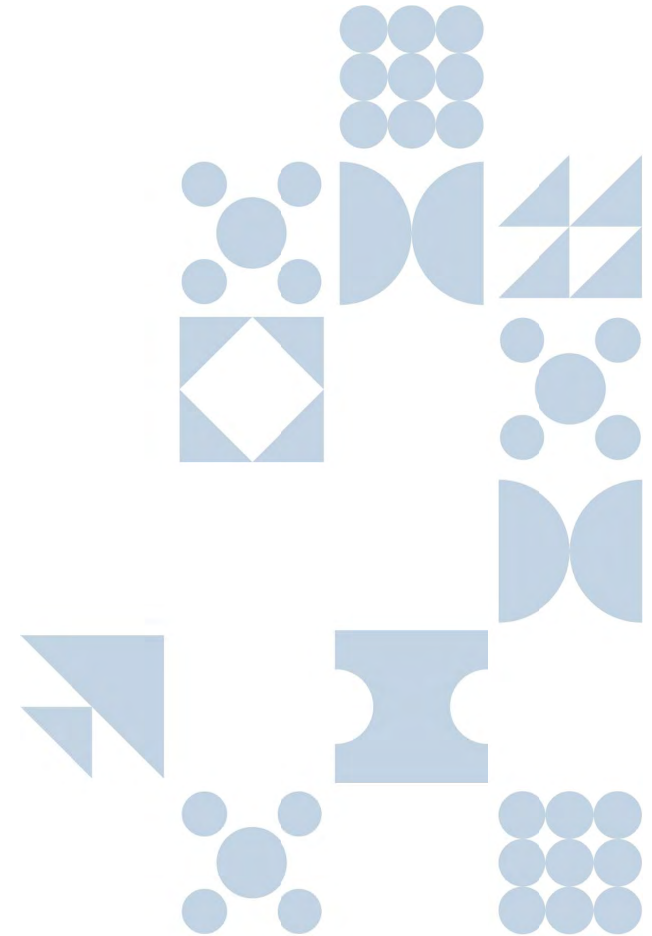



Knowledge Transfer

TOPIC C

Knowledge Management During Closing

- **Conduct retrospectives** or final **lessons learned** meetings
- **Archive** all project information
- **Finalize lessons learned register**
- **Add** the lessons learned to the knowledge management/**lessons learned repository**
- **Transition** knowledge from project team to the customer



gement

LESSONS LEARNED REGISTER

A project document used to record knowledge gained during a project. The knowledge attained can be used in the current project and entered into the lessons-learned repository for subsequent use.

LESSONS LEARNED REPOSITORY

A central store of historical lessons learned information from various projects across jurisdictions.

final **lessons**

on

gister

he knowledge
ed repository

project team to



Conduct Project Retrospective



-
- Internalize learning about the work product and process
 - Capture key successes and challenges
 - Consider qualitative (people’s feelings) and quantitative (measurements) data
 - Use data to find root causes, design countermeasures, and develop action plans for next time
 - Praise, congratulate and motivate the team



An agile team might conduct a final retrospective, while a project manager holds a final “all-hands” meeting for the team in a predictive life cycle. These are similar ceremonies for closing a project or phase.



Finalize Lessons Learned

Include the following topics from the project's lessons learned register in the final report:

- Scope changes
- Schedule impacts
- Risks and issues
- Stakeholder relationships
- Vendor relationships
- Artifacts
- Recommendations

Consolidating Lessons Learned

The following categories of lessons learned information are especially important at the end of a project:

- Scheduling
- Conflict management
- Sellers
- Customers
- Strategic
- Tactical

Transfer these into the **lessons learned repository**.



Final Report: Summary of project/phase performance result



Description	Describe activity undertaken, including deliverables or milestones
Scope objectives	Document scope evaluation criteria and give evidence of met completion criteria
Quality objectives	Describe evaluation criteria for project and product quality. Verify objectives are met, give actual milestone delivery dates and reasons for any variances
Cost objectives	Restate acceptable cost range, give actual costs and reasons for any variances
Validation information	Include required approvals for final product, service or result—e.g., user satisfaction survey results
Schedule objectives	Verify project objectives were completed on time; report on any variance and effects of the variance
Benefits realization	State how the final product, service or result achieved the business needs and expected benefits; if partial, give details of variance and fulfillment schedule
Risks or issues encountered	List risks and issues and state how they were addressed

ECO Coverage

2.16 Ensure knowledge transfer for project continuity

- Confirm approach for knowledge transfers (2.16.3)

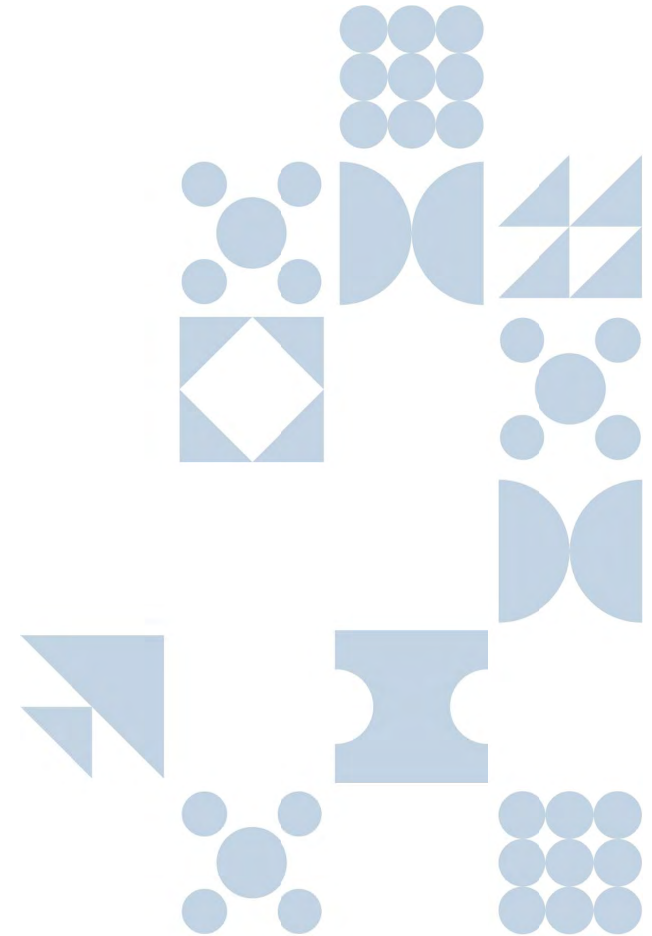

Don't Hesitate – Accelerate Earn Your PMP Certification

With your knowledge, experience leading projects, and the 35 hours of training you've completed, you are eligible and prepared for PMP exam success!

[Start or Continue your PMP Application Today](#)



©2023 Project Management Institute, Inc. All rights reserved.
This material is being provided as part of a PMI® course.

End of Lesson 6

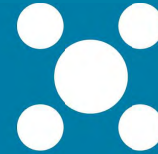

PMP® Boot Camp Plus Program

Next Steps

Next Steps – Overview

NEXT STEPS

1. Your certificate will be issued if you completed the requisite 35 contact hours of attendance, as verified by your instructor.
2. Following class completion, you will have access to this survey in your Vets2PM Student Portal, titled “PMP Course Certificate and Survey”. Completion and submission of this survey is what triggers access to your certificate of completion for the course; you will have immediate access to it to save as a pdf file.
3. If you have not already submitted your application for approval by PMI, we recommend doing so as soon as possible.

HOW TO APPLY ON PMI

1. Go to www.pmi.org
2. Go to Certifications
 - a. PMP - <https://www.pmi.org/certifications/project-management-pmp>
 - b. CAPM - <https://www.pmi.org/certifications/certified-associate-capm>
3. Login or Create Your Account
4. In the upper right-hand corner, there should be “Apply Now For Your XXXX”; Select it
5. Complete and submit your application
6. 3-5 days is typically required for approval
7. If you are audited, please:
 - a. Review all audit comments and attempt to rectify any issues (i.e. submit certificate or adjust application)
 - b. If your response is rejected, please email all documents and audit rejection to garrik@vets2pm.com
8. When your profile says “You may submit payment” or “You may schedule your exam”, your application has been approved!
9. If you funded your exam with Vets2PM, please:
 - a. Login to your student portal and complete the course titled “**Complete to Retrieve Your PMI Exam Voucher**”
 - b. This will enter you into a payment queue
 - c. If you are having technical issues, please use the chat function of www.vets2pm.com or email hello@vets2pm.com

Next Steps – Certificate of Completion

- Please provide us with *feedback* of your experience by writing out your thoughts!
- You will receive your *Certificate of Completion* via download upon submission of your course survey
 - If you do not, please email garrik@vets2pm.com

SkillBridge Certificate and Survey

Project Management Fundamentals

Vets2PM Professional Scrum Master (PSM I) Boot Camp+

PMP Course Certificate and Survey

Intellectual Point PMP Course Survey and Certificate

Certified Manager Video Course Add-On – How To Speak Civilian Fluently and Prove It With Your CM!

Vets2PM PMP® Boot Camp Plus Program



Next Steps - Apply

- Create an account at pmi.org
- Initiate a PMP® application
- Use the ***Application Completion Tool**** to consolidate and record your PM experience
 - (If audited) Complete audit instructions
 - Contact us for *free* audit defense
 - (If rejected) Complete correction instructions
 - Contact us for *free* application correction
- Upon acceptance, schedule your PMP® exam
 - Recommended to test within 4 weeks of completing this course *and* the 30-Day Study Plan



* The Application Completion Tool is provided for *free* as part of your Vets2PM membership, and is found on your Vets2PM Student Portal

Next Steps - Study

- Vets2PM Student Portal
 - On-Demand PMP® Exam Crash Course
 - Videos, Project Manager Essential Toolbox (PMET), exam-prep questions, etc.
 - Vets2PM PMP Application Course
 - The Application Completion Tool (ACT)
 - Many other *free* materials to facilitate your success!
- Project Management Institute (PMI®)
 - PMBOK Guide 7th Edition
 - “Project Management Body of Knowledge Guide”
 - Project Management Professional Exam Content Outline (PMPECO)
 - PMI.org (articles, standards, publications, etc.)

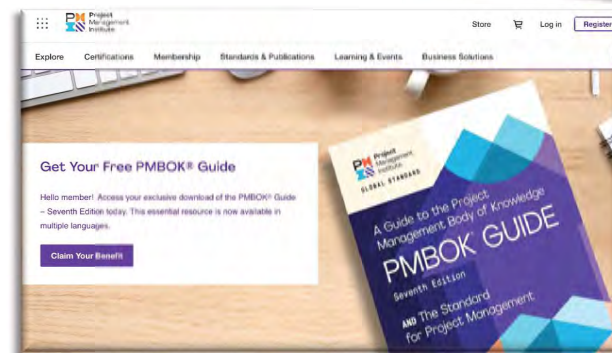
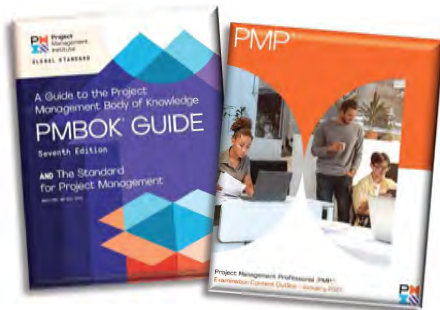
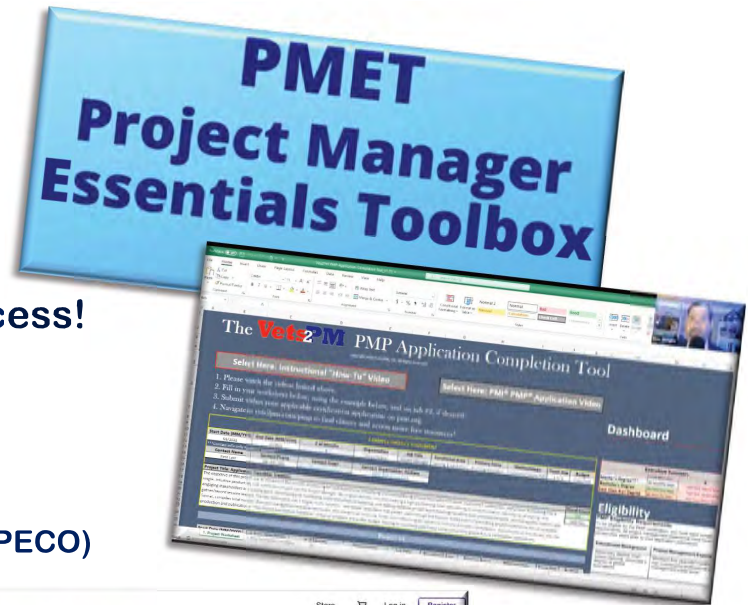

Next Steps – Practice Exam Questions



 My Student Portal

 Logout

[Courses & Certifications](#)

[Get Training & Free Resources](#)

[Student Portal](#)

[DoD SkillBridge/CSP](#)

[Job Seekers](#)

[Talent Services](#)

PMPv3 Lesson 0 Topic C Study Guide Overview

PMI ATP PMP Exam Prep Questions

1 Quiz

 Collapse

 Lesson Content

 PMI ATP PMP Exam Prep Questions

PMPv3 Lesson 1 Business Environment



3 Lesson 1 Topic A Foundation

Copyright 2023, Vets2PM, LLC. All rights reserved.

Next Steps – Career Enhancement



Vets2PM Career Services

Job Opportunities | SkillBridge | Resume Writing | Interview Skills | LinkedIn Optimization

Complete your profile. You are already in our system, but we need more information to assist you when it comes time to transition out of the military. Simply go to our job board at <https://vets2pm.com/job-board> and click on the 'Join Candidate Database' to complete the form so we know what branch of the military you are in, when you are transitioning, location you are interested in, etc. This way, when the time comes, we can help you find a job!

SkillBridge. If you are interested in a SkillBridge internship we have 100+ host companies and many opportunities. Complete our SkillBridge interest form now or when you get closer to your transition date. We will help you find the right internship! Complete the form at: <https://vets2pm.com/skillbridge>

Resume Writing. In your Student Portal you have access to our Resume Optimization Video, a resume template, and a full-service option via the Resume Builder form. Watch the video first and then use the template for a 'self-help' option or complete the Resume Builder Form for a full-service option.

Interview Skills & LinkedIn Optimization. In your Student Portal is an Interview Skills course – take it to optimize your interview skills when you are nearing your transition. We also have a LinkedIn Optimization video to help you optimize your LinkedIn profile to appeal to companies for your job search. There are invaluable tips, content, and suggestions to help you transition into a meaningful, lucrative, post-service career!

Use these services to earn a **meaningful, lucrative, post-service career** through your affiliation with Vets2PM.

Do you have questions? Contact any of the Career Services Team:

Cathy Miclat – cathy@vets2pm.com | Bridgett Manning – bridgett@vets2pm.com | Jessica Boswell – Jessica@vets2pm.com



Next Steps – Contact Us!

Courses & Certifications

Get Training & Free Resources

Student Portal

DoD SkillBridge/CSP

Job Seekers

Talent Services

FAQs

Blog

PMP® & CAPM®

PMI-ACP®

Master Project
Leadership
Workshop

Scrum Master

Certified Manager

aPHR®

Cyber Professional

Get PDUs

Project Manager
Essential ToolBox
("PMET")

Subscription



Eric

Founder & CEO



Kelly

Director of Staff



Jeremy

Chief Operations Officer



Cathy

Director of Career Services



Garrik

Lead Instructor

Access to Proven Certification Training

SkillBridge Internship & Job Opportunities

Talent Services

Contact us! (First name... @vets2pm.com)

A close-up, slightly angled view of an American flag. The blue canton with white stars is on the left, and the red and white stripes are on the right. The flag has a textured, possibly embroidered or quilted appearance.

Thank You!

PMP® Boot Camp Plus Program

Study Guide

Vets2PM Study Guide

This Study Guide is provided by Vets2PM®, and is intended to be employed upon completion of the Vets2PM® PMP® Boot Camp Plus Program, a 35-Hour live course (virtual or on-site).

Included are PMP® Exam preparation reminders, tips, approaches to consider, as well as a 30-Day Study Plan, which is designed to guide you to exam success, from after your class until exam-day.

The material in this section is for your consideration only, and is no substitute for genuine effort in preparing for the exam, which only you can gauge. Our team is here to assist you in all feasible ways to pass the exam, so feel free to reach out for needed support!

Email our Lead Instructor for assistance at garrik@vets2pm.com.

PMP® Exam & The PMBOK® Guide

A manual published by PMI® that contains:

An ANSI Standard for delivering projects in any environment/industry

A guideline that project managers can use to assist in forming and implanting project plans

A contemporary collection of good and emerging practices to successfully manage projects

The PMP® Exam is not based on the (current) PMBOK® Guide, rather on the (current) PMP® Exam Content Outline (ECO). Any document supporting the tasks within the ECO are helpful for studying for the PMP® Exam.

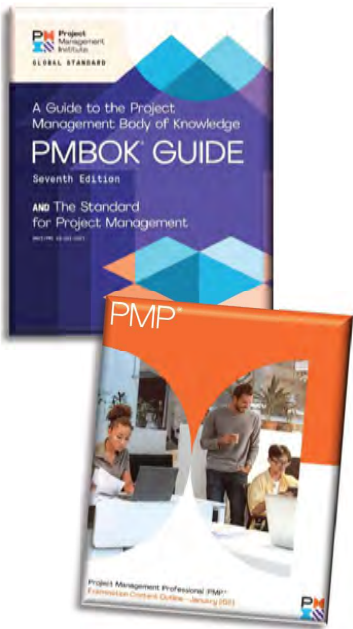

PMP® Exam Execution

- 180 total questions, 230 minutes
 - 175 scored
 - 5 unscored (“pre-test”)

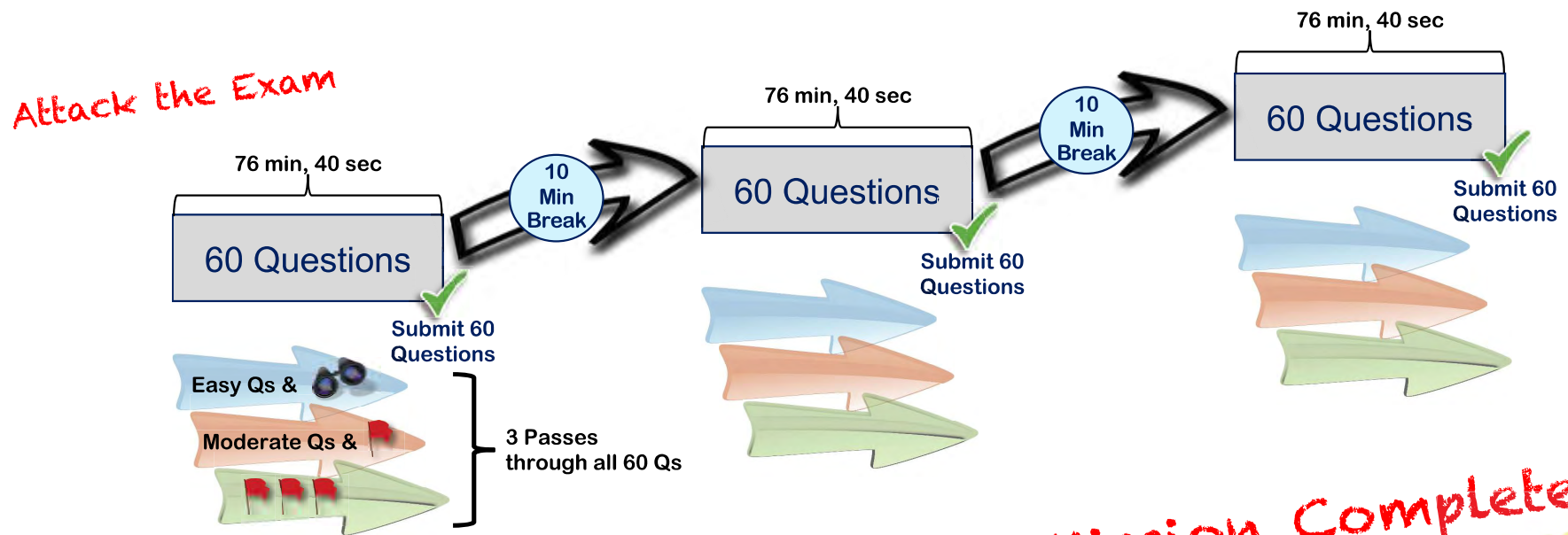

PMP® Exam Approach

How PMI® sees us as PMs

- The “lens” through which to view exam questions

Mindset of the PM:

- Selfless service
- “The buck stops with you”
- 90% of your time is spent communicating (meetings, SMEs, reporting status, etc.)
- Planning is key, the WBS is the key planning document, so every project has a WBS
- Balanced approach to conflict management, negotiation, leadership style, etc.
- Always observe before making a decision (respond, don’t react)
- Proactive, not reactive

Exam Assumptions:

- You are assigned to a large, complex project for a large organization by a large organization
- Multi-year schedule and million+ dollar budget
- Numerous, global Stakeholders
- You are assigned before the project work begins, stakeholders are engaged, and roles/responsibilities are clearly defined and known
- You have appropriate time to plan and make decisions prior to executing
- A Project Management Office (PMO) is present and active
- You continuously influence stakeholders, changes, risks, root causes, and outcomes
- You are always looking for small, incremental improvements
- The project is not done until “all of the tools are put away”

PMP® Exam Decision-Making Model

PM decision-making model:

- 1) A problem is posed
- 2) Determine approach (predictive, adaptive, hybrid)
- 3) **Confirm that the problem exists**
- 4) **Assess options for resolving the problem**
- 5) Choose an option
- 6) Execute the option
- 7) **Assess whether the desired effect has been achieved**
- 8) ... back to 1: is a problem still being posed...

Determine where you are on this model for each exam question to help you determine "the next best step."

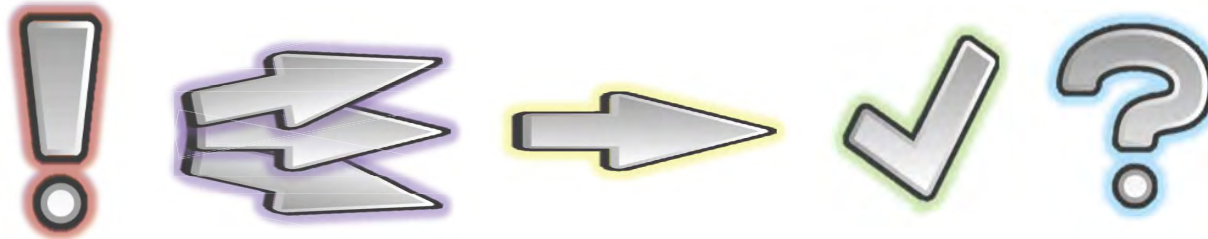

PMP® Exam Studying

This PMP® Exam crash course is intended to be intense

- High volume of material
- Moderate complexity

We recommend 30 days of studying *after* completion of this course

- Use the 30-Day Study Plan; tailor length of time as needed
- Review course videos and materials; heavy focus on exam-prep questions
 - 2-3 hours per day
 - 5-6 days per week
 - 3-5 weeks

Life circumstances will vary, therefore your studying path will, too!

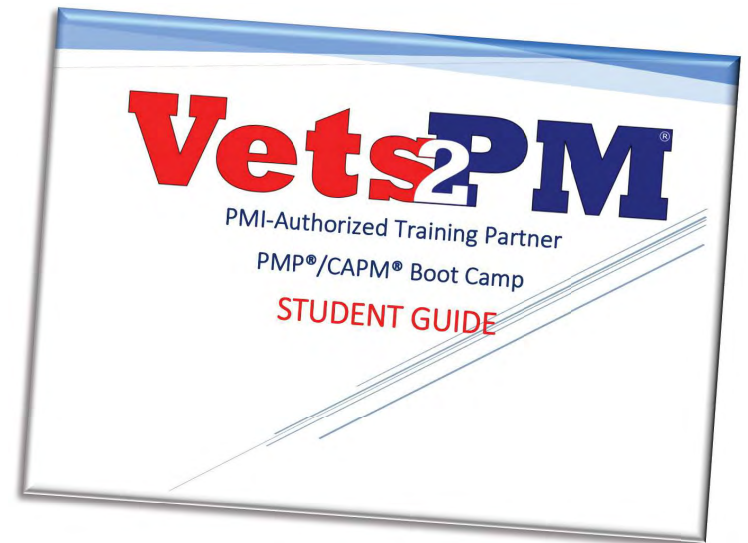

Study Plan Overview

In completing your Vets2PM PMP®/ CAPM® *Boot Camp Plus* course, you have established a firm foundation of knowledge, but much more preparation is needed for ultimate success on the PMP®/ CAPM® Exam.

You will need to implement focus, discipline, and a structured plan to best prepare for this exam. To facilitate effective progress and preparedness, it is recommended to completely immerse yourself in the course material for about **2-3 hours per day, 5-6 days per week, for 4-8 weeks** after completing the boot camp course.

The following benchmarks are vital in passing the PMP®/ CAPM® exam:

- Attend an Authorized Training Partner 35-hour Boot Camp**
- Read the PMI® Authorized PMP® Exam Prep book (student workbook) cover-to-cover**
- Read the PMI® PMP® Glossary a minimum of three times**
- Review all PMI® Topic Activities, Lesson Mastery Builders, and Pre/Post-Class Assessments**
- Complete a minimum of 1,000 exam-prep questions (the following 30-Day Study Plan guides you to complete 1,000)**
- Immerse yourself in mastering the course content for a minimum of 3 weeks following class**

After training thousands of students, we have found that those students not achieving these pre-exam benchmarks fail their PMP® exams on their first attempt.

Study Plan Tailoring

In certain environmental conditions, at-home online testing may be offered by PMI®. In these cases, some special considerations have been found useful in planning to take the PMP®/CAPM® exam in a digital environment:

- Consider that the exam window automatically expands to fill the computer monitor; no other windows may be opened during the exam
- Take the time to conduct the exam tutorial, if provided, as shortcuts and tips are shown which may prove useful
- While *knowing* the “brain dump” is a helpful tool for instilling information in your mind, it may not be feasibly drawn on the provided exam scratch documents/digital whiteboard; memorization may still prove useful
- As with onsite testing centers, speaking aloud (or covering your mouth) may not be permitted in the digital exam-taking environment, as it is proctored live by specialists; consider practicing exam questions silently, with mouth uncovered
- Be familiar with adjusting computer monitor brightness, as the exam window is mostly white and may be straining to view for the exam duration

The following 30-day study plan is the daily study regimen you’ll need to follow to help you achieve maximum results and pass the PMP®/CAPM® exam. It is suggested that you spread this plan over the course of your day. Immersion is *vital* for effective preparation. You can achieve this in several ways: flashcards, smartphone applications, student study guides, additional (free) attendance to courses (unlimited access), PMI® meetings, and more!

This study plan is only a starting point, and you should modify it to best fit your personal schedule, focus areas, and the date of your PMP®/CAPM® exam (recommended to be scheduled within 90 days of the Vest2PM PMP®/CAPM® Boot Camp course completion date).

Study Plan

**All reading material below references the PMI® Authorized PMP® Exam Prep book (student workbook), unless otherwise noted*

Course Introduction & Lesson 1: Business Environment

Day 1

- Watch PMI® Spotlight videos (You, Staying Certified, The Project Economy, Preparing for the PMP® Exam)
- Take all available PMI® Mastery Builders (Found on the PMI® Resource Locker at pmi.lochoice.com) and exam-preparation questions (found with the Course Content videos)
- Create Brain Dump
- Complete 20 exam-prep questions (from any source)

Day 2

- Complete Mastery Builder 1 (record score)
- Read Topics A-C in the Student Workbook & watch associated Course Content
- Watch PMI® Spotlight video for Topic A (Successful Persuasion)

Day 3

- Write/draw Brain Dump twice
- Complete Activities for Topics A-C
- Read Glossary pages 1-8 (Found on the PMI® Resource Locker at pmi.lochoice.com)
- Complete 20 exam-prep questions (from any source)

Day 4

- Read Topics D-F in the Student Workbook & watch associated Course Content
- Complete 30 exam-prep questions (from any source)

Day 5

- Write/draw Brain Dump twice
- Complete Activities for Topics D-F
- Read Glossary pages 9-16
- Complete 30 exam-prep questions (from any source)

Day 6

- Complete Mastery Builder 1 (assess score)
- Complete 30 exam-prep questions (from any source)

Study Plan

Lesson 2: Start the Project

Day 7

- Write/draw Brain Dump twice
- Complete Mastery Builder 2 (record score)
- Complete 30 exam-prep questions (from any source)

Day 8

- Read Topics A-B in the Student Workbook & watch associated Course Content
- Watch PMI® Spotlight video for Topic A (Communication Channels) and Topic B (Using Social Skills to Build Relationships, Tuckman's Ladder of Team Development, Virtual Teams)

Day 9

- Write/draw Brain Dump twice
- Complete Activities for Topics A-B
- Read Glossary pages 17-23
- Complete 40 exam-prep questions (from any source)

Day 10

- Read Topics C-D in the Student Workbook & watch associated Course Content
- Watch PMI® Spotlight video for Topic D (When to Apply Agile Methodologies, Iterative Way of Working)

Day 11

- Write/draw Brain Dump twice
- Complete Activities for Topics C-D
- Read Glossary pages 24-30
- Complete 50 exam-prep questions (from any source)

Day 12

- Complete Mastery Builder 2 (assess score)

Study Plan

Lesson 3: Plan the Project

Day 13

- Write/draw Brain Dump twice
- Complete Mastery Builder 3 (record score)
- Complete 50 exam-prep questions (from any source)

Day 14

- Read Topics A-C in the Student Workbook & watch associated Course Content
- Watch PMI® Spotlight video for Topic B (MVP or MBI) and Topic C (Working with the Critical Path, Planning Poker)

Day 15

- Write/draw Brain Dump twice
- Complete Activities for Topics A-C
- Read Glossary pages 31-37
- Complete 50 exam-prep questions (from any source)

Day 16

- Read Topics D-H in the Student Workbook & watch associated Course Content
- Watch PMI® Spotlight video for Topic D (RACI Chart Creation), Topic F (Identifying Project Risks)

Day 17

- Write/draw Brain Dump twice
- Complete Activities for Topics D-H
- Read Glossary pages 38-44
- Complete 50 exam-prep questions (from any source)

Day 18

- Complete Mastery Builder 3 (assess score)

Study Plan

Lesson 4: Lead the Project Team

Day 19

- Write/draw Brain Dump twice
- Complete Mastery Builder 4 (record score)
- Watch PMI® Spotlight video for Lesson 4 (Leading Without Authority)

Day 20

- Read Topics A-D in the Student Workbook & watch associated Course Content
- Complete 50 exam-prep questions (from any source)

Day 21

- Write/draw Brain Dump twice
- Complete Activities for Topics A-D
- Read Glossary pages 45-51
- Complete 50 exam-prep questions (from any source)

Day 22

- Read Topics E-G in the Student Workbook & watch associated Course Content
- Watch PMI® Spotlight video for Topic E (Handling Pressure from Outside Your Team) and Topic G (Dealing with Difficult People)

Day 23

- Write/draw Brain Dump twice
- Complete Activities for Topics E-G
- Read Glossary pages 52-58
- Complete 60 exam-prep questions (from any source)

Day 24

- Complete Mastery Builder 4 (assess score)
- Complete 60 exam-prep questions (from any source)

Study Plan

Lesson 5: Support Project Team Performance

Day 25

- Write/draw Brain Dump twice
- Complete Mastery Builder 5 (record score)
- Read Topics A-B in the Student Workbook & watch associated Course Content
- Watch PMI® Spotlight video for Topic A (Kaizen)
- Complete Activities for Topics A-B
- Read Glossary pages 59-63
- Complete 180 exam-prep questions (from any source)

Day 26

- Read Topic C in the Student Workbook & watch associated Course Content
- Watch PMI® Spotlight video for Topic C (Project Status Reports, Information Radiators)
- Complete Activities for Topic C

Day 27

- Write/draw Brain Dump twice
- Read Topics D-E in the Student Workbook & watch associated Course Content
- Read Glossary pages 64-68
- Complete Mastery Builder 5 (assess score)
- Complete 200 exam-prep questions (from any source)

Study Plan

Lesson 6: Close the Project/Phase

Day 28

- Complete Mastery Builder 6 (record score)
- Read Topics A-C in the Student Workbook & watch associated Course Content
- Complete Activities for Topics A-C
- Read Glossary pages 69-75

Day 29

- Write/draw Brain Dump twice
- Complete Activities for Topics A-C
- Read Glossary pages 76-81
- Complete Mastery Builder 6 (assess score)
- Complete 100 exam-prep questions (from any source)

Day 30

- Write/draw Brain Dump twice
- Watch PMI® Spotlight video (Preparing for the PMP® Exam)
- Take all available PMI® Mastery Builders and exam-preparation questions (found after the Course Content videos)
- Complete 200 exam-prep questions (from any source)

Study Plan

PMP®/ CAPM® Exam Day

- Arrive at the testing center at least 45 minutes early
- Write/draw Brain Dump once
- Skim through glossary if you have time
- During the exam, answer all 60 questions, then we recommend taking advantage of the optional 10-minute break to get a period of recovery. Remember, there is no penalty for guessing, so be sure to answer each question (e.g. don't leave any blank). It is normal to use most of the allotted time for the exam, so control your pace by using three passes through each section of the exam: first pass (easy questions), second pass (moderate questions, flagging those you will need more time on), third pass (difficult/flagged questions).

Brain Dump

This document references a single sheet of paper used to draw/write all memorized information in preparation for the exam. This is a personalized document, created during the study process, and used specifically to facilitate memorization and recollection of certain information, which will likely aid in answering several question types more quickly. You may wish to include information such as earned value formulas, names and styles of charts, theories/theorists, etc. for memorization... anything that you sense will not be easily recalled during the exam. Whether you will be able to draw/write this memorized document during the exam will depend on test-taking center procedures, provision of note-taking materials, changes in exam policies, and other unknown environmental conditions. Regardless, it is recommended to memorize and use this document during the study process, as the mental organization and rumination of the material on the brain dump can only facilitate positive results on the exam.

Brain Dump

PMP® Exam “Brain Dump”

This document is subjective, so add what *you* think would be beneficial to memorize for the exam on your personal study version!

Formulas

Earned Value Management (EVM)

Planned Value (PV) = Cost Baseline at a certain date
 Earned Value (EV) = % work completed x PV
 Actual Cost (AC) = Money spent at a certain date

Budget At Completion (BAC) = sum of all budgets
 Estimate at Completion (EAC) = BAC / CPI

Schedule Variance (SV) = EV - PV
 Schedule Performance Index (SPI) = EV / PV
 Cost Variance (CV) = EV - AC
 Cost Performance Index (CPI) = EV / AC
 •SV/CV: + is good, 0 is on plan, - is bad
 •SPI/CPI: ≥1 is good, 1 is on plan, ≤1 is bad
 Estimate to Complete (ETC) = EAC - AC

Expected Monetary Value (EMV)

Probability of occurrence (%) x monetary impact (\$)

Communications Channels

$$\frac{N(N-1)}{2}$$

N = total number of stakeholders in a project (including the PM)



Theory

Organizational Theory

Tuckman's Ladder



Herzberg's 2-Factor Theory

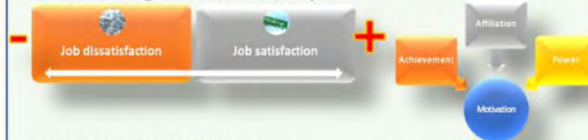

McGregor's X / Y Theory



Vroom's Expectancy Theory

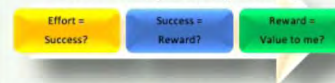

Ouchi's Theory Z



Fiedler's Contingency Theory



Quality Theory

W. Edwards Deming
 Joseph M. Juran
 Philip Crosby

Maslow's Hierarchy of Needs



McClelland's Human Motivation Theory



Agile

Positions

Project Manager
 Product Owner
 Scrum Master

Ceremonies

Daily Standup/Daily Scrum
 Iteration/Sprint Planning
 Iteration/Sprint Review
 Iteration/Sprint Retrospective

Agile Release Planning

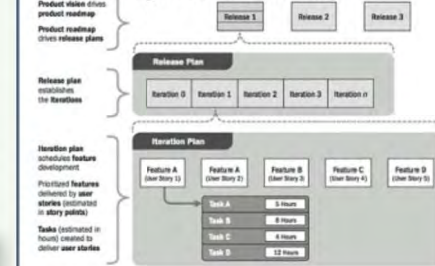

Miscellaneous

Sigma Accuracy Values

1 sigma = 68%
 2 sigma = 95%
 3 sigma = 99.7%
 6 sigma = 99.9997%

Methodologies

Predictive
 Agile
 Iterative
 Incremental
 Hybrid

Code of Ethics and Professional Conduct (COEPC)

Responsibility
 Respect
 Fairness
 Honesty

Consensus Techniques

Fist of Five
 Roman Voting
 Polling
 Dot Voting

